

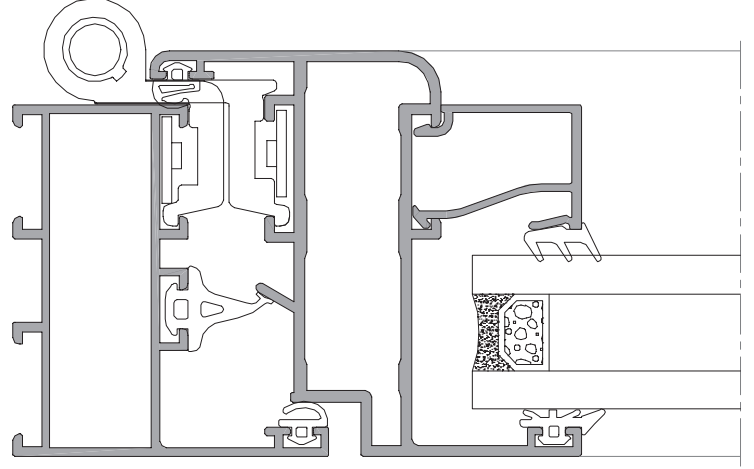

Kapı - Pencere Sistem  
Door - Window System



# WD55



#### TEKNİK ÖZELLİKLER / TECHNICAL PROPERTIES

KASA DERİNLİĞİ / FRAME DEPTH	55 mm ve 60 mm (Oval Kasa)
KANAT DERİNLİĞİ / SASH DEPTH	63,5 mm
ET KALINLIĞI / WALL THICKNESS	1.5 mm - 1.8 mm - 2 mm
MAKS. CAM KALINLIĞI / MAX GLASS THICKNESS	4 mm - 36 mm
ISI YALITIM DEĞERİ / THERMAL INSULATION VALUE (UF)	EN 10077-2 : 6.20 - 6.70 W / ( m <sup>2</sup> . K )



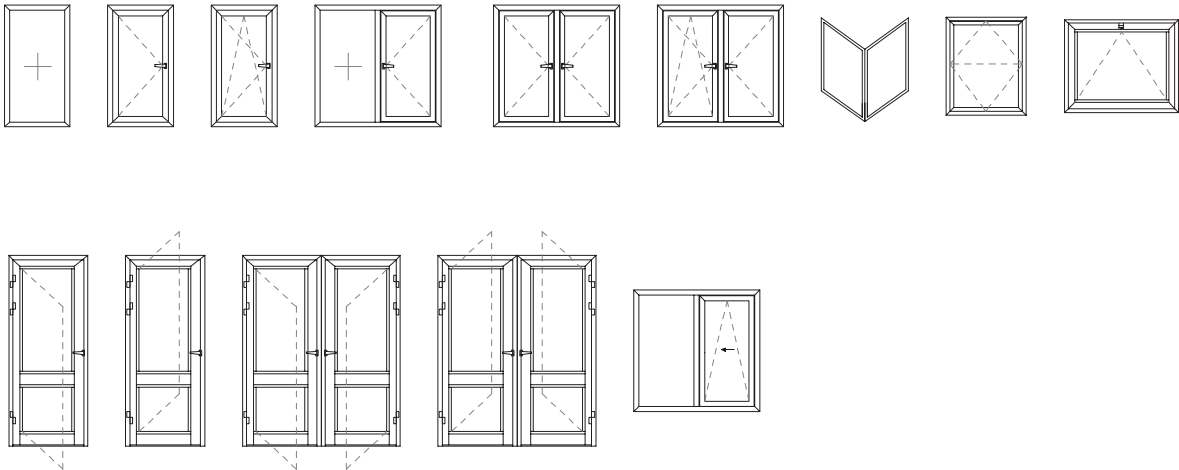

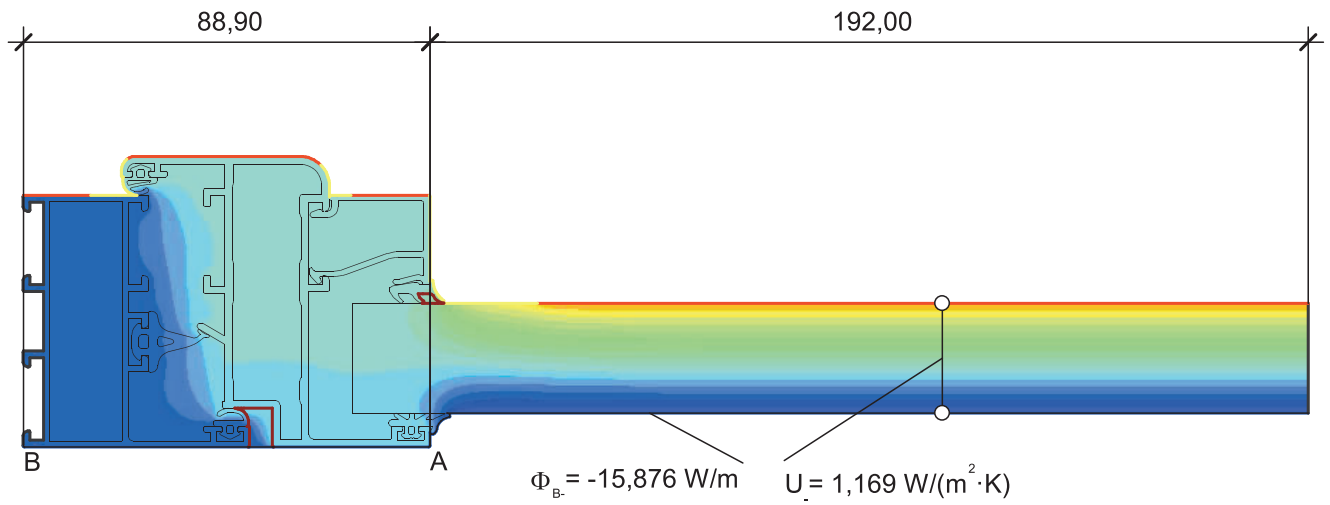

















#### UYGULAMA SEÇENEKLERİ / APPLICATION OPTIONS













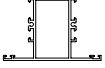
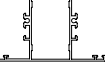
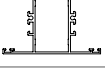
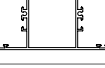



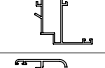
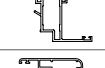

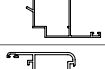

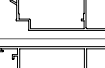
$$U_{f,A,B} = \frac{\frac{\Phi}{\Delta T} - U_p \cdot b_p}{b_f} = \frac{\frac{15,876}{20,000} - 1,169 \cdot 0,192}{0,089} = 6,41 \text{ W/(m}^2 \cdot \text{K)}$$



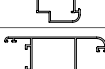
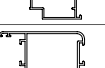
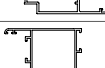









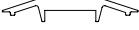
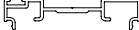
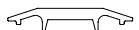





Material	$\lambda[\text{W}/(\text{m} \cdot \text{K})]$	$\varepsilon$	Boundary Condition	$q[\text{W}/\text{m}^2]$	$\theta[\text{C}]$	$R[(\text{m}^2 \cdot \text{K})/\text{W}]$	$\varepsilon$
Aluminium (Si Alloys)	160,000	0,900	Epsilon 0.9				0,900
EPDM (ethylene propylene diene monomer)	0,250	0,900	Exterior, frame	0,000		0,040	
Panel	0,035	0,900	Interior, frame, normal	20,000		0,130	
Slightly ventilated air cavity	anisotropic		Interior, frame, reduced	20,000		0,200	
Undefined Material	0,010		Symmetry/Model section	0,000			
Unventilated air cavity	anisotropic						

PROFİL KESİTİ PROFILE SECTION	PROFİL KODU PROFILE CODE	PROFİL ADI PROFILE NAME	Jx cm <sup>4</sup>	Jy cm <sup>4</sup>	AĞIRLIK (kg/m) WEIGHT
	1685	KASA PROFİLİ FRAME PROFILE	15,98 cm <sup>4</sup>	5,15 cm <sup>4</sup>	0,902 kg/m
	1780	KASA PROFİLİ FRAME PROFILE	19,64 cm <sup>4</sup>	6,23 cm <sup>4</sup>	1,135 kg/m
	1686	KASA PROFİLİ FRAME PROFILE	20,52 cm <sup>4</sup>	11,23 cm <sup>4</sup>	1,005 kg/m
	1781	KASA PROFİLİ FRAME PROFILE	25,23 cm <sup>4</sup>	13,58 cm <sup>4</sup>	1,269 kg/m
	1687	KASA PROFİLİ FRAME PROFILE	24,35 cm <sup>4</sup>	15,40 cm <sup>4</sup>	1,064 kg/m
	12229	KASA PROFİLİ FRAME PROFILE	27,93 cm <sup>4</sup>	22,96 cm <sup>4</sup>	1,228 kg/m
	1782	KASA PROFİLİ FRAME PROFILE	29,80 cm <sup>4</sup>	18,96 cm <sup>4</sup>	1,347 kg/m
	1905	KASA PROFİLİ FRAME PROFILE	12,50 cm <sup>4</sup>	4,22 cm <sup>4</sup>	0,831 kg/m
	1906	KASA PROFİLİ FRAME PROFILE	15,83 cm <sup>4</sup>	4,86 cm <sup>4</sup>	1,033 kg/m
	1907	KASA PROFİLİ FRAME PROFILE	16,39 cm <sup>4</sup>	11,45 cm <sup>4</sup>	0,934 kg/m
	1908	KASA PROFİLİ FRAME PROFILE	21,75 cm <sup>4</sup>	12,28 cm <sup>4</sup>	1,282 kg/m
	11959	KASA PROFİLİ FRAME PROFILE	16,36 cm <sup>4</sup>	12,65 cm <sup>4</sup>	1,065 kg/m
	1909	KASA PROFİLİ FRAME PROFILE	13,03 cm <sup>4</sup>	19,98 cm <sup>4</sup>	0,993 kg/m
	1910	KASA PROFİLİ FRAME PROFILE	22,12 cm <sup>4</sup>	21,49 cm <sup>4</sup>	1,374 kg/m
	3540	KASA PROFİLİ FRAME PROFILE	20,41 cm <sup>4</sup>	11,65 cm <sup>4</sup>	1,196 kg/m
	12747	KASA PROFİLİ FRAME PROFILE	27,12 cm <sup>4</sup>	38,27 cm <sup>4</sup>	1,462 kg/m
	5580	Z KASA PROFİLİ Z FRAME PROFILE	23,41 cm <sup>4</sup>	8,57 cm <sup>4</sup>	1,110 kg/m
	1790	ORTA KAYIT PROFİLİ MULLION PROFILE	16,70 cm <sup>4</sup>	9,90 cm <sup>4</sup>	1,225 kg/m
	1693	ORTA KAYIT PROFİLİ MULLION PROFILE	13,72 cm <sup>4</sup>	8,80 cm <sup>4</sup>	1,001 kg/m
	5156	ORTA KAYIT PROFİLİ MULLION PROFILE	18,95 cm <sup>4</sup>	14,95 cm <sup>4</sup>	1,314 kg/m
	1694	ORTA KAYIT PROFİLİ MULLION PROFILE	16,53 cm <sup>4</sup>	17,78 cm <sup>4</sup>	1,103 kg/m
	2096	ORTA KAYIT PROFİLİ MULLION PROFILE	91,80 cm <sup>4</sup>	30,85 cm <sup>4</sup>	2,321 kg/m



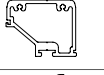

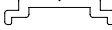

















\*\* Her profil için minimum sipariş 300 kg'dır.  
\*\* Minimum order quantity is 300 kg per profile.

PROFİL KESİTİ PROFILE SECTION	PROFİL KODU PROFILE CODE	PROFİL ADI PROFILE NAME	Jx cm <sup>4</sup>	Jy cm <sup>4</sup>	AĞIRLIK (kg/m) WEIGHT
	1783	ORTA KAYIT PROFİLİ MULLION PROFILE	22,39 cm <sup>4</sup>	21,77 cm <sup>4</sup>	1,489 kg/m
	11960	ORTA KAYIT PROFİLİ MULLION PROFILE	19,80 cm <sup>4</sup>	18,86 cm <sup>4</sup>	1,248 kg/m
	3541	ORTA KAYIT PROFİLİ MULLION PROFILE	20,91 cm <sup>4</sup>	20,85 cm <sup>4</sup>	1,394 kg/m
	1901	ORTA KAYIT PROFİLİ MULLION PROFILE	33,67 cm <sup>4</sup>	23,94 cm <sup>4</sup>	1,499 kg/m
	5520	ORTA KAYIT PROFİLİ MULLION PROFILE	43,70 cm <sup>4</sup>	27,54 cm <sup>4</sup>	1,684 kg/m
	1788	ORTA KAYIT PROFİLİ MULLION PROFILE	94,13 cm <sup>4</sup>	30,07 cm <sup>4</sup>	1,966 kg/m
	4687	ORTA KAYIT PROFİLİ MULLION PROFILE	80,83 cm <sup>4</sup>	29,30 cm <sup>4</sup>	1,648 kg/m
	1691	KANAT PROFİLİ SASH PROFILE	21,45 cm <sup>4</sup>	4,43 cm <sup>4</sup>	0,933 kg/m
	1784	KANAT PROFİLİ SASH PROFILE	25,48 cm <sup>4</sup>	5,25 cm <sup>4</sup>	1,180 kg/m
	12059	PVC KANALLI KANAT PROFİLİ PVC GROOVED SASH PROFILE	30,17 cm <sup>4</sup>	10,23 cm <sup>4</sup>	1,242 kg/m
	1692	KANAT PROFİLİ SASH PROFILE	28,00 cm <sup>4</sup>	9,68 cm <sup>4</sup>	1,039 kg/m
	1785	KANAT PROFİLİ SASH PROFILE	36,60 cm <sup>4</sup>	13,16 cm <sup>4</sup>	1,467 kg/m
	1660	KANAT PROFİLİ SASH PROFILE	57,98 cm <sup>4</sup>	26,80 cm <sup>4</sup>	1,516 kg/m
	1786	KANAT PROFİLİ SASH PROFILE	61,35 cm <sup>4</sup>	40,05 cm <sup>4</sup>	1,820 kg/m
	1787	KANAT PROFİLİ SASH PROFILE	65,32 cm <sup>4</sup>	31,83 cm <sup>4</sup>	1,772 kg/m
	3943	KANAT PROFİLİ SASH PROFILE	54,57 cm <sup>4</sup>	33,87 cm <sup>4</sup>	1,559 kg/m
	3545	KANAT PROFİLİ SASH PROFILE	20,64 cm <sup>4</sup>	15,61 cm <sup>4</sup>	1,052 kg/m
	5158	KANAT PROFİLİ SASH PROFILE	25,00 cm <sup>4</sup>	23,93 cm <sup>4</sup>	1,206 kg/m
	1900	KANAT PROFİLİ SASH PROFILE	45,78 cm <sup>4</sup>	21,39 cm <sup>4</sup>	1,497 kg/m
	5157	KANAT PROFİLİ SASH PROFILE	36,33 cm <sup>4</sup>	14,46 cm <sup>4</sup>	1,206 kg/m
	5519	ETEK PROFİLİ BOTTOM PROFILE	96,80 cm <sup>4</sup>	30,35 cm <sup>4</sup>	1,614 kg/m
	1902	ETEK PROFİLİ BOTTOM PROFILE	120,67 cm <sup>4</sup>	40,40 cm <sup>4</sup>	2,114 kg/m

















\*\* Her profil için minimum sipariş 300 kg'dır.  
\*\* Minimum order quantity is 300 kg per profile.

PROFİL KESİTİ PROFILE SECTION	PROFİL KODU PROFILE CODE	PROFİL ADI PROFILE NAME	Jx cm <sup>4</sup>	Jy cm <sup>4</sup>	AĞIRLIK (kg/m) WEIGHT
	1789	ETEK PROFİLİ BOTTOM PROFILE	269,25 cm <sup>4</sup>	26,92 cm <sup>4</sup>	2,588 kg/m
	1793	PİVOT ADAPTÖR PROFİLİ PIVOT ADAPTER PROFILE	-	-	0,950 kg/m
	1795	ADAPTÖR PROFİLİ ADAPTER PROFILE	-	-	0,638 kg/m
	1794	ADAPTÖR PROFİLİ ADAPTER PROFILE	-	-	0,461 kg/m
	1913	ADAPTÖR PROFİLİ ADAPTER PROFILE	-	-	0,621 kg/m
	1779	ADAPTÖR PROFİLİ ADAPTER PROFILE	-	-	0,439 kg/m
	11925	ADAPTÖR PROFİLİ ADAPTER PROFILE	-	-	1,065 kg/m
	6569	ADAPTÖR PROFİLİ ADAPTER PROFILE	-	-	0,419 kg/m
	9664	KÖŞE DÖNÜŞ PROFİLİ CORNER PROFILE	-	-	0,399 kg/m
	11822	KÖŞE DÖNÜŞ PROFİLİ CORNER PROFILE	-	-	0,981 kg/m
	1792	DIŞA AÇILIR ADAPTÖR PROFİLİ OUTWARD OPENING ADAPTER PROFILE	-	-	0,829 kg/m
	55-4356-4357	KAPI ALTI EŞİK PROFİLİ DOOR THRESHOLD PROFILE	-	-	0,930 kg/m
	1011	DAMLALIK PROFİLİ SILL PROFILE	-	-	0,402 kg/m
	4242	DAMLALIK PROFİLİ SILL PROFILE	-	-	0,094 kg/m
	7021	DAMLALIK PROFİLİ SILL PROFILE	-	-	0,140 kg/m
	12375	DAMLALIK PROFİLİ SILL PROFILE	-	-	0,326 kg/m
	10923	KANAT ALTI KAPAMA PROFİLİ SUB-SASH COVER PROFILE	-	-	0,295 kg/m
	1775	ORTA KAYIT BAĞLANTI PROFİLİ MULLION CONNECTION PROFILE	-	-	1,525 kg/m
	1911	KÖŞE KAPAK PROFİLİ CORNER COVER PROFILE	-	-	0,426 kg/m
	8241	TİJ PROFİLİ STEM BAR PROFILE	-	-	0,099 kg/m
	1755	TİJ PROFİLİ STEM BAR PROFILE	-	-	0,234 kg/m
	1121	T BAĞLANTI PROFİLİ T CONNECTION PROFILE	-	-	0,233 kg/m

\*\* Her profil için minimum sipariş 300 kg'dır.  
\*\* Minimum order quantity is 300 kg per profile.

PROFİL KESİTİ PROFILE SECTION	PROFİL KODU PROFILE CODE	PROFİL ADI PROFILE NAME	Jx cm <sup>4</sup>	Jy cm <sup>4</sup>	AĞIRLIK (kg/m) WEIGHT
	1035	T BAĞLANTI PROFİLİ T CONNECTION PROFILE	-	-	0,240 kg/m
	1139	T BAĞLANTI PROFİLİ T CONNECTION PROFILE	-	-	0,236 kg/m
	1123	T BAĞLANTI PROFİLİ T CONNECTION PROFILE	-	-	0,355 kg/m
	5788	T BAĞLANTI PROFİLİ T CONNECTION PROFILE	-	-	0,205 kg/m
	6414	T BAĞLANTI PROFİLİ T CONNECTION PROFILE	-	-	0,175 kg/m
	3537	CAM ÇITASI (41,5 mm) GLAZING BEAD (41,5 mm)	-	-	0,367 kg/m
	1749	CAM ÇITASI (38,5 mm) GLAZING BEAD (38,5 mm)	-	-	0,356 kg/m
	1750	CAM ÇITASI (38,5 mm) GLAZING BEAD (38,5 mm)	-	-	0,342 kg/m
	1748	CAM ÇITASI (34,5 mm) GLAZING BEAD (34,5 mm)	-	-	0,327 kg/m
	1747	CAM ÇITASI (34,5 mm) GLAZING BEAD (34,5 mm)	-	-	0,340 kg/m
	3536	CAM ÇITASI (31,5 mm) GLAZING BEAD (31,5 mm)	-	-	0,329 kg/m
	3636	CAM ÇITASI (29,5 mm) GLAZING BEAD (29,5 mm)	-	-	0,321 kg/m
	1966	CAM ÇITASI (27,5 mm) GLAZING BEAD (27,5 mm)	-	-	0,314 kg/m
	2236	CAM ÇITASI (26,5 mm) GLAZING BEAD (26,5 mm)	-	-	0,310 kg/m
	1949	CAM ÇITASI (25,5 mm) GLAZING BEAD (25,5 mm)	-	-	0,306 kg/m
	5527	CAM ÇITASI (25,5 mm) GLAZING BEAD (25,5 mm)	-	-	0,293 kg/m
	1745	CAM ÇITASI (21,5 mm) GLAZING BEAD (21,5 mm)	-	-	0,292 kg/m
	1746	CAM ÇITASI (21,5 mm) GLAZING BEAD (21,5 mm)	-	-	0,279 kg/m
	5546	CAM ÇITASI (19,5 mm) GLAZING BEAD (19,5 mm)	-	-	0,271 kg/m
	3539	CAM ÇITASI (17 mm) GLAZING BEAD (17 mm)	-	-	0,277 kg/m
	1699	CAM ÇITASI (19,5 mm) GLAZING BEAD (19,5 mm)	-	-	0,285 kg/m
	1698	CAM ÇITASI (13,5 mm) GLAZING BEAD (13,5 mm)	-	-	0,253 kg/m

\*\* Her profil için minimum sipariş 300 kg'dır.  
\*\* Minimum order quantity is 300 kg per profile.

PROFİL KESİTİ PROFILE SECTION	PROFİL KODU PROFILE CODE	PROFİL ADI PROFILE NAME	Jx cm <sup>4</sup>	Jy cm <sup>4</sup>	AĞIRLIK (kg/m) WEIGHT
	1948	CAM ÇİTASI (7,5 mm) GLAZING BEAD (7,5 mm)	-	-	0,225 kg/m
	1912	PERVAZ PROFİLİ SILL PROFILE	-	-	0,211 kg/m
	1681	PERVAZ PROFİLİ SILL PROFILE	-	-	0,340 kg/m
	4251	PERVAZ PROFİLİ SILL PROFILE	-	-	0,182 kg/m
	553	PERVAZ PROFİLİ SILL PROFILE	-	-	0,656 kg/m
	10012	PERVAZ PROFİLİ SILL PROFILE	-	-	0,805 kg/m
	12371	DUVAR ADAPTÖR PROFİLİ WALL ADAPTER PROFILE	-	-	0,469 kg/m
	1661	KÖŞE TAKOZ PROFİLİ CORNER WEDGE PROFILE	-	-	3,629 kg/m
	1662	KÖŞE TAKOZ PROFİLİ CORNER WEDGE PROFILE	-	-	2,576 kg/m
	1663	KÖŞE TAKOZ PROFİLİ CORNER WEDGE PROFILE	-	-	3,526 kg/m
	1695	KÖŞE TAKOZ PROFİLİ CORNER WEDGE PROFILE	-	-	2,540 kg/m
	1696	KÖŞE TAKOZ PROFİLİ CORNER WEDGE PROFILE	-	-	3,340 kg/m
	1664	KÖŞE TAKOZ PROFİLİ CORNER WEDGE PROFILE	-	-	3,991 kg/m
	1697	KÖŞE TAKOZ PROFİLİ CORNER WEDGE PROFILE	-	-	4,212 kg/m
	1903	KÖŞE TAKOZ PROFİLİ CORNER WEDGE PROFILE	-	-	6,162 kg/m
	1398	KÖŞE TAKOZ PROFİLİ CORNER WEDGE PROFILE	-	-	5,085 kg/m
	3088	KÖŞE TAKOZ PROFİLİ CORNER WEDGE PROFILE	-	-	3,498 kg/m

\*\* Her profil için minimum sipariş 300 kg'dır.  
\*\* Minimum order quantity is 300 kg per profile.





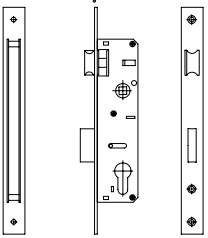
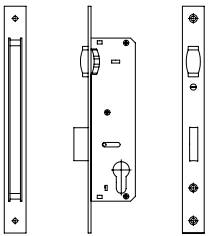
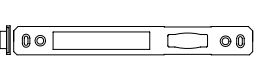
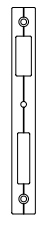
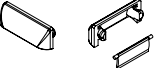



AKSESUAR ACCESSORY	STOK KODU REFERENCE CODE	AKSESUAR ADI DESCRIPTION	AKSESUAR KODU PRODUCT CODE	PAKET PACK
	AKS1275	KASA FİTİLİ FRAME GASKET	WD55-KBF.36	300 mt / paket 10 kg
	AKS1285	KASA FİTİLİ FRAME GASKET	WD55-KBF.46	275 mt / paket 10 kg
	AKS1287	KANAT FİTİLİ SASH GASKET	WD55-KBF.56	235 mt / paket 10 kg
	AKS1254	DIŞ CAM FİTİLİ OUTER GLAZING GASKET	WD55-DCF.30	215mt / paket 10 kg
	AKS1256	DIŞ CAM FİTİLİ OUTER GLAZING GASKET	WD55-DCF.45	130 mt / paket 10 kg
	AKS1338	İÇ CAM FİTİLİ INNER GLAZING GASKET	WD55-İCF.30	330 mt / paket 10 kg
	AKS1339	İÇ CAM FİTİLİ INNER GLAZING GASKET	WD55-İCF.40	205 mt / paket 10 kg
	AKS1341	İÇ CAM FİTİLİ INNER GLAZING GASKET	WD55-İCF.50	175 mt / paket 10 kg
	AKS1337	İÇ CAM FİTİLİ INNER GLAZING GASKET	WD55-İCF.23	210 mt / paket 10 kg
	AKS1340	İÇ CAM FİTİLİ INNER GLAZING GASKET	WD55-İCF.45	225 mt / paket 10 kg
	AKS1319	ORTA BİNİ FİTİLİ MIDDLE GASKET	WD55-OBF.06	105 mt / paket 10 kg
	AKS1538	FİRÇA FİTİLİ (6.8 - 7 mm) WEATHER STRIP (6.8 - 7 mm)	WD55-FÇ.710	300 mt / paket 10 kg
	AKS707	SİSTEM WD55 ADAPTÖR KAPAĞI SYSTEM WD55 ADAPTER COVER	WD55-ADK.240	100 ad / 1 pk
	AKS789	KÖŞE GÖNYE CORNER BRACKET	WD55-KG.318	1000 ad / 1 pk
	AKS785	KÖŞE ÇAVUŞU CORNER CONNECTION	WD55-FJ.314	250 ad / 1 pk
	AKS743	AYARLI İSPANYOLET KARŞILIĞI (SETSKURLU) ADJUSTABLE ESPAGNOLETTE STRIKER (PINNED)	WD55-TPK.201	100 ad / 1 pk
	AKS739	İSPANYOLET PİMİ (EURO KANAL) ESPAGNOLETTE PIN (EURO GROOVE)	WD55-TP.100	100 ad / 1 pk
	AKS1912	CAM TAKOZU (3X20X80 mm) GLAZING WEDGE (3X20X80 mm)	WD55-CT.203	1000 ad / 1 pk
	AKS1915	CAM TAKOZU (5X20X80 mm) GLAZING WEDGE (5X20X80 mm)	WD55-CT.208	1000 ad / 1 pk
	AKS1916	CAM TAKOZU (5X28X80 mm) GLAZING WEDGE (5X28X80 mm)	WD55-CT.210	1000 ad / 1 pk

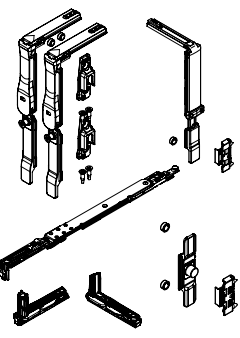
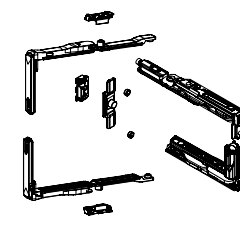
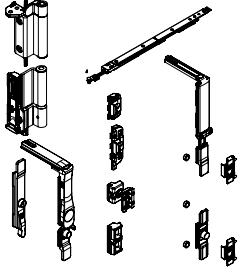
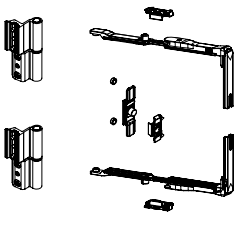
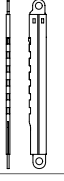
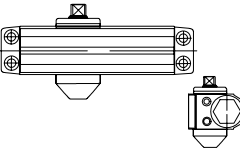

AKSESUAR ACCESSORY	STOK KODU REFERENCE CODE	AKSESUAR ADI DESCRIPTION	AKSESUAR KODU PRODUCT CODE	PAKET PACK
	AKS1667	153/35 mm DİLLİ KİLİT BOLT LOCK	WD55-DK.401	30 ad / 1 pk
	AKS1671	155/35 mm MAKARALI KİLİT ROLLED LOCK	WD55-MK.405	30 ad / 1 pk
	AKS1740	81 mm BAREL 81 mm CYLINDER	WD55-BR.131	24 ad / 1 pk
	AKS4742	OVAL SERİ KİLİT KARŞILIĞI (DİLLİ) OVAL SERIES LOCK STRIKER (BOLT)	WD55-KK.210	50 ad / 1 pk
	AKS421	OVAL SERİ KİLİT KARŞILIĞI (MAKARALI) OVAL SERIES LOCK STRIKER (ROLLED)	WD55-KK.211	50 ad / 1 pk
	AKS423	SİSTEM KİLİT KARŞILIĞI DİLLİ (ELOKSALLI) SYSTEM BOLT LOCK STRIKER (ANODIZED)	WD55-DK.301	50 ad / 1 pk
	AKS424	SİSTEM KİLİT KARŞILIĞI DİLLİ (BEYAZ) SYSTEM BOLT LOCK STRIKER (WHITE)	WD55-DK.302	50 ad / 1 pk
	AKS425	SİSTEM KİLİT KARŞILIĞI DİLLİ (RENKLİ) SYSTEM BOLT LOCK STRIKER (COLORED)	WD55-DK.303	50 ad / 1 pk
	AKS427	SİSTEM KİLİT KARŞILIĞI MAKARALI (ELOKSALLI) SYSTEM ROLLED LOCK STRIKER (ANODIZED)	WD55-MK.310	50 ad / 1 pk
	AKS428	SİSTEM KİLİT KARŞILIĞI MAKARALI (BEYAZ) SYSTEM ROLLED LOCK STRIKER (WHITE)	WD55-MK.311	50 ad / 1 pk
	AKS429	SİSTEM KİLİT KARŞILIĞI DİLLİ (RENKLİ) SYSTEM ROLLED LOCK STRIKER (COLORED)	WD55-MK.312	50 ad / 1 pk
	AKS1557	SABİT PERDELİ YAĞMUR TAHLİYE KAPAK WATER DRAIN COVER (FIXED)	WD55-TK.115	1000 ad / 1 pk
	AKS1556	HAREKETLİ PERDELİ YAĞMUR TAHLİYE KAPAK WATER DRAIN COVER (MOVEABLE)	WD55-TK.112	1000 ad / 1 pk
	AKS824	ALÜMİNYUM KAPI ALTI FIRÇASI ALUMINIUM DOORBASE BRUSH	WD55-KF.200	100 ad / 1 pk
	AKS39	WD55 PİVOT MENTEŞE (ELOKSAL) WD55 PIVOT HINGE (ANODIZED)	WD55-PM.1001	1 ad / 1 pk
	AKS40	WD55 PİVOT MENTEŞE (BEYAZ) WD55 PIVOT HINGE (WHITE)	WD55-PM.1002	1 ad / 1 pk
	AKS41	WD55 PİVOT MENTEŞE (RENKLİ) WD55 PIVOT HINGE (COLORED)	WD55-PM.1003	1 ad / 1 pk

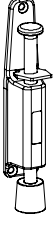
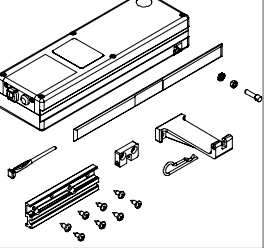
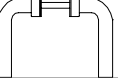
AKSESUAR ACCESSORY	STOK KODU REFERENCE CODE	AKSESUAR ADI DESCRIPTION	AKSESUAR KODU PRODUCT CODE	PAKET PACK
	AKS30	SİSTEM PENCERE MENTEŞE (ELOKSALLI) SYSTEM WINDOW HINGE (ANODIZED)	WD55-PM.901	10 ad / 1 pk
	AKS31	SİSTEM PENCERE MENTEŞE (BEYAZ) SYSTEM WINDOW HINGE (WHITE)	WD55-PM.902	10 ad / 1 pk
	AKS32	SİSTEM PENCERE MENTEŞE (RENKLİ) SYSTEM WINDOW HINGE (COLORED)	WD55-PM.903	10 ad / 1 pk
	AKS59	SİSTEM PENCERE VE KAPI MENTEŞE (ELOKSALLI) SYSTEM WINDOW AND DOOR HINGE (ANODIZED)	WD55-PKM.101	10 ad / 1 pk
	AKS60	SİSTEM PENCERE VE KAPI MENTEŞE (BEYAZ) SYSTEM WINDOW AND DOOR HINGE (WHITE)	WD55-PKM.102	10 ad / 1 pk
	AKS61	SİSTEM PENCERE VE KAPI MENTEŞE (RENKLİ) SYSTEM WINDOW AND DOOR HINGE (COLORED)	WD55-PKM.103	10 ad / 1 pk
	AKS64	SİSTEM KAPI MENTEŞE (ELOKSALLI) SYSTEM DOOR HINGE (ANODIZED)	WD55-KM.111	10 ad / 1 pk
	AKS65	SİSTEM KAPI MENTEŞE (BEYAZ) SYSTEM DOOR HINGE (WHITE)	WD55-KM.112	10 ad / 1 pk
	AKS66	SİSTEM KAPI MENTEŞE (RENKLİ) SYSTEM DOOR HINGE (COLORED)	WD55-KM.113	10 ad / 1 pk
	AKS47	İÇE VE DIŞA AÇILIR BİNİLİ KAPI MENTEŞE (ELOKSALLI) INWARD AND OUTWARD OPENING HINGE (ANODIZED)	WD55-KM.050	1 ad / 1 pk
	AKS48	İÇE VE DIŞA AÇILIR BİNİLİ KAPI MENTEŞE (BEYAZ) INWARD AND OUTWARD OPENING HINGE (WHITE)	WD55-KM.051	1 ad / 1 pk
	AKS49	İÇE VE DIŞA AÇILIR BİNİLİ KAPI MENTEŞE (RENKLİ) INWARD AND OUTWARD OPENING HINGE (COLORED)	WD55-KM.052	1 ad / 1 pk
	AKS56	DIŞA AÇILIR ADAPTÖRLÜ BİNİLİ KAPI MENTEŞE (ELOKSALLI) OUTWARD OPENING OVERLAPPING HINGE (ANODIZED)	WD55-KM.065	1 ad / 1 pk
	AKS57	DIŞA AÇILIR ADAPTÖRLÜ BİNİLİ KAPI MENTEŞE (BEYAZ) OUTWARD OPENING OVERLAPPING HINGE (WHITE)	WD55-KM.066	1 ad / 1 pk
	AKS58	DIŞA AÇILIR ADAPTÖRLÜ BİNİLİ KAPI MENTEŞE (RENKLİ) OUTWARD OPENING OVERLAPPING HINGE (COLORED)	WD55-KM.067	1 ad / 1 pk
	AKS84	İÇE VE DIŞA AÇILIR BİNİLİ KAPI MENTEŞE (ELOKSALLI) INWARD AND OUTWARD OPENING HINGE (ANODIZED)	WD55-KM.820	1 ad / 1 pk
	AKS85	İÇE VE DIŞA AÇILIR BİNİLİ KAPI MENTEŞE (BEYAZ) INWARD AND OUTWARD OPENING HINGE (WHITE)	WD55-KM.821	1 ad / 1 pk
	AKS86	İÇE VE DIŞA AÇILIR BİNİLİ KAPI MENTEŞE (RENKLİ) INWARD AND OUTWARD OPENING HINGE (COLORED)	WD55-KM.822	1 ad / 1 pk
	AKS93	DIŞA AÇILIR ADAPTÖRLÜ BİNİLİ KAPI MENTEŞE (ELOKSALLI) OUTWARD OPENING OVERLAPPING HINGE (ANODIZED)	WD55-KM.835	1 ad / 1 pk
	AKS94	DIŞA AÇILIR ADAPTÖRLÜ BİNİLİ KAPI MENTEŞE (BEYAZ) OUTWARD OPENING OVERLAPPING HINGE (WHITE)	WD55-KM.836	1 ad / 1 pk
	AKS95	DIŞA AÇILIR ADAPTÖRLÜ BİNİLİ KAPI MENTEŞE (RENKLİ) OUTWARD OPENING OVERLAPPING HINGE (COLORED)	WD55-KM.837	1 ad / 1 pk

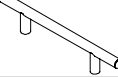
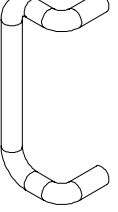
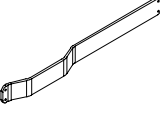
AKSESUAR ACCESSORY	STOK KODU REFERENCE CODE	AKSESUAR ADI DESCRIPTION	AKSESUAR KODU PRODUCT CODE	PAKET PACK
	AKS100	ÇARPMA KAPI MENTEŞE (ELOKSALLI) OUTWARD OPENING OVERLAPPING HINGE (ANODIZED)	WD55-ÇM.206	2 ad / 1 pk
	AKS99	ÇARPMA KAPI MENTEŞE (BEYAZ) OUTWARD OPENING OVERLAPPING HINGE (WHITE)	WD55-ÇM.202	2 ad / 1 pk
	AKS437	SİSTEM UZUN ZAMAK SÜRGÜ (NATUREL) SYSTEM ZAMAK LATCH (NATURAL)	WD55-FS.201	10 ad / 1 pk
	AKS438	SİSTEM UZUN ZAMAK SÜRGÜ (BEYAZ) SYSTEM ZAMAK LATCH (WHITE)	WD55-FS.202	10 ad / 1 pk
	AKS439	SİSTEM UZUN ZAMAK SÜRGÜ (RENKLİ) SYSTEM ZAMAK LATCH (COLORED)	WD55-FS.203	10 ad / 1 pk
	AKS489	SİSTEM 13 CM VASİSTAS MAKAS (NATUREL) SYSTEM 13 CM TRANSOM TRUSS (ANODIZED)	WD55-VM.301	50 ad / 1 pk
	AKS490	SİSTEM 13 CM VASİSTAS MAKAS (BEYAZ) SYSTEM 13 CM TRANSOM TRUSS (WHITE)	WD55-VM.302	50 ad / 1 pk
	AKS491	SİSTEM 13 CM VASİSTAS MAKAS (RENKLİ) SYSTEM 13 CM TRANSOM TRUSS (COLORED)	WD55-VM.303	50 ad / 1 pk
	AKS493	SİSTEM 22 CM VASİSTAS MAKAS (NATUREL) SYSTEM 22 CM TRANSOM TRUSS (ANODIZED)	WD55-VM.401	50 ad / 1 pk
	AKS494	SİSTEM 22 CM VASİSTAS MAKAS (BEYAZ) SYSTEM 22 CM TRANSOM TRUSS (WHITE)	WD55-VM.402	50 ad / 1 pk
	AKS495	SİSTEM 22 CM VASİSTAS MAKAS (RENKLİ) SYSTEM 22 CM TRANSOM TRUSS (COLORED)	WD55-VM.403	50 ad / 1 pk
	AKS540	PVC KANALLI TEK AÇILIM MENTEŞE TAKIMI (9/18) PVC GROOVED CASEMENT HINGE SET (9/18)	WD55-PM.650	10 ad / 1 pk
	AKS3930	PVC KANALLI ÇİFT AÇILIM MENTEŞE TAKIMI TİP 1 (9/18) PVC GROOVED TILT&TURN HINGE SET TYPE 1 (9/18)	WD55-PMT.420	1 ad / 1 pk
	AKS69	AYARLI KAPI MENTEŞESİ ADJUSTABLE DOOR HINGE	WD55-AKM.120	2 ad / 1 pk
	AKS70	AYARLI KAPI MENTEŞESİ ADJUSTABLE DOOR HINGE	WD55-AKM.121	2 ad / 1 pk
	AKS71	AYARLI KAPI MENTEŞESİ ADJUSTABLE DOOR HINGE	WD55-AKM.122	2 ad / 1 pk

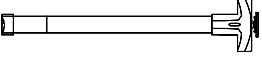
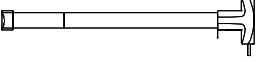
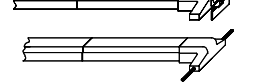
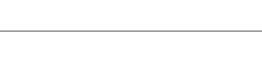

AKSESUAR ACCESSORY	STOK KODU REFERENCE CODE	AKSESUAR ADI DESCRIPTION	AKSESUAR KODU PRODUCT CODE		PAKET PACK
	AKS3972	GİZLİ MENTEŞELİ ÇİFT AÇILIM SETİ TİP 1 (SAĞ-SOL) HIDDEN HINGE TILT-TURN SET TYPE 1 (RIGHT-LEFT)	WD55-GM.470	TAŞIMA KAPASİTESİ 100 KG LOADING CAPACITY 100 KG	1 ad / 1 pk
	AKS763	GİZLİ MENTEŞELİ TEK AÇILIM SETİ (SAĞ-SOL) HIDDEN HINGE CASEMENT SET (RIGHT-LEFT)	WD55-GM.350	TAŞIMA KAPASİTESİ 100 KG LOADING CAPACITY 100 KG	1 ad / 1 tk
	AKS3978	EURO KANALLI ÇİFT AÇILIM SETİ TİP 1 EURO GROOVED TILT-TURN SET TYPE 1	WD55-CS.410	TAŞIMA KAPASİTESİ MENTEŞE KİTİ DEĞİŞTİRİLEREK 90 İLE 160 KG ARALIĞINDA TERCİH EDİLEBİLİR. Depending on the hinge selection loading capacity can be between 90-160 kg.	1 ad / 1 pk
	AKS766	TEK AÇILIM SETİ CASEMENT SET	WD55-TS.353	TAŞIMA KAPASİTESİ MENTEŞE KİTİ DEĞİŞTİRİLEREK 65 İLE 160 KG ARALIĞINDA TERCİH EDİLEBİLİR. Depending on the hinge selection loading capacity can be between 65-160 kg.	1 ad / 1 pk
	AKS499	AYARLI KADEMELİ MAKAS 5 KADEME ADJUSTABLE TRUSS 5 LEVEL	WD55-KM.1000		1 ad / 1 pk
	AKS500	AYARLI KADEMELİ MAKAS 3 KADEME ADJUSTABLE TRUSS 3 LEVEL	WD55-KM.1001		1 ad / 1 pk
	AKS2593	KAPI POMPASI DOOR PUMP	WD55-KP.306		1 ad / 1 tk
	AKS4212	40'LİK KÖR KASA YALITIM BANDI BLIND FRAME INSULATING TAPE (40)	WD55-KTB.100		50 mt / 1 top
	AKS4213	60'LİK KÖR KASA YALITIM BANDI BLIND FRAME INSULATING TAPE (60)	WD55-KTB.110		50 mt / 1 top

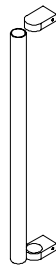
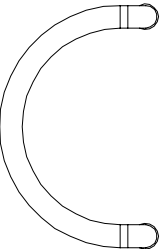
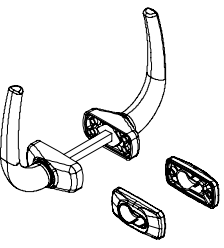
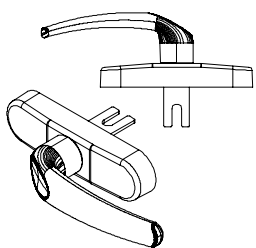
AKSESUAR ACCESSORY	STOK KODU REFERENCE CODE	AKSESUAR ADI DESCRIPTION	AKSESUAR KODU PRODUCT CODE	PAKET PACK
	AKS2611	KAPI STOPERİ (BEYAZ) DOOR STOPER (WHITE)	WD55-KP.521	1 ad / 1 pk
	AKS2612	KAPI STOPERİ (RENKLİ) DOOR STOPER (COLORED)	WD55-KP.522	1 ad / 1 pk
	AKS2613	KAPI STOPERİ (NATUREL) DOOR STOPER (NATURAL)	WD55-KP.523	1 ad / 1 pk
	AKS2616	MOTORLU YÜKSEK AÇILIM SETİ MOTORIZED HIGH OPENING SET	WD55-MYAS.20	1 ad / 1 pk
	AKS4315	YAYLI SOSİS KOL SPRING DOOR HANDLE	WD55-YK.104	1 ad / 1 pk
	AKS4750	YAYLI SOSİS KOL BAREL ROZETİ SPRING DOOR HANDLE CYLINDER BADGE	WD55-BR.109	2 ad / 1 pk
	AKS401	U KOL (ELOKSALLI) U SHAPED HANDLE (ANODIZED)	WD55-UK.101	1 ad / 1 pk
	AKS219	H KOL (ELOKSALLI) H SHAPED HANDLE (ANODIZED)	WD55-HK.309	1 ad / 1 pk
	AKS159	KIVRIK KOL (ELOKSALLI) CONVOLUTED HANDLE (ANODIZED)	WD55-VK.401	1 ad / 1 pk
	AKS153	25 mm 20 cm KIVRIK KOL (PRES) CONVOLUTED HANDLE (PRESS)	WD55-KKP.300	1 ad / 1 pk
	AKS158	25 mm 30 cm KIVRIK KOL (PRES) CONVOLUTED HANDLE (PRESS)	WD55-KKP.400	1 ad / 1 pk
	AKS3987	90 CM PLEKSİ BANT KOL 90 CM PLEXY TAPE HANDLE	WD55-LBK.210	1 tk / 1 pk
	AKS3988	100 CM PLEKSİ BANT KOL 100 CM PLEXY TAPE HANDLE	WD55-LBK.211	1 tk / 1 pk
	AKS196	50 CM YAY KOL (PRES) 50 CM SPRING HANDLE (PRESS)	WD55-YK.199	1 ad / 1 pk
	AKS197	50 CM YAY KOL (BEYAZ) 50 CM SPRING HANDLE (WHITE)	WD55-YK.200	1 ad / 1 pk
	AKS198	50 CM YAY KOL (ELOKSALLI) 50 CM SPRING HANDLE (ANODIZED)	WD55-YK.201	1 ad / 1 pk
	AKS199	50 CM YAY KOL (RENKLİ) 50 CM SPRING HANDLE (COLORED)	WD55-YK.202	1 ad / 1 pk
	AKS892	ROTO SECUSTİK PENCERE KOLU ROTO SECUSTIK WINDOW HANDLE	WD55-RK.291	1 ad / 1 pk

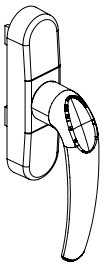
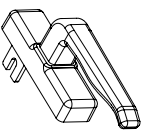
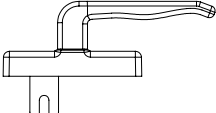
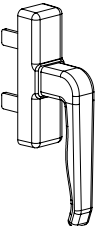
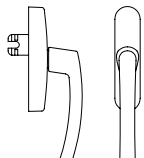
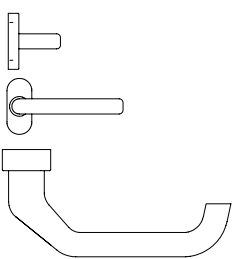
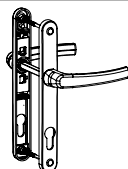
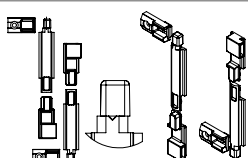
AKSESUAR ACCESSORY	STOK KODU REFERENCE CODE	AKSESUAR ADI DESCRIPTION	AKSESUAR KODU PRODUCT CODE	PAKET PACK
	AKS828	PANİK BAR BARELSİZ PANIC BAR	WD55-PB.103	1 ad / 1 kutu
	AKS830	PANİK BAR ROZETLİ KOL (KİLİTLENEBİLİR) PANIC BAR BADGE HANDLE (LOCKABLE)	WD55-PB.104	1 ad / 1 kutu
	AKS829	PANİK BAR BARELLİ PANIC BAR WITH BARREL	WD55-PB.105	75 ad / 1 kutu
	AKS1943	PANİK BAR-ÇİFT KANAT SERT BARELSİZ PANIC BAR	WD55-PB.106	4 ad / 1 kutu
	AKS185	AKBANK KOLU APARATI BORU HARIÇ (PRES) AKBANK DOOR HANDLE KIT WITHOUT PIPE (PRESS)	WD55-AK.100	1 ad / 1 pk
	AKS186	AKBANK KOLU APARATI BORU HARIÇ (ELOKSALLI) AKBANK DOOR HANDLE KIT WITHOUT PIPE(ANODIZED)	WD55-AK.101	1 ad / 1 pk
	AKS187	AKBANK KOLU APARATI BORU HARIÇ (BEYAZ) AKBANK DOOR HANDLE KIT WITHOUT PIPE (WHITE)	WD55-AK.102	1 ad / 1 pk
	AKS188	AKBANK KOLU APARATI BORU HARIÇ (RENKLİ) AKBANK DOOR HANDLE KIT WITHOUT PIPE (COLORED)	WD55-AK.103	1 ad / 1 pk
	AKS190	AKBANK KOLU DÜZ APARATI BORU HARIÇ (PRES) STRAIGHT AKBANK DOOR HANDLE (PRESS)	WD55T-AK.190	1 ad / 1 pk
	AKS174	YARIM AY KAPI KOLU (ELOKSALLI) SEMI-CIRCULAR DOOR HANDLE (ANODIZED)	WD55-YAK.901	
	AKS175	YARIM AY KAPI KOLU (B. BOYALI) SEMI-CIRCULAR DOOR HANDLE (PAINTED)	WD55-YAK.902	1 ad / 1 pk
	AKS176	YARIM AY KAPI KOLU (RENKLİ) SEMI-CIRCULAR DOOR HANDLE (COLORED)	WD55-YAK.903	1 ad / 1 pk
	AKS307	FORZA EFOR YAYLI KAPI KOLU (BEYAZ) FORZA EFOR SPRING DOOR HANDLE (WHITE)	WD55-FK.902	1 ad / 1 pk
	AKS308	FORZA EFOR YAYLI KAPI KOLU (RENKLİ) FORZA EFOR SPRING DOOR HANDLE (COLORED)	WD55-FK.903	1 ad / 1 pk
	AKS309	FORZA EFOR YAYLI KAPI KOLU (NATUREL) FORZA EFOR SPRING DOOR HANDLE (NATURAL)	WD55-FK.904	1 ad / 1 pk
	AKS122	FORZA EFOR EKSENEL PENCERE KOLU (BEYAZ) FORZA EFOR AXIAL WINDOW HANDLE (WHITE)	WD55-FPK.702	1 ad / 1 pk
	AKS123	FORZA EFOR EKSENEL PENCERE KOLU (RENKLİ) FORZA EFOR AXIAL WINDOW HANDLE (COLORED)	WD55-FPK.703	1 ad / 1 pk
	AKS124	FORZA EFOR EKSENEL PENCERE KOLU (NATUREL) FORZA EFOR AXIAL WINDOW HANDLE (NATURAL)	WD55-FPK.803	1 ad / 1 pk

AKSESUAR ACCESSORY	STOK KODU REFERENCE CODE	AKSESUAR ADI DESCRIPTION	AKSESUAR KODU PRODUCT CODE	PAKET PACK
	AKS3914	FORZA EFOR EKSENEL PENCERE KOLU ÇİFT DİLLİ (PRES) FORZA EFOR AXIAL WINDOW HANDLE DOUBLE LATCH (PRESS)	WD55-PK.708	1 ad / 1 pk
	AKS3915	FORZA EFOR EKSENEL PENCERE KOLU ÇİFT DİLLİ (BEYAZ) FORZA EFOR AXIAL WINDOW HANDLE DOUBLE LATCH (WHITE)	WD55-PK.709	1 ad / 1 pk
	AKS3916	FORZA EFOR EKSENEL PENCERE KOLU ÇİFT DİLLİ (NATUREL) FORZA EFOR AXIAL WINDOW HANDLE DOUBLE LATCH (NATURAL)	WD55-PK.710	1 ad / 1 pk
	AKS3917	FORZA EFOR EKSENEL PENCERE KOLU ÇİFT DİLLİ (RENKLİ) FORZA EFOR AXIAL WINDOW HANDLE DOUBLE LATCH (COLORED)	WD55-PK.711	1 ad / 1 pk
 	AKS125	FORZA YANKI EKSENEL PENCERE KOLU (PRES) FORZA YANKI AXIAL WINDOW HANDLE (PRESS)	WD55-EK.809	1 ad / 1 pk
	AKS126	FORZA YANKI EKSENEL PENCERE KOLU (NATUREL) FORZA YANKI AXIAL WINDOW HANDLE (NATURAL)	WD55-EK.810	1 ad / 1 pk
	AKS127	FORZA YANKI EKSENEL PENCERE KOLU (BEYAZ) FORZA YANKI AXIAL WINDOW HANDLE (WHITE)	WD55-EK.811	1 ad / 1 pk
	AKS128	FORZA YANKI EKSENEL PENCERE KOLU (RENKLİ) FORZA YANKI AXIAL WINDOW HANDLE (COLORED)	WD55-EK.812	1 ad / 1 pk
	AKS3918	FORZA YANKI EKSENEL PENCERE KOLU ÇİFT DİLLİ(NATUREL) FORZA YANKI AXIAL WINDOW HANDLE DOUBLE LATCH (NATURAL)	WD55-FYK.820	1 ad / 1 pk
	AKS3919	FORZA YANKI EKSENEL PENCERE KOLU ÇİFT DİLLİ(BEYAZ) FORZA YANKI AXIAL WINDOW HANDLE DOUBLE LATCH (WHITE)	WD55-FYK.821	1 ad / 1 pk
	AKS3920	FORZA YANKI EKSENEL PENCERE KOLU ÇİFT DİLLİ(RENKLİ) FORZA YANKI AXIAL WINDOW HANDLE DOUBLE LATCH (COLORED)	WD55-FYK.822	1 ad / 1 pk
	AKS3921	FORZA YANKI EKSENEL PENCERE KOLU ÇİFT DİLLİ(PRES) FORZA YANKI AXIAL WINDOW HANDLE DOUBLE LATCH (PRESS)	WD55-FYK.823	1 ad / 1 pk
	AKS120	EKSENEL KOL ROTO (ELOKSALLI) ROTO AXIAL HANDLE (ANODIZED)	WD55-RK.601	1 ad / 1 pk
	AKS121	EKSENEL KOL ROTO (ELOKSALLI KİLİTLİ) ROTO AXIAL HANDLE (ANODIZED LOCKED)	WD55-RK.604	1 ad / 1 pk
	AKS4152	PASLANMAZ KAPI KOLU STAINLESS DOOR HANDLE	WD55-GK.910	1 ad / 1 pk
	AKS4150	AYNALI KAPI KOLU MIRROR DOOR HANDLE	WD55-AKK.830	1 ad / 1 pk
	AKS768	ÇİFT MAÇALI KOL TİJ BAĞLANTI DOUBLE CORE HANDLE STEM BAR CONNECTION	WD55-MTB.600	1 tk / 1 pk

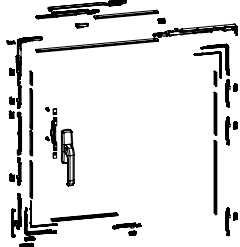
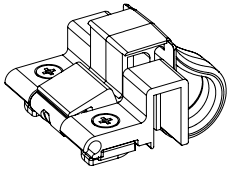
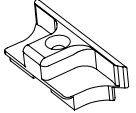
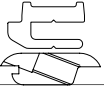
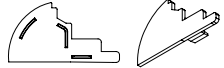
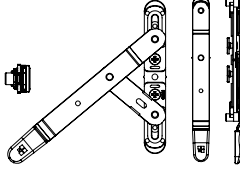
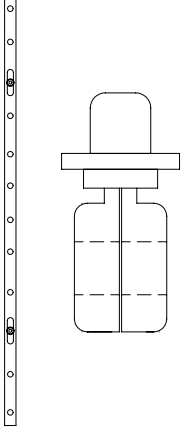

AKSESUAR ACCESSORY	STOK KODU REFERENCE CODE	AKSESUAR ADI DESCRIPTION	AKSESUAR KODU PRODUCT CODE	PAKET PACK
	AKS3926	TEK MAÇALI KOL TİJ BAĞLANTI SINGLE CORE HANDLE STEM BAR CONNECTION	WD55-MTB.610	1 ad / 1 tk
	AKS3989	TBT AÇILIM SETİ TBT OPENING SET	WD55-TBT.871	1 ad / 1 tk
	AKS507	SİSTEM AYARLI VASİSTAS ÇARPMA (NATUREL) SYSTEM TRANSOM CATCH (NATURAL)	WD55-VÇ.702	1 ad / 1 pk
	AKS508	SİSTEM AYARLI VASİSTAS ÇARPMA (BEYAZ) SYSTEM TRANSOM CATCH (WHITE)	WD55-VÇ.703	1 ad / 1 pk
	AKS509	SİSTEM AYARLI VASİSTAS ÇARPMA (RENKLİ) SYSTEM TRANSOM CATCH (COLORED)	WD55-VÇ.704	1 ad / 1 pk
	AKS752	PVC KANALLI İSPANYOLET KARŞILIĞI PVC GROOVED ESPAGNOLETTE STRIKER (SCREWED)	WD55-PK.217	100 ad / 1 pk
	AKS3927	SİSTEM KANAT KALDIRMA TAKOZU SYSTEM SASH ADJUSTING BRACKET	WD55-KST.210	50 ad / 1 pk
	AKS737	DAMLALIK KAPAK SILL COVER	WD55-DK.50	1 tk / 1 pk
	AKS3929	LEVYE KOL (EURO KANAL İÇİN) SHOOTBOLT KIT LOCKING (FOR EURO GROOVE)	WD55-LK.201	1 ad / 1 pk
	AKS1812	İSPANYOLET-80 cm ESPAGNOLETTE-80 cm	WD55-İSP.452	1 ad / 1 pk
	AKS1813	İSPANYOLET-100 cm ESPAGNOLETTE-100 cm	WD55-İSP.453	1 ad / 1 pk
	AKS1814	İSPANYOLET-120 cm ESPAGNOLETTE-120 cm	WD55-İSP.454	1 ad / 1 pk
	AKS1815	İSPANYOLET-140 cm ESPAGNOLETTE-140 cm	WD55-İSP.455	1 ad / 1 pk
	AKS1816	İSPANYOLET-160 cm ESPAGNOLETTE-160 cm	WD55-İSP.456	1 ad / 1 pk
	AKS1817	İSPANYOLET-180 cm ESPAGNOLETTE-180 cm	WD55-İSP.457	1 ad / 1 pk
	AKS2256	Ø3.9X13 mm YSB M.U.V Ø3.9X13 mm SELF DRILLING CURVED TOP SCREW	WD55-SC.200	1000 ad / 1 pk

**PVC KANALLI ÇİFT AÇILIM**  
PVC GROOVED TILT-TURN

YÜKSEKLİK	GENİŞLİK						
	H \ L	400 - 500	501 - 750	751 - 1000	1001 - 1200	1201 - 1450	1451 - 1600
480 590		TİP 1 01 090420	TİP 2 01 090421	TİP 3 01 090422	TİP 4 01 090423	TİP 5 01 090424	TİP 6 01 090425
591 750		TİP 7 01 090426	TİP 8 01 090427	TİP 9 01 090428	TİP 10 01 090429	TİP 11 01 090430	TİP 12 01 090431
751 1200		TİP 13 01 090432	TİP 14 01 090433	TİP 15 01 090434	TİP 16 01 090435	TİP 17 01 090436	TİP 18 01 090437
951 1450		TİP 19 01 090438	TİP 20 01 090439	TİP 21 01 090440	TİP 22 01 090441	TİP 23 01 090442	TİP 24 01 090443
1201 1700		TİP 25 01 090444	TİP 26 01 090445	TİP 27 01 090446	TİP 28 01 090447	TİP 29 01 090448	TİP 30 01 090449
1201 1700		TİP 31 01 090450	TİP 32 01 090451	TİP 33 01 090452	TİP 34 01 090453	TİP 35 01 090454	TİP 36 01 090455
1201 1700		TİP 37 01 090456	TİP 38 01 090457	TİP 39 01 090458	TİP 40 01 090459	TİP 41 01 090460	TİP 42 01 090461

**EURO KANALLI ÇİFT AÇILIM**  
EURO GROOVED TILT-TURN

YÜKSEKLİK	GENİŞLİK			
	H \ L	390 - 700	701 -1300	1251 - 1600
580 1200		TİP 1 01 090410	TİP 2 01 090411	TİP 3 01 090412
1201 1800		TİP 4 01 090413	TİP 5 01 090414	TİP 6 01 090415
1801 2400		TİP 7 01 090416	TİP 8 01 090417	TİP 9 01 090418

**GİZLİ MENTEŞELİ ÇİFT AÇILIM SETİ**  
CASEMENT SET WITH CONCEALED HINGE TILT-TURN

YÜKSEKLİK	GENİŞLİK			
	H \ L	345 - 700	701 -1200	1200 - 1600
580 1200		TİP 1 01 090470	TİP 2 01 090471	TİP 3 01 090472
1801 2400		TİP 4 01 090473	TİP 5 01 090474	TİP 6 01 090475

**TBT AÇILIM**  
TBT OPENING

YÜKSEKLİK	GENİŞLİK				
	H \ L	430 - 700	701 -1200	1201 - 1350	1351 - 1600
500 1200		TİP 1 01 090871	TİP 2 01 090872	TİP 3 01 090873	TİP 4 01 090874
1201 2400		TİP 5 01 090875	TİP 6 01 090876	TİP 7 01 090877	TİP 8 01 090878

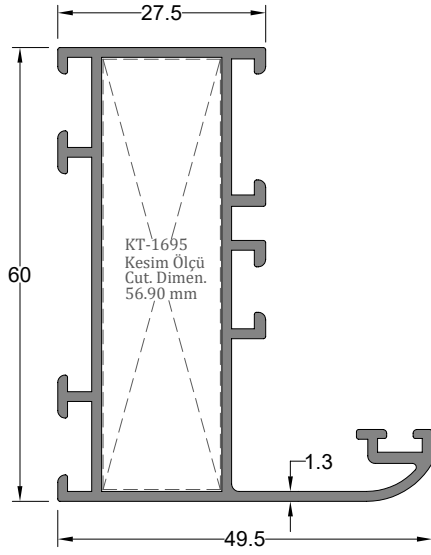

Kasa Profili	Profil Kodu	(kg/mt)	Jx cm <sup>4</sup>	Jy cm <sup>4</sup>
FRAME PROFILE	Profile Code	weight		
	1685	0,902	15,98	5,15

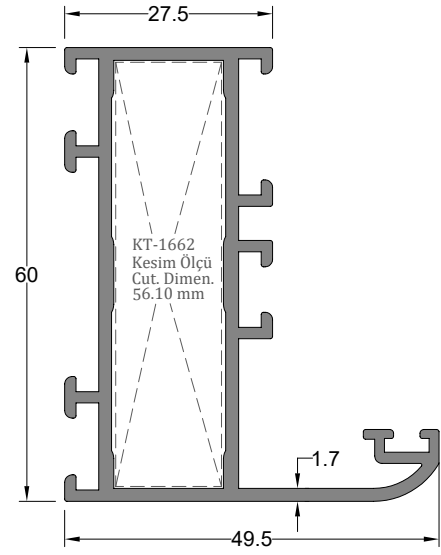

Kasa Profili	Profil Kodu	(kg/mt)	Jx cm <sup>4</sup>	Jy cm <sup>4</sup>
FRAME PROFILE	Profile Code	weight		
	1780	1,135	19,64	6,03

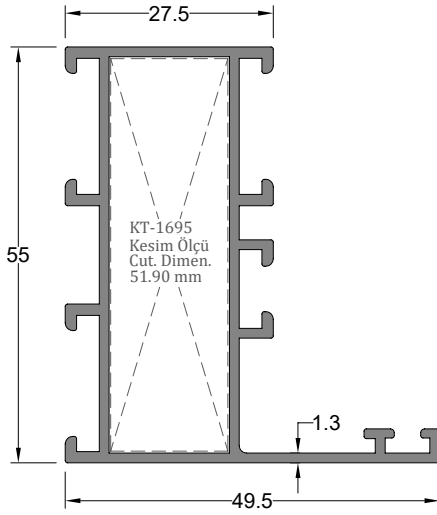

Kasa Profili	Profil Kodu	(kg/mt)	Jx cm <sup>4</sup>	Jy cm <sup>4</sup>
FRAME PROFILE	Profile Code	weight		
	1905	0,831	12,50	4,22

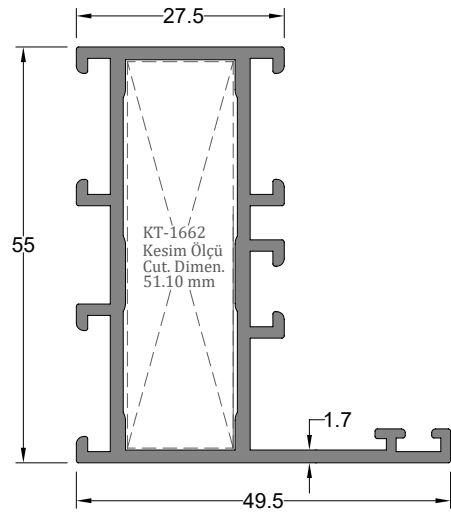

Kasa Profili	Profil Kodu	(kg/mt)	Jx cm <sup>4</sup>	Jy cm <sup>4</sup>
FRAME PROFILE	Profile Code	weight		
	1906	1,033	15,13	4,86

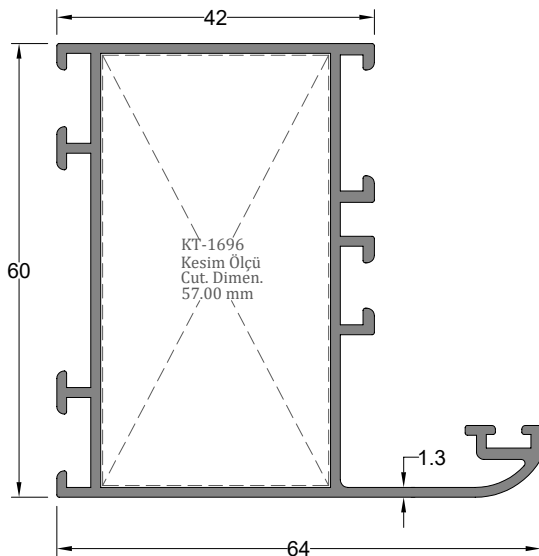

Kasa Profili	Profil Kodu	(kg/mt)	Jx cm <sup>4</sup>	Jy cm <sup>4</sup>
FRAME PROFILE	Profile Code	weight		
	1686	1,005	20,52	11,23

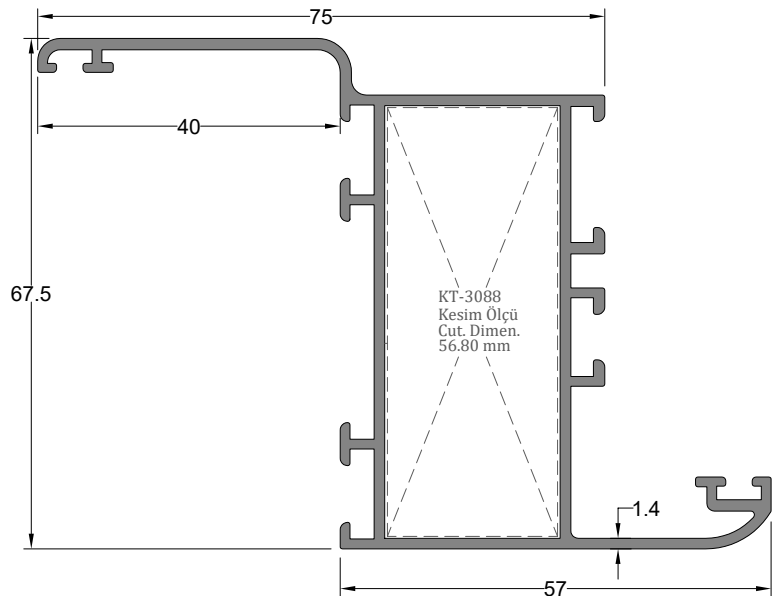

Kasa Profili	Profil Kodu	(kg/mt)	Jx cm <sup>4</sup>	Jy cm <sup>4</sup>
FRAME PROFILE	Profile Code	weight		
	12229	1,228	27,93	22,96

\*\* Her profil için minimum sipariş 300 kg'dır.  
\*\* Minimum order quantity is 300 kg per profile.

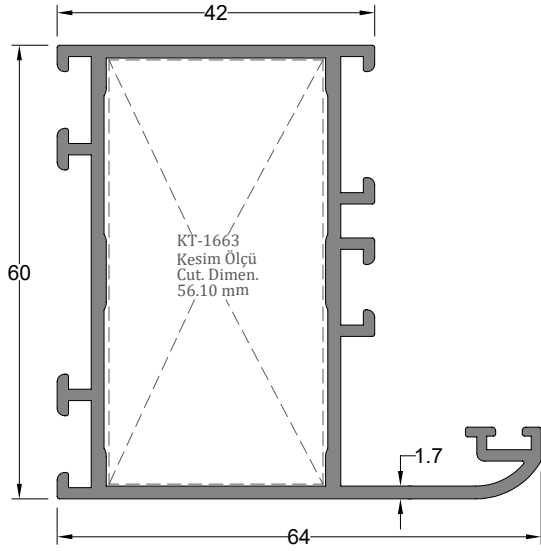

Kasa Profili FRAME PROFILE	Profil Kodu Profile Code	(kg/mt) weight	Jx cm <sup>4</sup>	Jy cm <sup>4</sup>
	1781	1,269	25,23	13,58

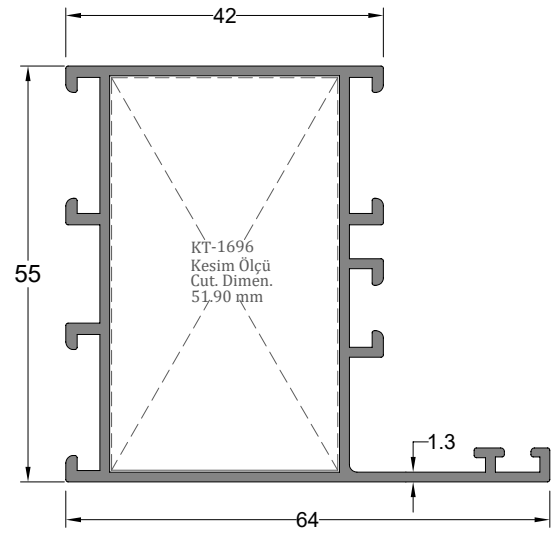

Kasa Profili FRAME PROFILE	Profil Kodu Profile Code	(kg/mt) weight	Jx cm <sup>4</sup>	Jy cm <sup>4</sup>
	1907	0,934	16,39	9,57

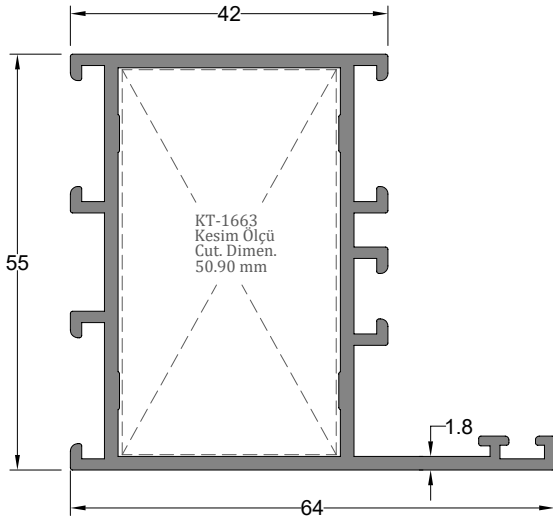

Kasa Profili FRAME PROFILE	Profil Kodu Profile Code	(kg/mt) weight	Jx cm <sup>4</sup>	Jy cm <sup>4</sup>
	3540	1,196	20,41	11,65

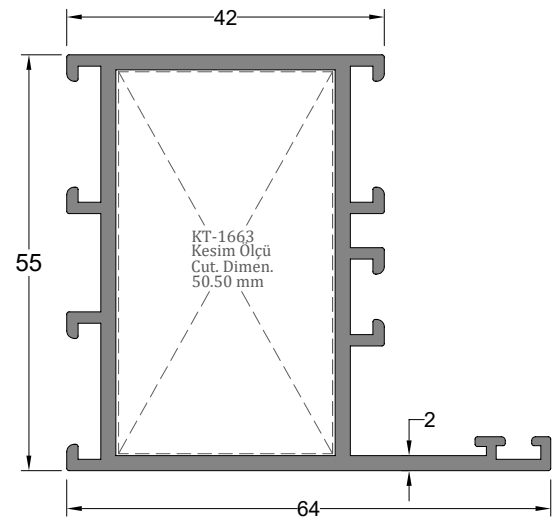

Kasa Profili FRAME PROFILE	Profil Kodu Profile Code	(kg/mt) weight	Jx cm <sup>4</sup>	Jy cm <sup>4</sup>
	1908	1,282	21,75	12,28

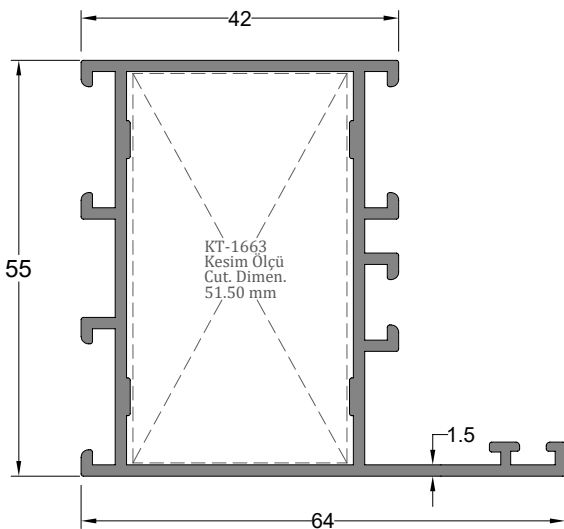

Kasa Profili FRAME PROFILE	Profil Kodu Profile Code	(kg/mt) weight	Jx cm <sup>4</sup>	Jy cm <sup>4</sup>
	11959	1,065	16,36	12,65

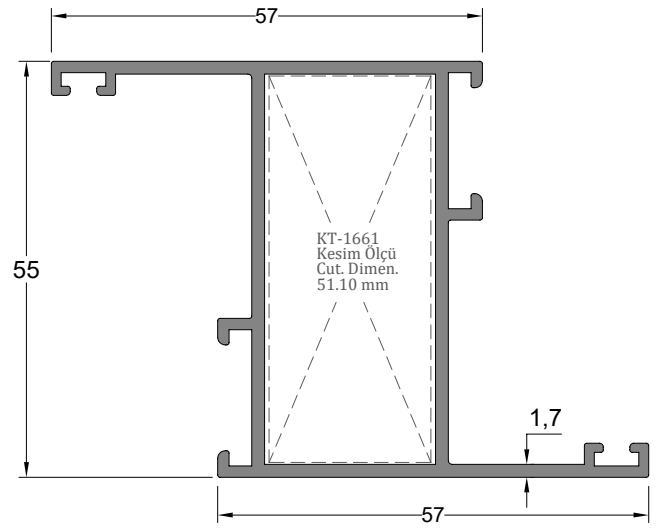

Kasa Profili FRAME PROFILE	Profil Kodu Profile Code	(kg/mt) weight	Jx cm <sup>4</sup>	Jy cm <sup>4</sup>
	5580	1,110	23,41	8,57

\*\* Her profil için minimum sipariş 300 kg'dır.  
\*\* Minimum order quantity is 300 kg per profile.

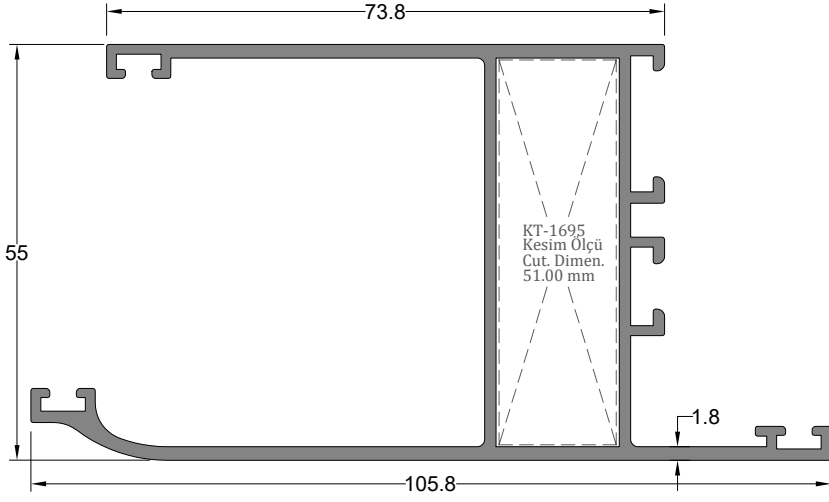

Kasa Profili	Profil Kodu	(kg/mt)	Jx cm <sup>4</sup>	Jy cm <sup>4</sup>
FRAME PROFILE	Profile Code	weight		
	12747	1,462	27,12	38,27

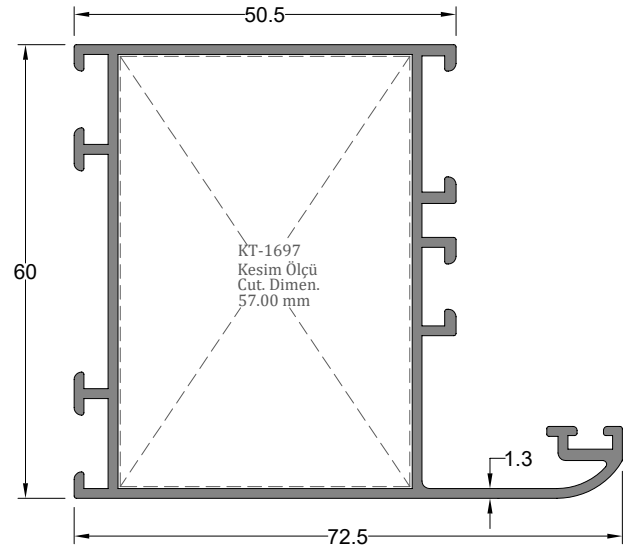

Kasa Profili	Profil Kodu	(kg/mt)	Jx cm <sup>4</sup>	Jy cm <sup>4</sup>
FRAME PROFILE	Profile Code	weight		
	1687	1,064	24,35	15,40

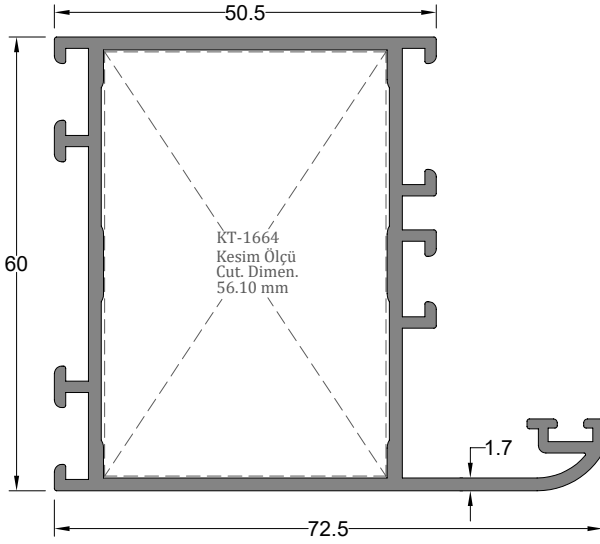

Kasa Profili	Profil Kodu	(kg/mt)	Jx cm <sup>4</sup>	Jy cm <sup>4</sup>
FRAME PROFILE	Profile Code	weight		
	1782	1,347	29,80	18,96

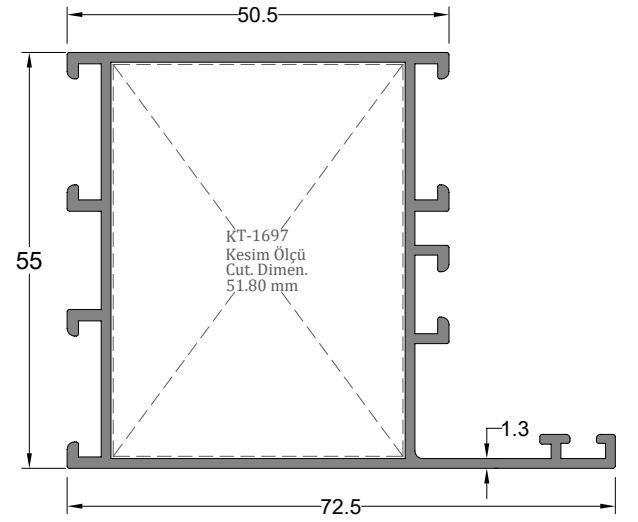

Kasa Profili	Profil Kodu	(kg/mt)	Jx cm <sup>4</sup>	Jy cm <sup>4</sup>
FRAME PROFILE	Profile Code	weight		
	1909	0,993	13,03	19,98

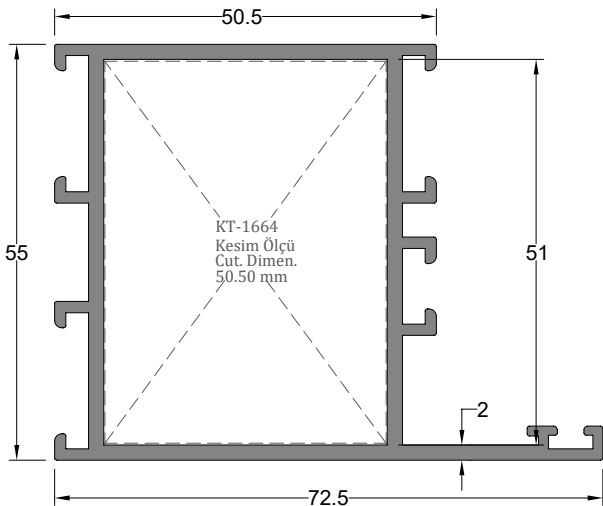

Kasa Profili	Profil Kodu	(kg/mt)	Jx cm <sup>4</sup>	Jy cm <sup>4</sup>
FRAME PROFILE	Profile Code	weight		
	1910	1,374	26,26	17,36

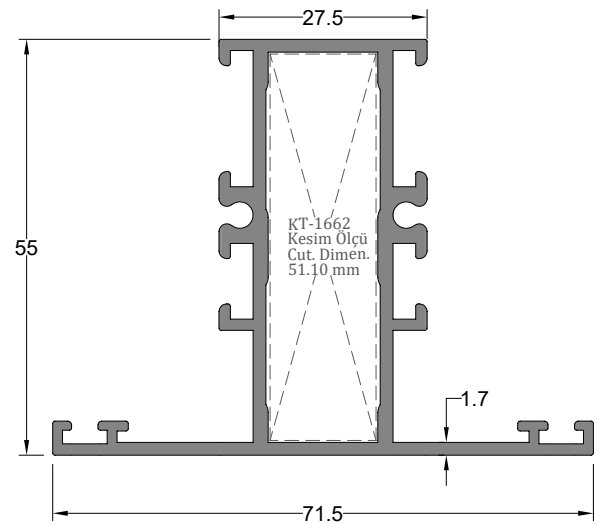

Orta Kayıt Profili	Profil Kodu	(kg/mt)	Jx cm <sup>4</sup>	Jy cm <sup>4</sup>
MULLION PROFILE	Profile Code	weight		
	1790	1,225	16,70	9,90

\*\* Her profil için minimum sipariş 300 kg'dır.  
\*\* Minimum order quantity is 300 kg per profile.

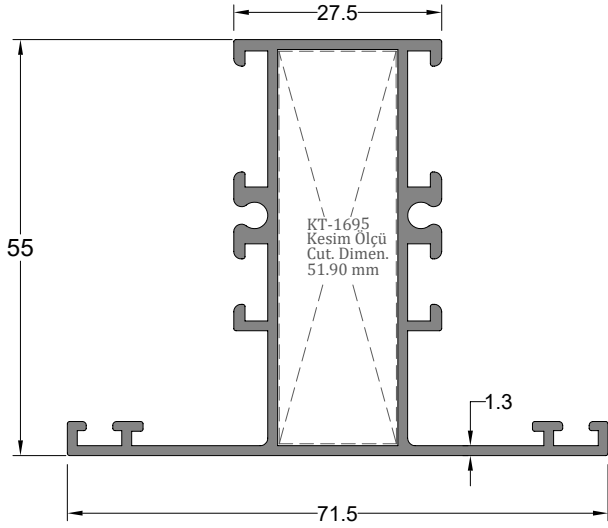

Orta Kayıt Profili	Profil Kodu	(kg/mt)	Jx cm <sup>4</sup>	Jy cm <sup>4</sup>
MULLION PROFILE	1693	1,001	13,72	8,80

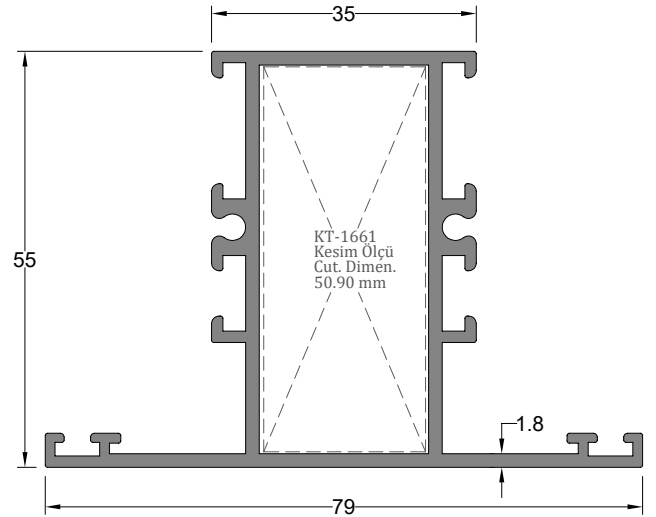

Orta Kayıt Profili	Profil Kodu	(kg/mt)	Jx cm <sup>4</sup>	Jy cm <sup>4</sup>
MULLION PROFILE	5156	1,314	18,95	14,95

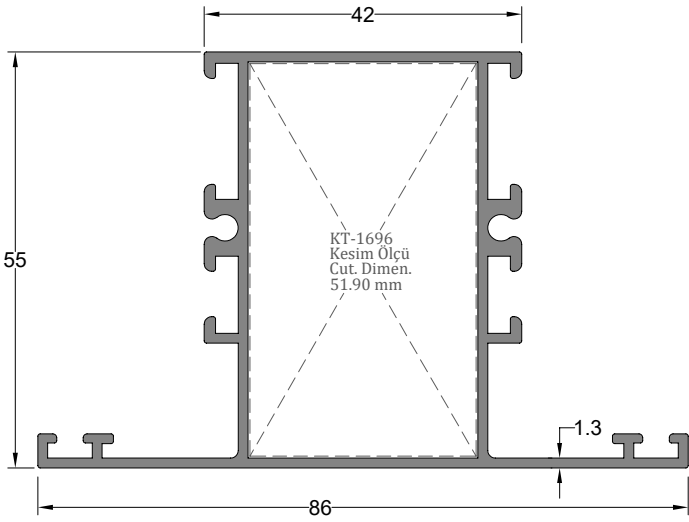

Orta Kayıt Profili	Profil Kodu	(kg/mt)	Jx cm <sup>4</sup>	Jy cm <sup>4</sup>
MULLION PROFILE	1694	1,103	16,53	17,78

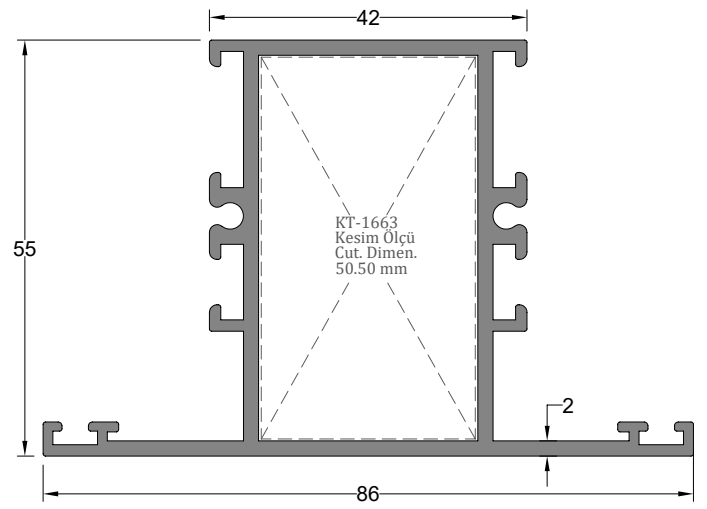

Orta Kayıt Profili	Profil Kodu	(kg/mt)	Jx cm <sup>4</sup>	Jy cm <sup>4</sup>
MULLION PROFILE	1783	1,489	22,39	21,77

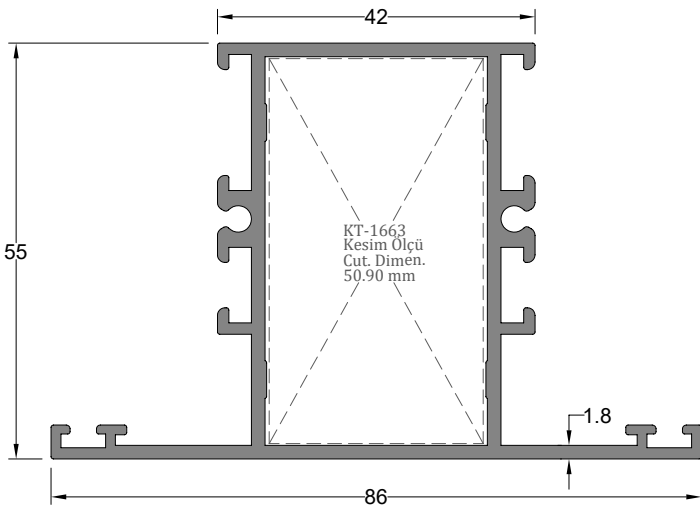

Orta Kayıt Profili	Profil Kodu	(kg/mt)	Jx cm <sup>4</sup>	Jy cm <sup>4</sup>
MULLION PROFILE	3541	1,394	20,91	20,85

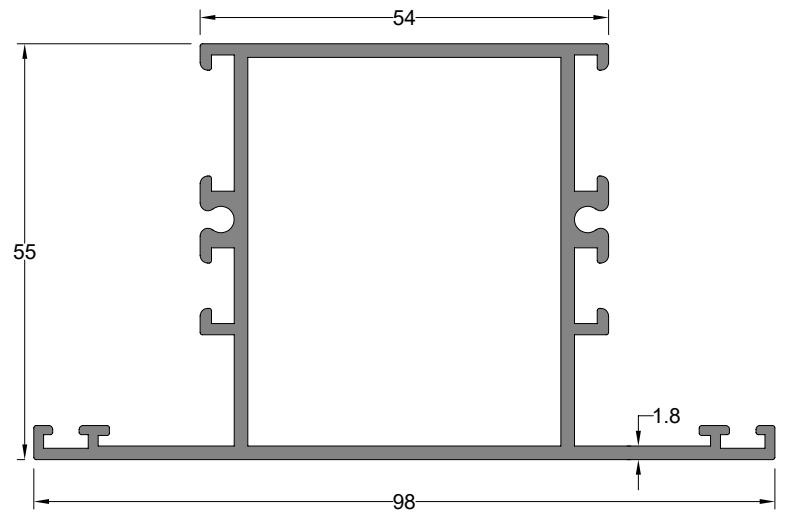

Orta Kayıt Profili	Profil Kodu	(kg/mt)	Jx cm <sup>4</sup>	Jy cm <sup>4</sup>
MULLION PROFILE	1901	1,499	33,67	23,95

\*\* Her profil için minimum sipariş 300 kg'dır.  
\*\* Minimum order quantity is 300 kg per profile.

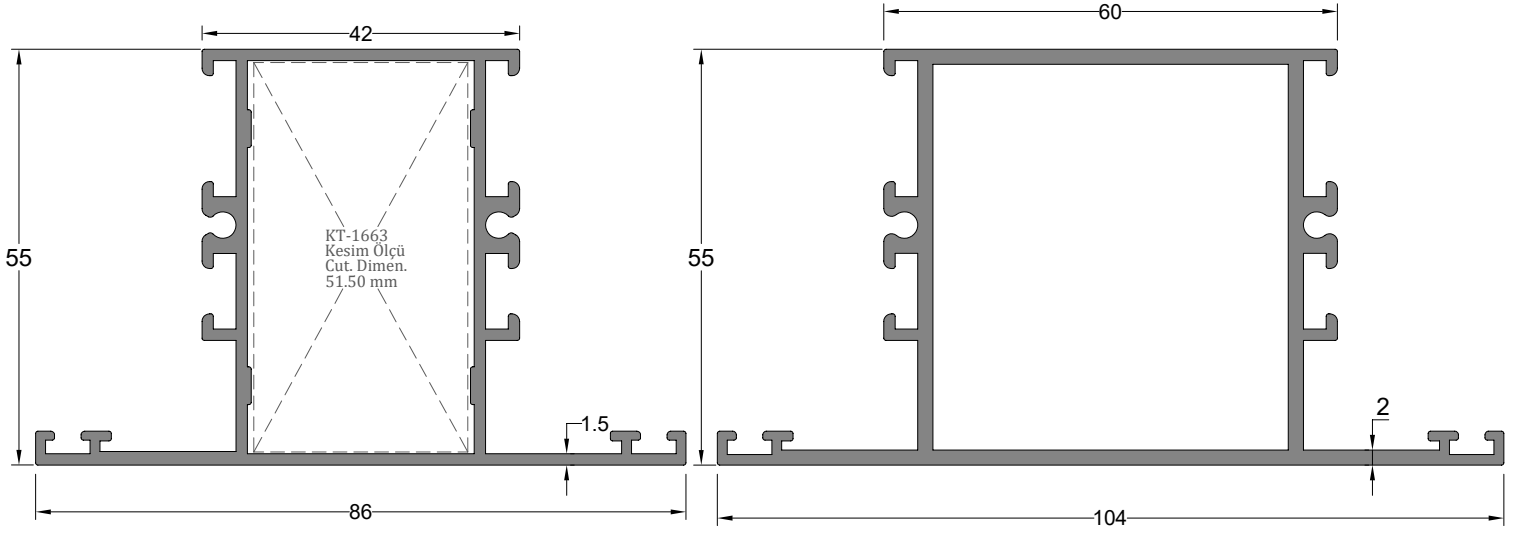

Orta Kayıt Profili	Profil Kodu	(kg/mt)	Jx cm <sup>4</sup>	Jy cm <sup>4</sup>
MULLION PROFILE	Profile Code	weight		
	11960	1,248	19,80	18,86

Orta Kayıt Profili	Profil Kodu	(kg/mt)	Jx cm <sup>4</sup>	Jy cm <sup>4</sup>
MULLION PROFILE	Profile Code	weight		
	5520	1,684	43,70	27,55

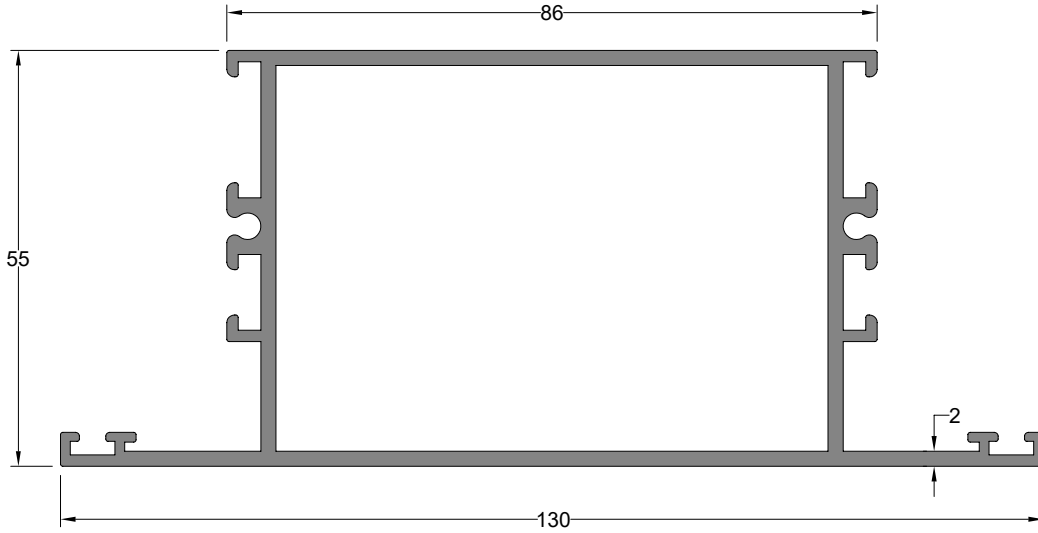

Orta Kayıt Profili	Profil Kodu	(kg/mt)	Jx cm <sup>4</sup>	Jy cm <sup>4</sup>
MULLION PROFILE	Profile Code	weight		
	1788	1,966	94,13	35,07

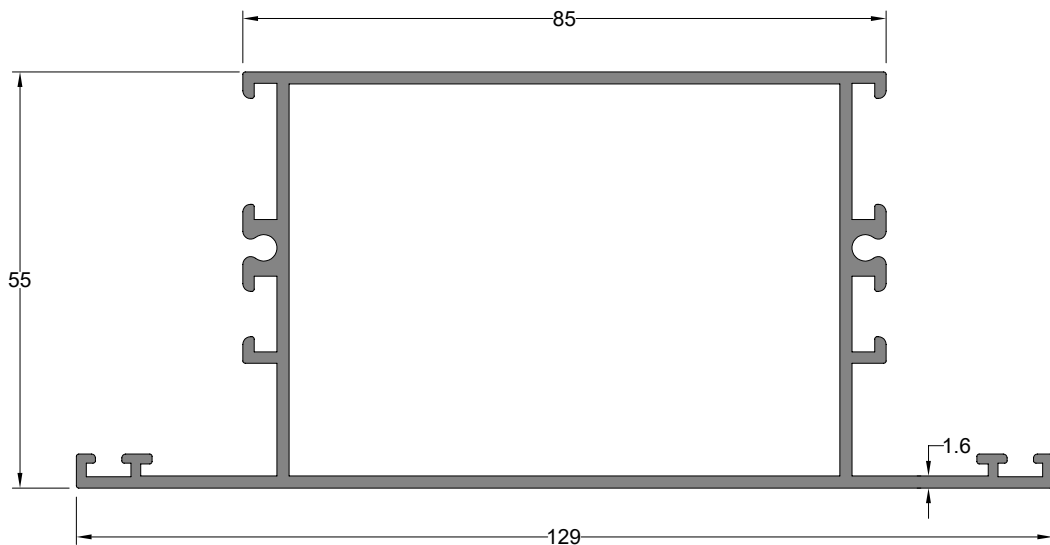

Orta Kayıt Profili	Profil Kodu	(kg/mt)	Jx cm <sup>4</sup>	Jy cm <sup>4</sup>
MULLION PROFILE	Profile Code	weight		
	4687	1,648	80,83	29,30

\*\* Her profil için minimum sipariş 300 kg'dır.  
\*\* Minimum order quantity is 300 kg per profile.

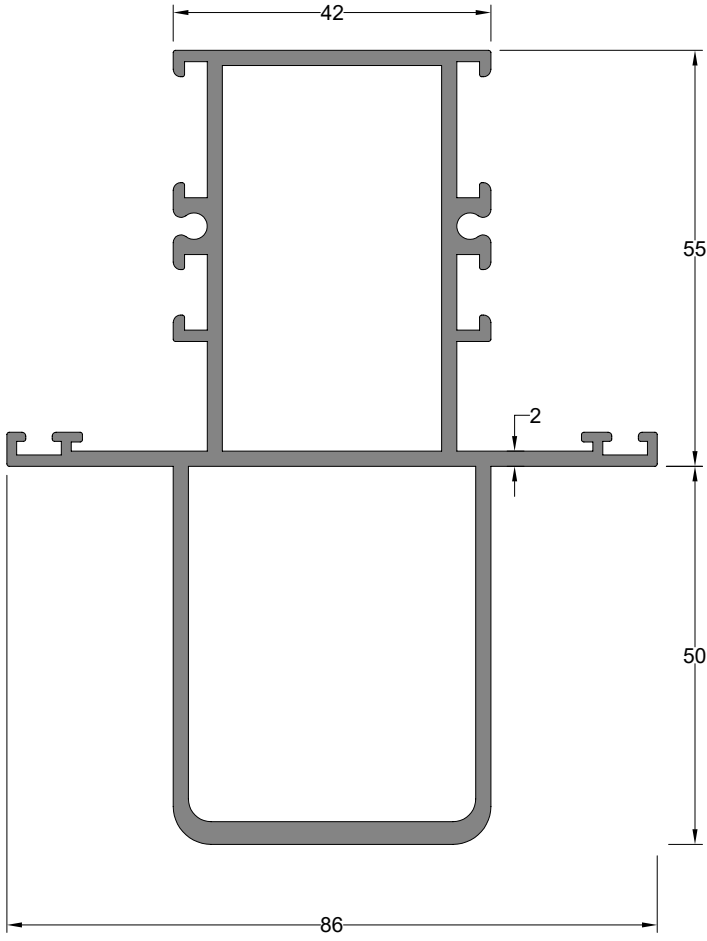

Takviyeli Orta Kayıt Profili REINFORCED MULLION PROFILE	Profil Kodu Profile Code	(kg/mt) weight	Jx cm <sup>4</sup>	Jy cm <sup>4</sup>
	2096	2,321	91,80	30,85

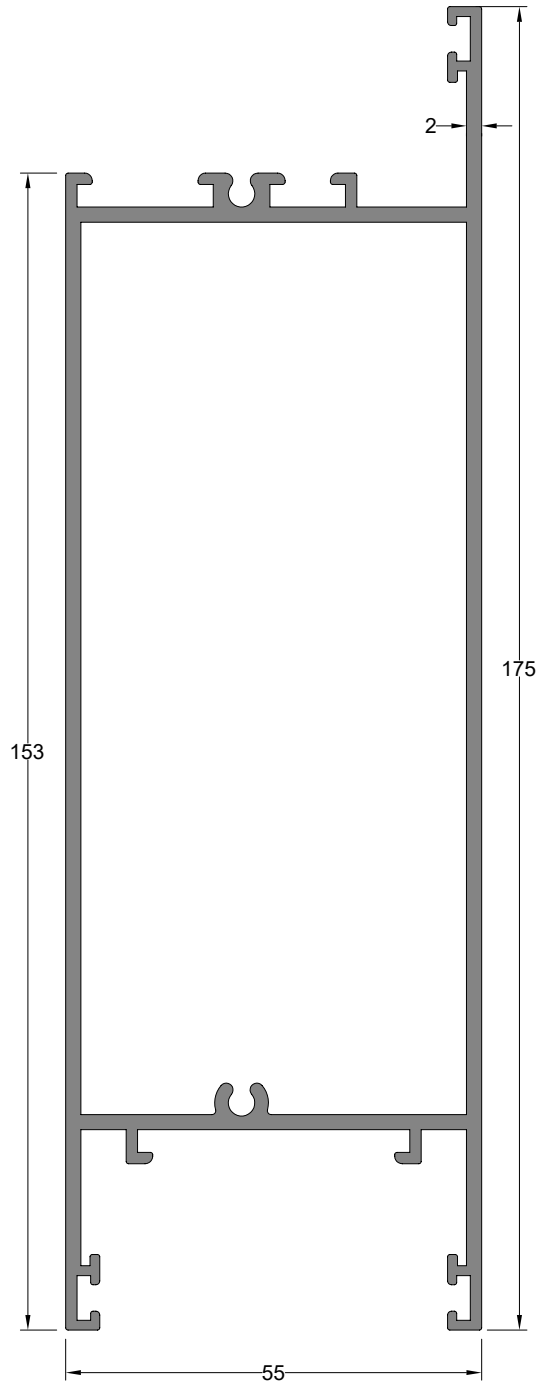

Etek Profili BOTTOM PROFILE	Profil Kodu Profile Code	(kg/mt) weight	Jx cm <sup>4</sup>	Jy cm <sup>4</sup>
	1789	2,588	269,25	26,92



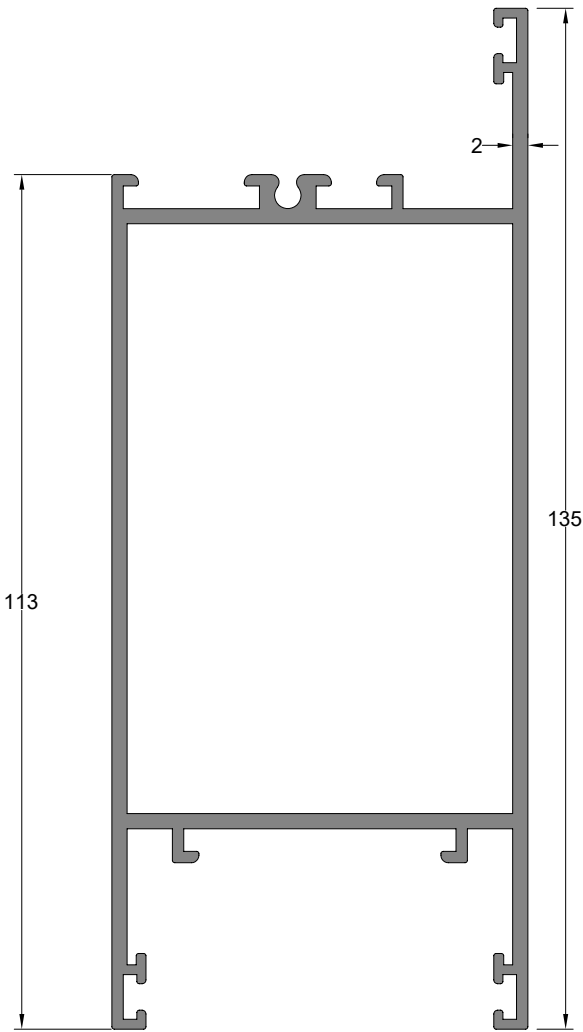

Etek Profili	Profil Kodu	(kg/mt)	Jx cm <sup>4</sup>	Jy cm <sup>4</sup>
BOTTOM PROFILE	Profile Code	weight		
	1902	2,114	120,67	40,40

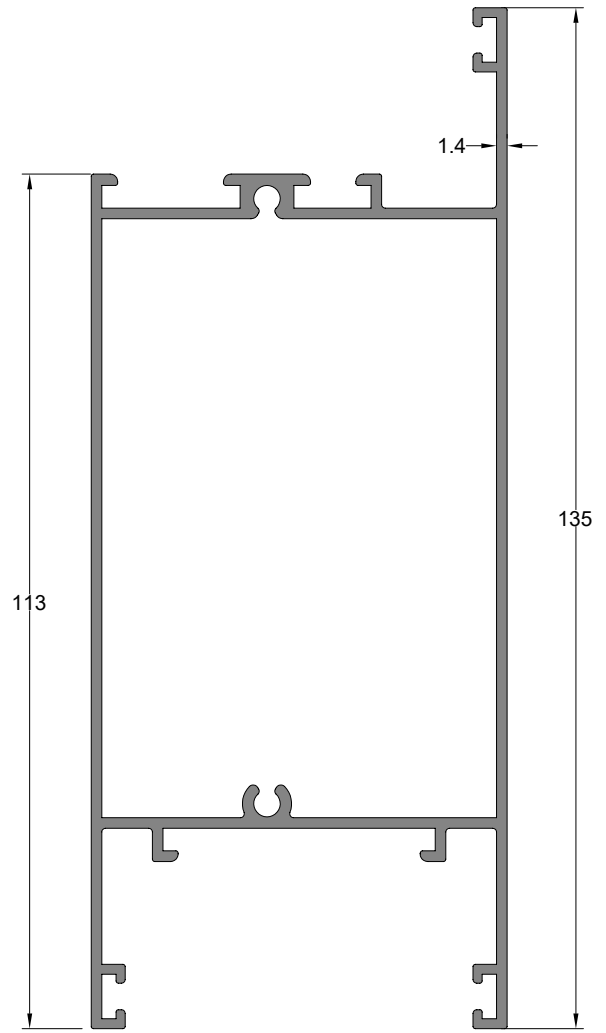

Etek Profili	Profil Kodu	(kg/mt)	Jx cm <sup>4</sup>	Jy cm <sup>4</sup>
BOTTOM PROFILE	Profile Code	weight		
	5519	1,614	96,80	30,35

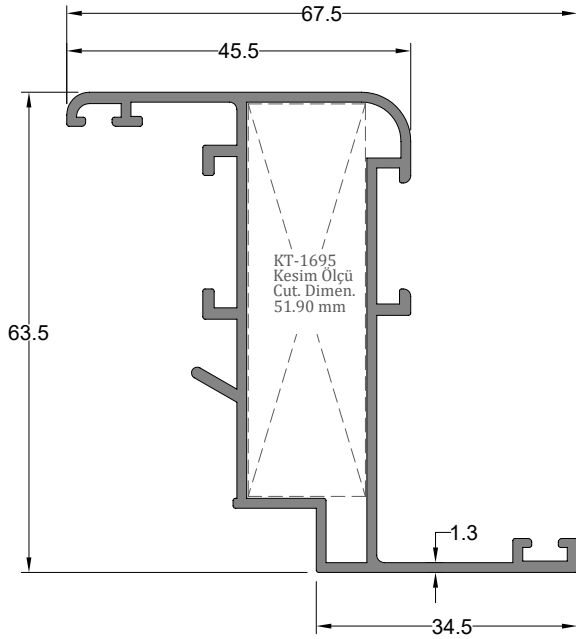

Kanat Profili	Profil Kodu	(kg/mt)	Jx cm <sup>4</sup>	Jy cm <sup>4</sup>
SASH PROFILE	1691	0,933	21,45	4,43

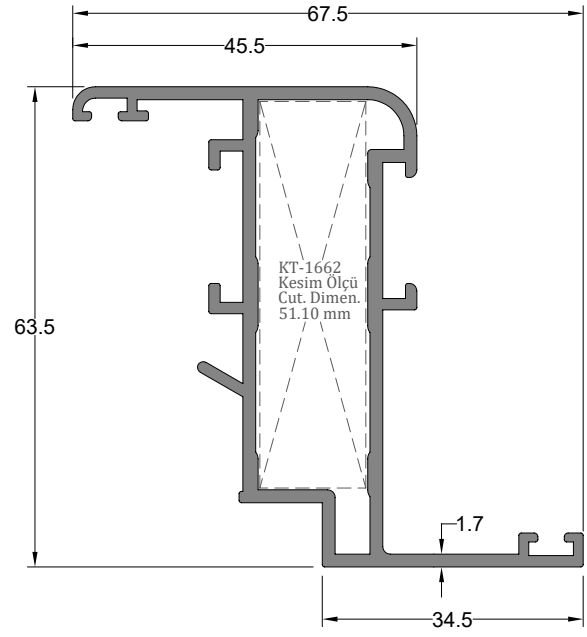

Kanat Profili	Profil Kodu	(kg/mt)	Jx cm <sup>4</sup>	Jy cm <sup>4</sup>
SASH PROFILE	1784	1,180	25,48	5,25

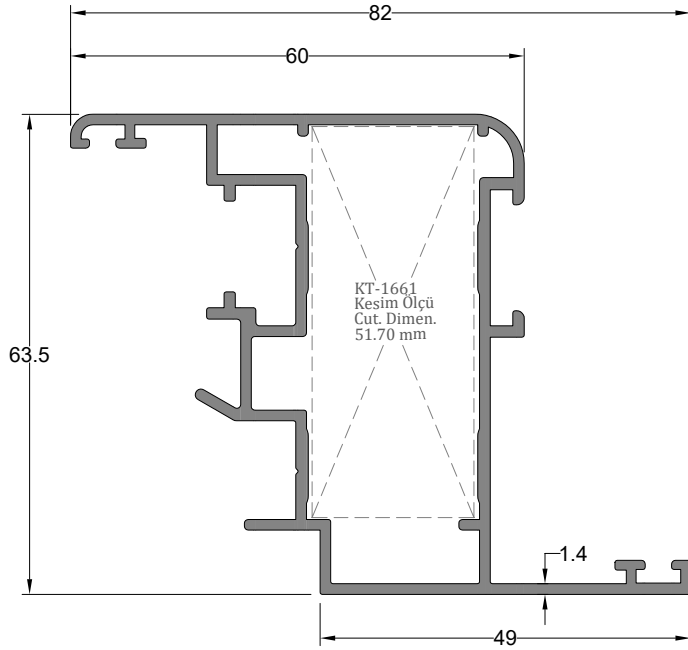

Pvc Kanallı Kanat Profili	Profil Kodu	(kg/mt)	Jx cm <sup>4</sup>	Jy cm <sup>4</sup>
PVC GROOVED SASH PROFILE	12059	1,242	30,17	10,23

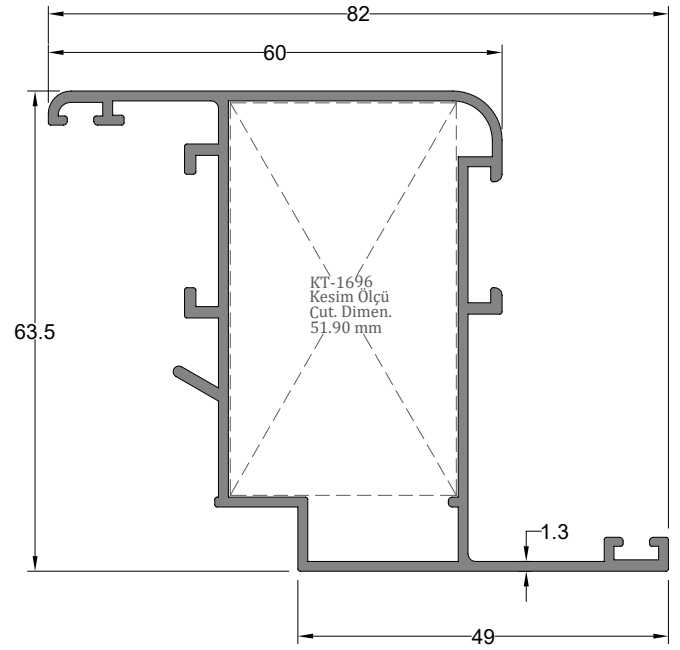

Kanat Profili	Profil Kodu	(kg/mt)	Jx cm <sup>4</sup>	Jy cm <sup>4</sup>
SASH PROFILE	1692	1,039	28,00	9,68

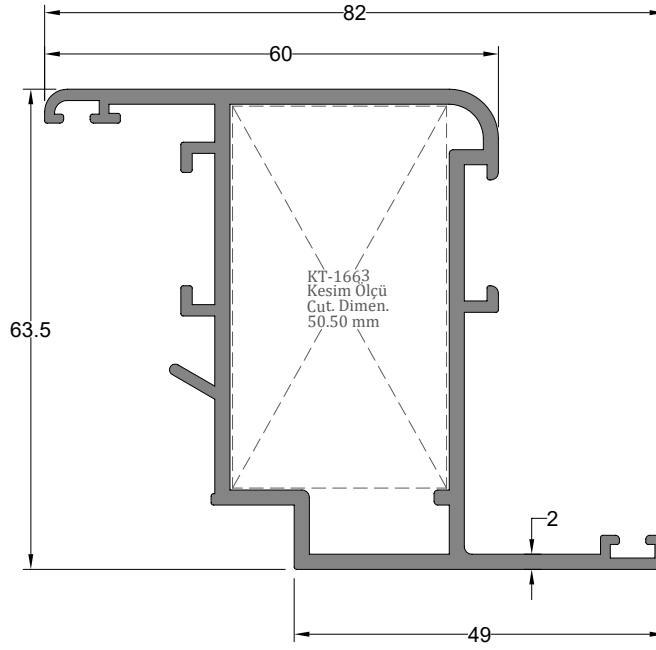

Kanat Profili SASH PROFILE	Profil Kodu Profile Code	(kg/mt) weight	Jx cm <sup>4</sup>	Jy cm <sup>4</sup>
	1785	1,467	36,60	13,16

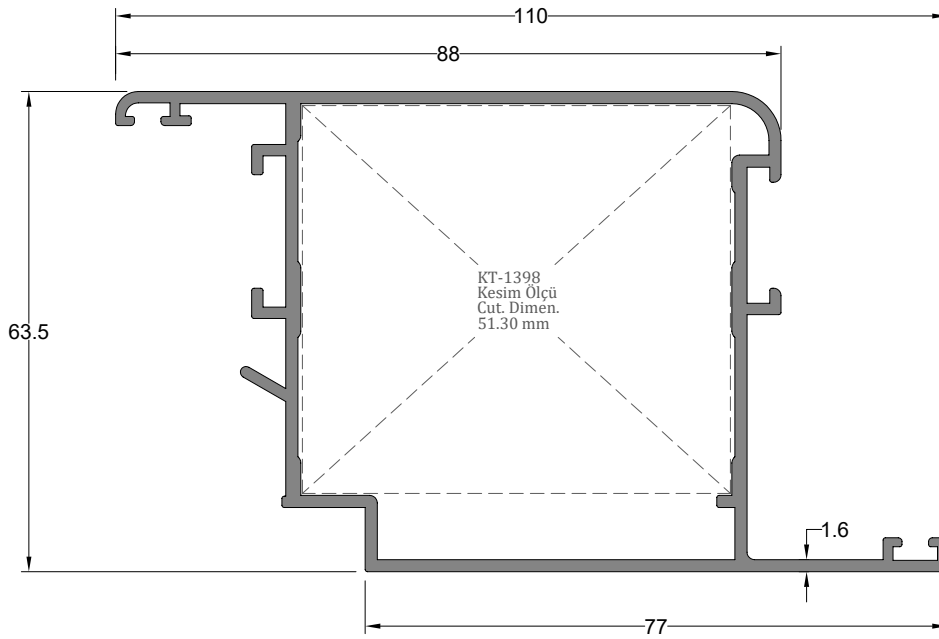

Kanat Profili SASH PROFILE	Profil Kodu Profile Code	(kg/mt) weight	Jx cm <sup>4</sup>	Jy cm <sup>4</sup>
	1660	1,516	57,98	26,80

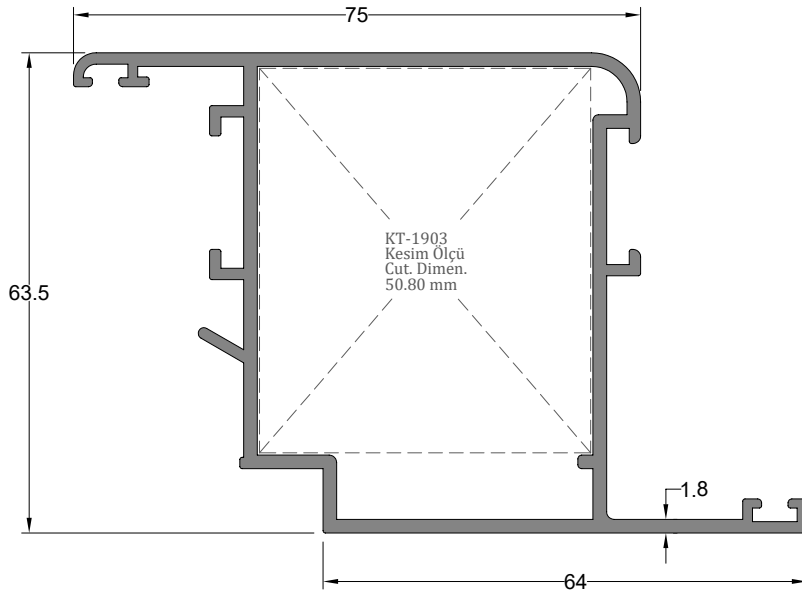

Kanat Profili SASH PROFILE	Profil Kodu Profile Code	(kg/mt) weight	Jx cm <sup>4</sup>	Jy cm <sup>4</sup>
	1900	1,497	45,78	21,39

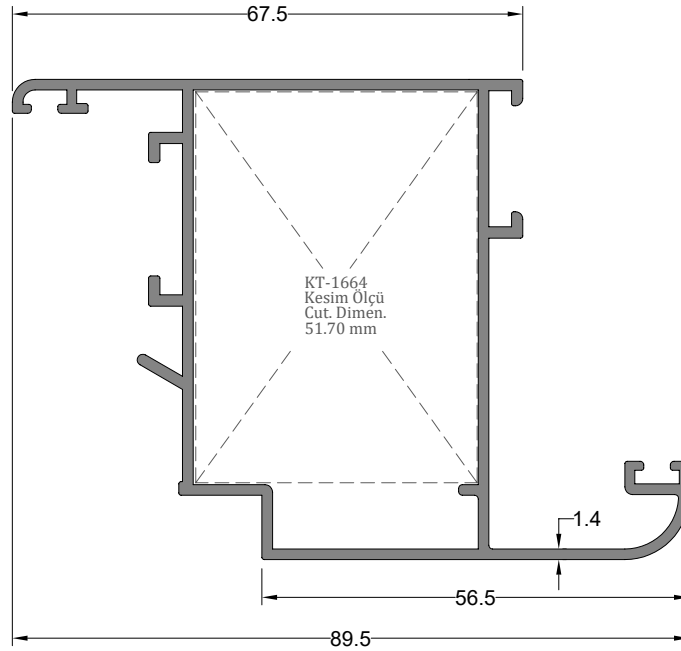

Kanat Profili SASH PROFILE	Profil Kodu Profile Code	(kg/mt) weight	Jx cm <sup>4</sup>	Jy cm <sup>4</sup>
	5157	1,206	36,33	14,46

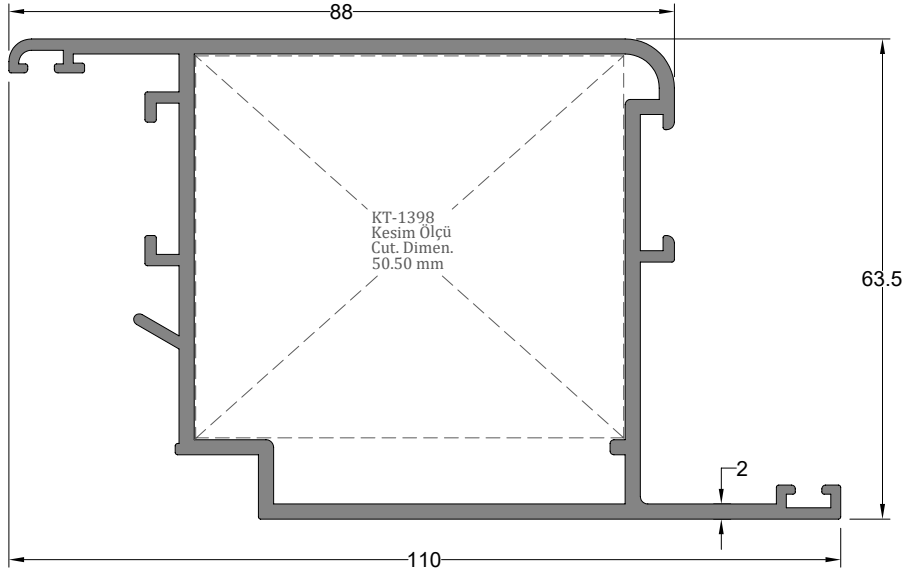

Kanat Profili SASH PROFILE	Profil Kodu Profile Code	(kg/mt) weight	Jx cm <sup>4</sup>	Jy cm <sup>4</sup>
	1787	1,772	65,32	31,83

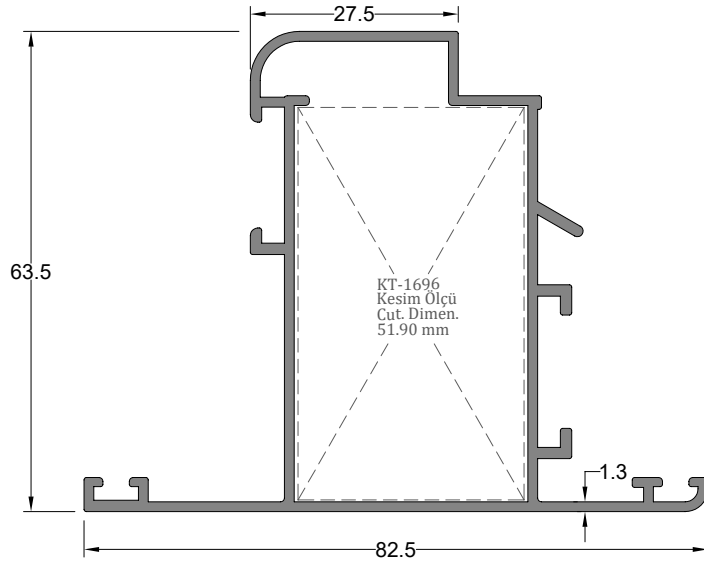

Dışa Açılır Kanat Profili OUTWARD OPENING SASH PROFILE	Profil Kodu Profile Code	(kg/mt) weight	Jx cm <sup>4</sup>	Jy cm <sup>4</sup>
	3545	1,052	20,64	15,61

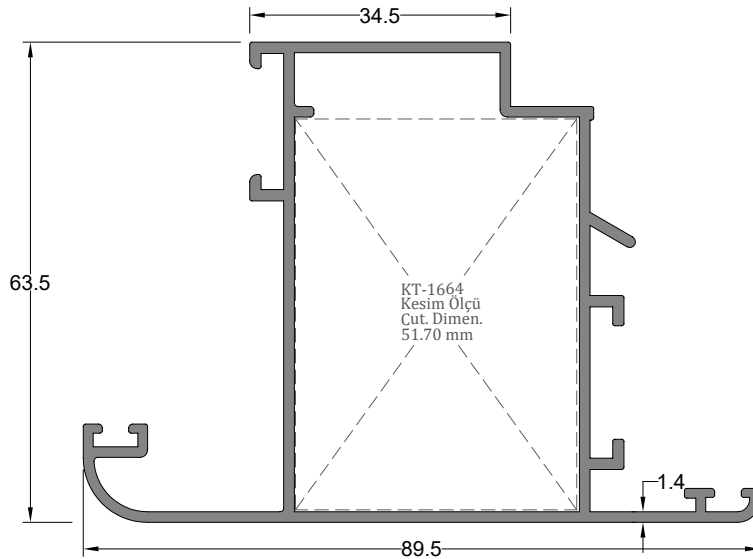

Dışa Açılır Kanat Profili OUTWARD OPENING SASH PROFILE	Profil Kodu Profile Code	(kg/mt) weight	Jx cm <sup>4</sup>	Jy cm <sup>4</sup>
	5158	1,206	25,00	23,93

\*\* Her profil için minimum sipariş 300 kg'dır.  
\*\* Minimum order quantity is 300 kg per profile.

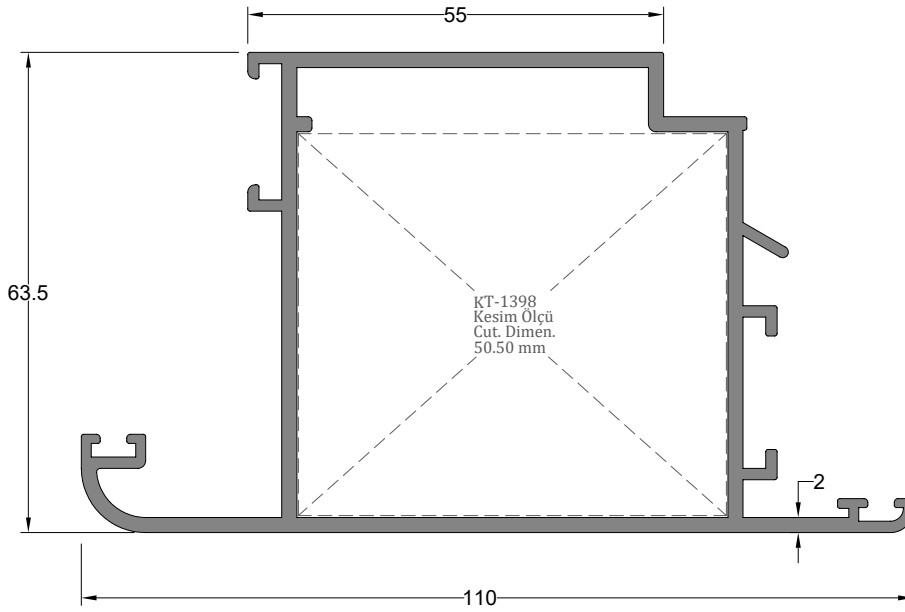

Dışa Açılır Kanat Profili OUTWARD OPENING SASH PROFILE	Profil Kodu Profile Code	(kg/mt) weight	Jx cm <sup>4</sup>	Jy cm <sup>4</sup>
	1786	1,820	61,35	40,05

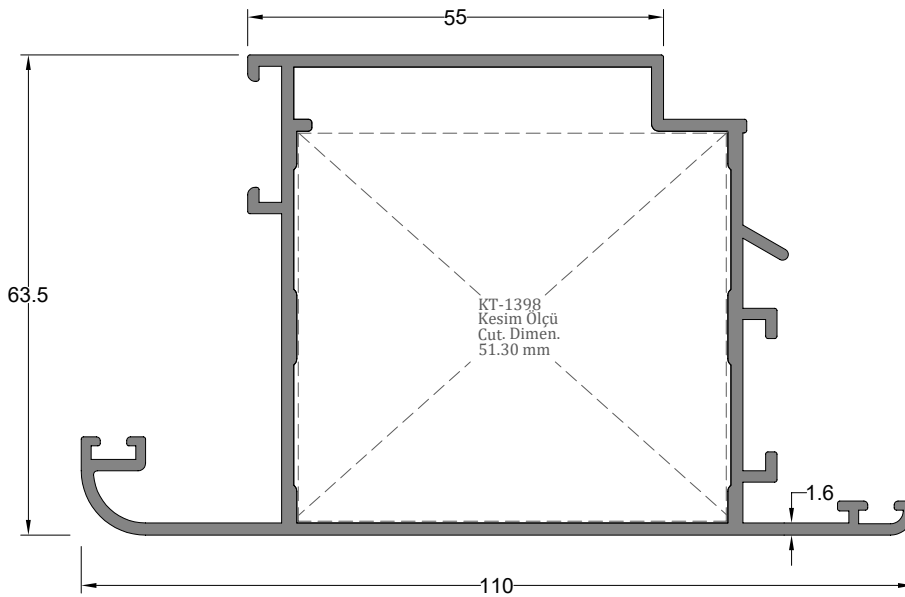

Dışa Açılır Kanat Profili OUTWARD OPENING SASH PROFILE	Profil Kodu Profile Code	(kg/mt) weight	Jx cm <sup>4</sup>	Jy cm <sup>4</sup>
	3943	1,559	54,57	33,87

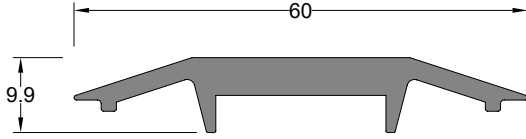

Adaptör Profili ADAPTER PROFILE	Profil Kodu Profile Code	(kg/mt) weight
	1795	0,638

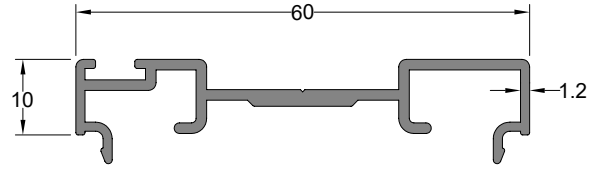

Adaptör Profili ADAPTER PROFILE	Profil Kodu Profile Code	(kg/mt) weight
	1794	0,461

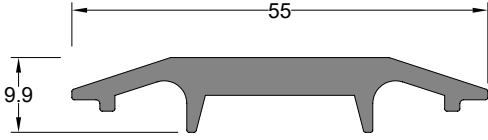

Adaptör Profili ADAPTER PROFILE	Profil Kodu Profile Code	(kg/mt) weight
	1913	0,621

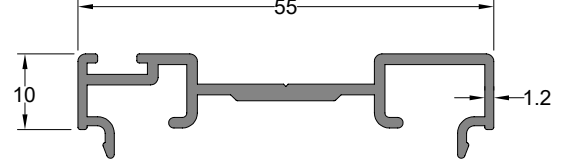

Adaptör Profili ADAPTER PROFILE	Profil Kodu Profile Code	(kg/mt) weight
	1779	0,439

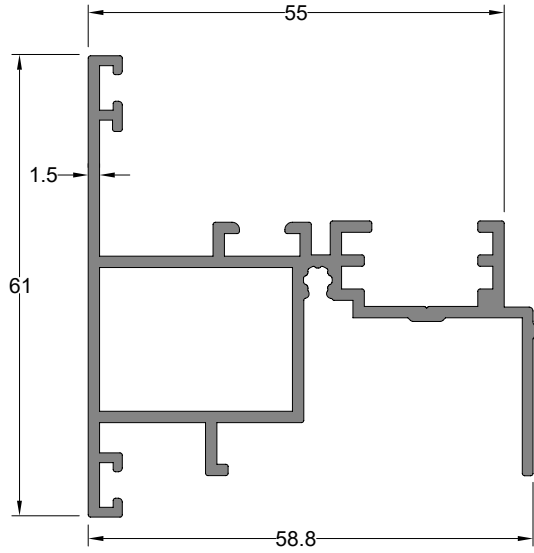

Adaptör Profili ADAPTER PROFILE	Profil Kodu Profile Code	(kg/mt) weight
	11925	1,065

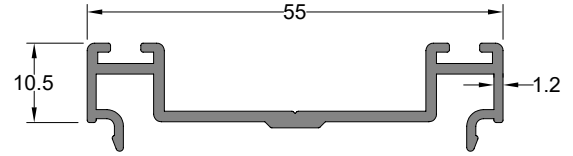

Adaptör Profili ADAPTER PROFILE	Profil Kodu Profile Code	(kg/mt) weight
	6569	0,419

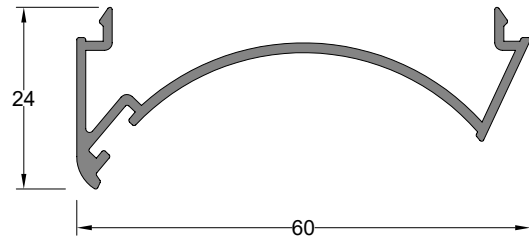

Köşe Dönüş Profili CORNER PROFILE	Profil Kodu Profile Code	(kg/mt) weight
	9664	0,399

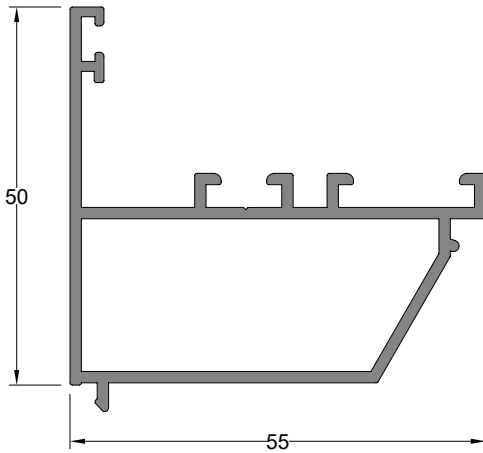

Dışa Açılır Adaptör Profili OUTWARD OPENING ADAPTER PROFILE	Profil Kodu Profile Code	(kg/mt) weight
	1792	0,829

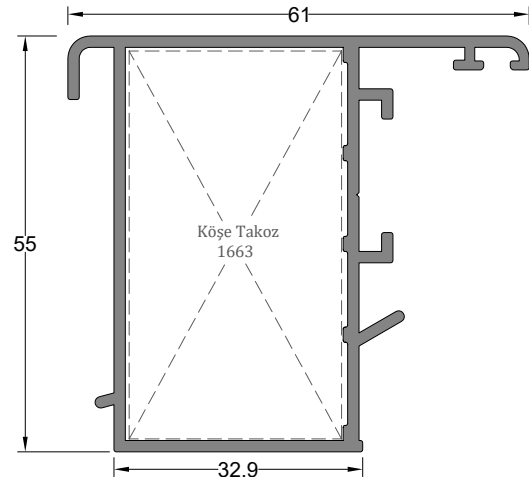

Pivot Adaptör Profili PIVOT ADAPTER PROFILE	Profil Kodu Profile Code	(kg/mt) weight
	1793	0,950

\*\* Her profil için minimum sipariş 300 kg'dır.  
\*\* Minimum order quantity is 300 kg per profile.

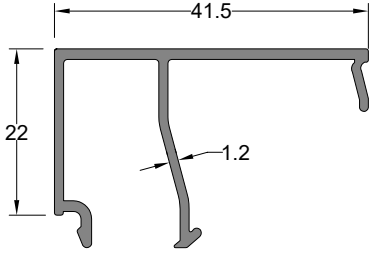

Cam Çıtası	Profil Kodu	(kg/mt)
GLAZING BEAD	Profile Code	Weight
	3537	0,367

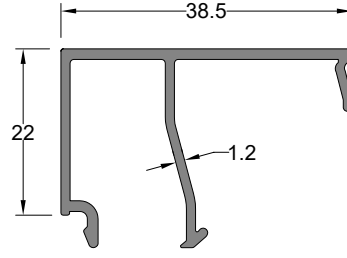

Cam Çıtası	Profil Kodu	(kg/mt)
GLAZING BEAD	Profile Code	Weight
	1749	0,356

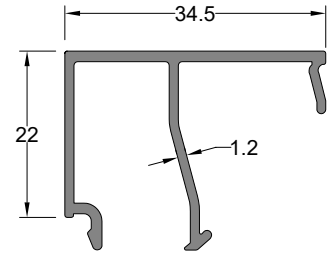

Cam Çıtası	Profil Kodu	(kg/mt)
GLAZING BEAD	Profile Code	Weight
	1747	0,340

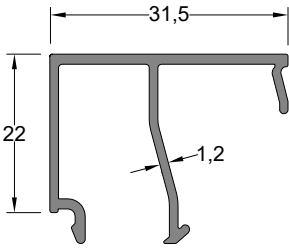

Cam Çıtası	Profil Kodu	(kg/mt)
GLAZING BEAD	Profile Code	Weight
	3536	0,329

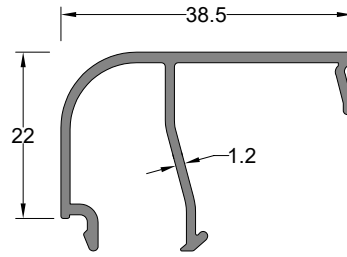

Cam Çıtası	Profil Kodu	(kg/mt)
GLAZING BEAD	Profile Code	Weight
	1750	0,342

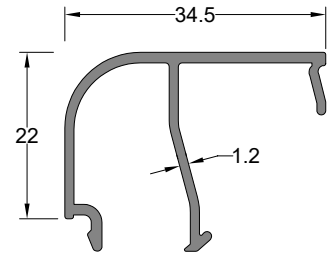

Cam Çıtası	Profil Kodu	(kg/mt)
GLAZING BEAD	Profile Code	Weight
	1748	0,327

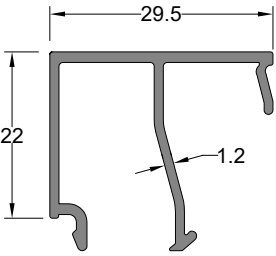

Cam Çıtası	Profil Kodu	(kg/mt)
GLAZING BEAD	Profile Code	Weight
	3636	0,321

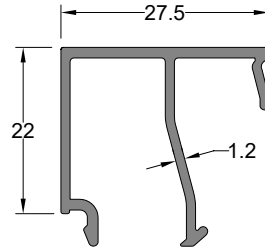

Cam Çıtası	Profil Kodu	(kg/mt)
GLAZING BEAD	Profile Code	Weight
	1966	0,314

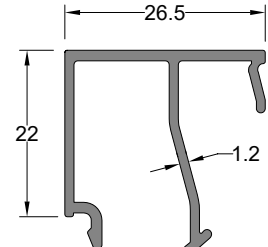

Cam Çıtası	Profil Kodu	(kg/mt)
GLAZING BEAD	Profile Code	Weight
	2236	0,310

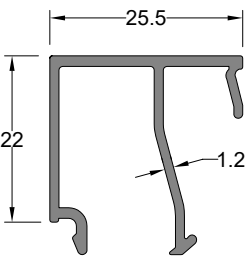

Cam Çıtası	Profil Kodu	(kg/mt)
GLAZING BEAD	Profile Code	Weight
	1949	0,306

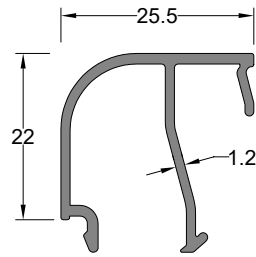

Cam Çıtası	Profil Kodu	(kg/mt)
GLAZING BEAD	Profile Code	Weight
	5527	0,293

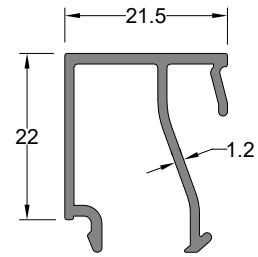

Cam Çıtası	Profil Kodu	(kg/mt)
GLAZING BEAD	Profile Code	Weight
	1745	0,292



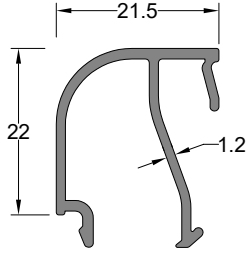

Cam Çıtası GLAZING BEAD	Profil Kodu Profile Code	(kg/mt) Weight
	1746	0,279

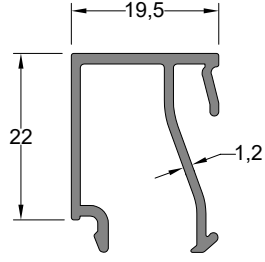

Cam Çıtası GLAZING BEAD	Profil Kodu Profile Code	(kg/mt) Weight
	1699	0,285

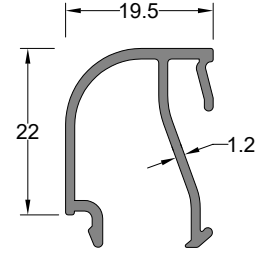

Cam Çıtası GLAZING BEAD	Profil Kodu Profile Code	(kg/mt) Weight
	5546	0,271

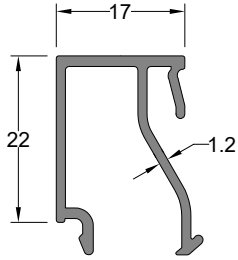

Cam Çıtası GLAZING BEAD	Profil Kodu Profile Code	(kg/mt) Weight
	3539	0,277

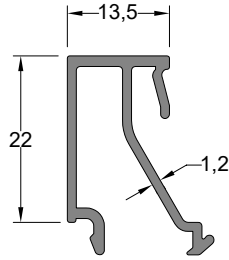

Cam Çıtası GLAZING BEAD	Profil Kodu Profile Code	(kg/mt) Weight
	1698	0,253

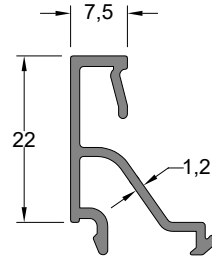

Cam Çıtası GLAZING BEAD	Profil Kodu Profile Code	(kg/mt) Weight
	1948	0,225

CAM ÇİTASI GLAZING BEAD	CAM ÇİTASI UZUNLUĞU GLAZING BEAD LENGTH	İÇ CAM FİTİLİ GLAZING GASKET(inside)	CAM KALINLIĞI GLASS THICKNESS	DIŞ CAM FİTİLİ GLAZING GASKET(outside)
(G)	(L)	(I)	(T)	(O)
1749	38,5 mm	İCF.50	4 mm	DCF.30
1750	38,5 mm	İCF.40	5 mm	DCF.30
1749	38,5 mm	İCF.30	6 mm	DCF.30
1747	34,5 mm	İCF.50	7 mm	DCF.45
1747	34,5 mm	İCF.50	8 mm	DCF.30
1748	34,5 mm	İCF.40	9 mm	DCF.30
1747	34,5 mm	İCF.30	10 mm	DCF.30
1747	34,5 mm	İCF.50	11 mm	DCF.30
3536	31,5 mm	İCF.40	12 mm	DCF.30
3536	31,5 mm	İCF.30	13 mm	DCF.30
3636	29,5 mm	İCF.40	14 mm	DCF.30
3636	29,5 mm	İCF.30	15 mm	DCF.30
1966	27,5 mm	İCF.40	16 mm	DCF.30
2236	26,5 mm	İCF.40	17 mm	DCF.30
1949	25,5 mm	İCF.40	18 mm	DCF.30
5527	25,5 mm	İCF.30	19 mm	DCF.30
1745	21,5 mm	İCF.50	20 mm	DCF.45
1745	21,5 mm	İCF.50	21 mm	DCF.30
1745	21,5 mm	İCF.40	22 mm	DCF.30
1746	21,5 mm	İCF.30	23 mm	DCF.30
5546	19,5 mm	İCF.40	24 mm	DCF.30

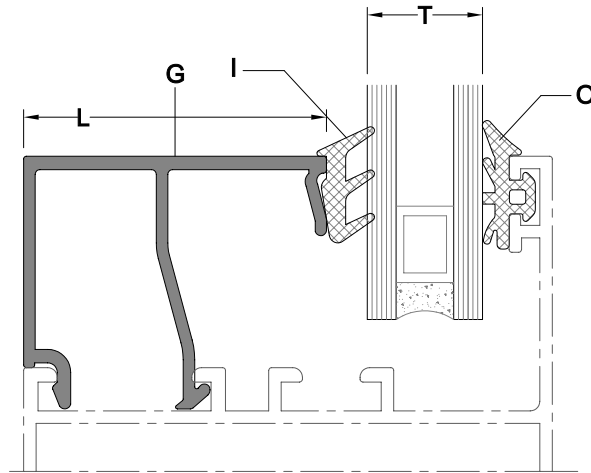



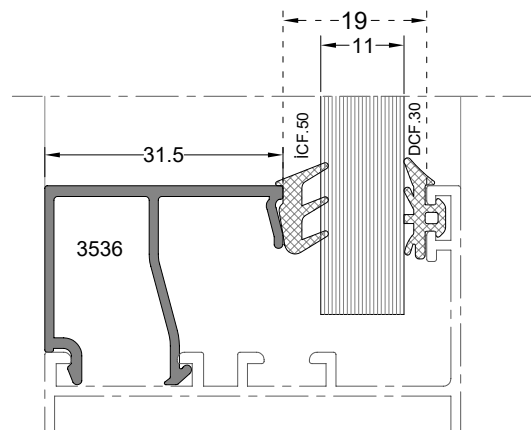
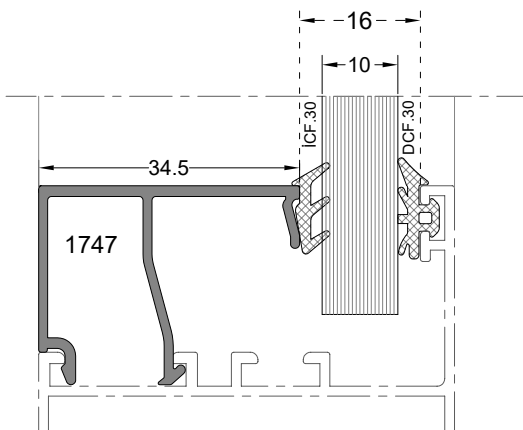
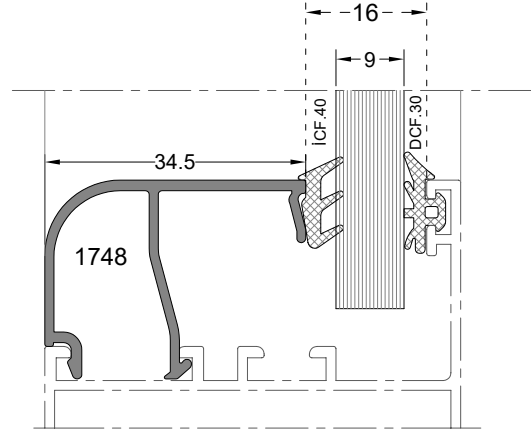
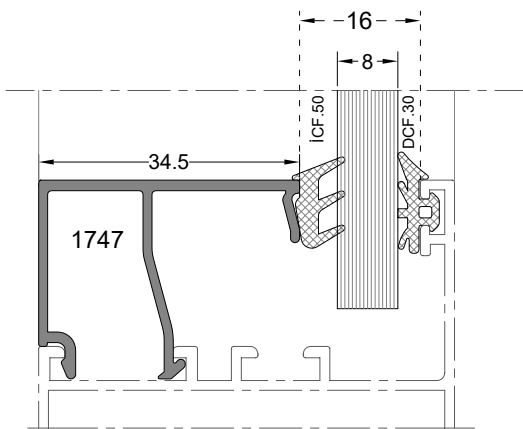
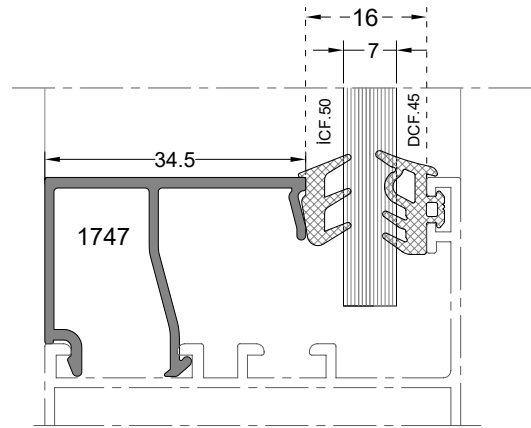
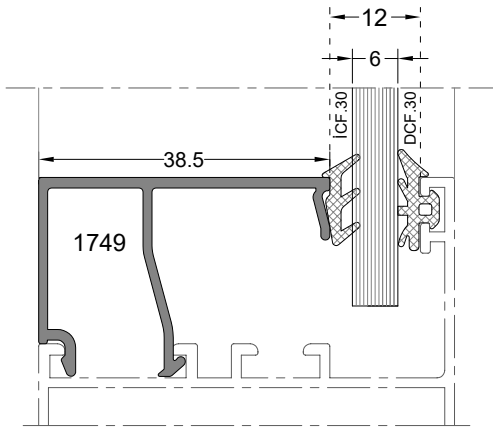
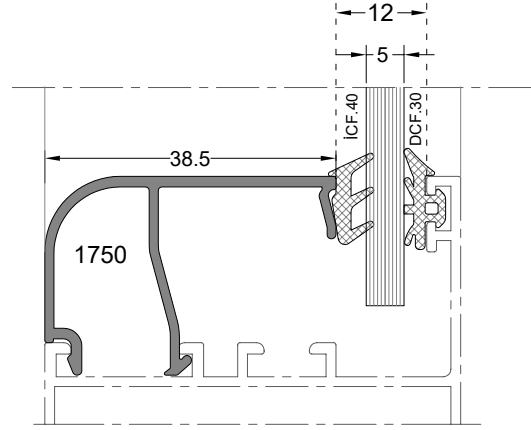
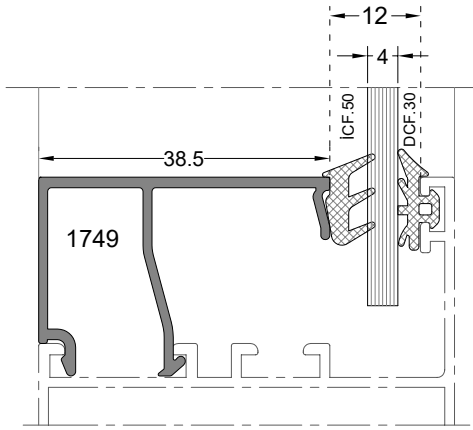

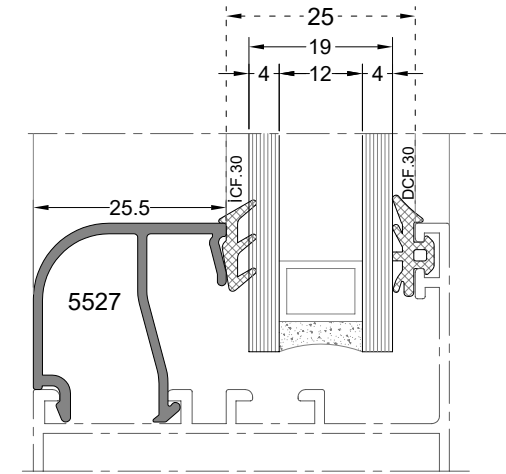
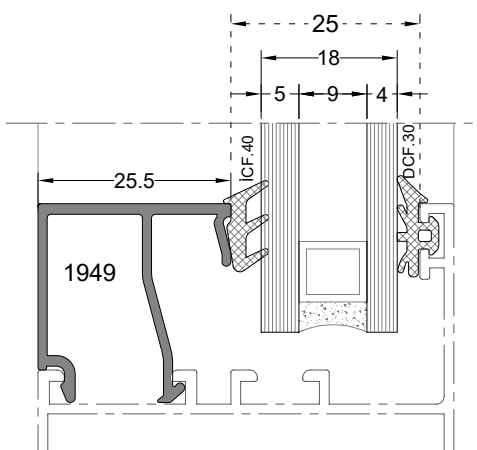
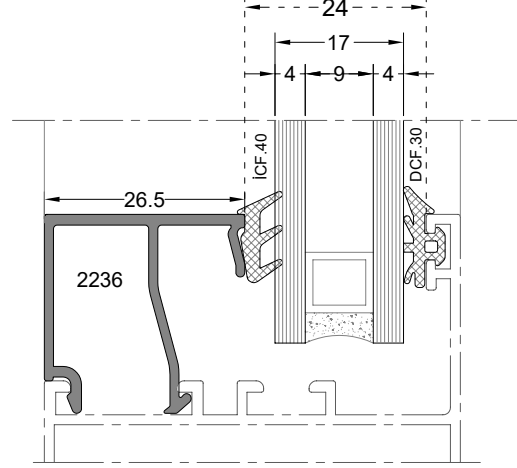
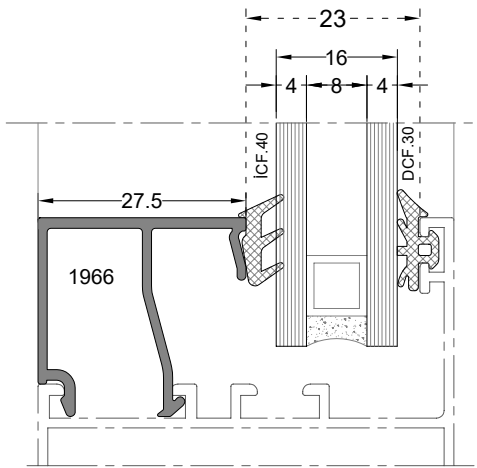
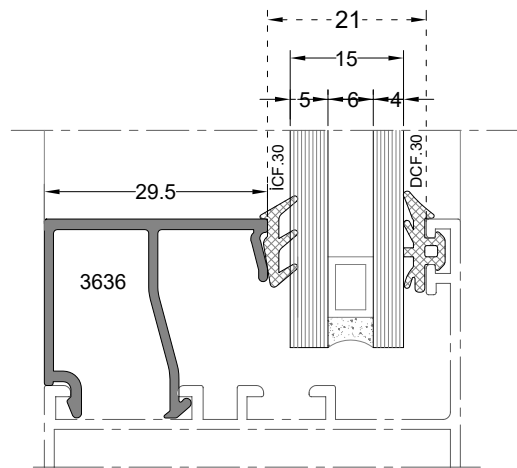
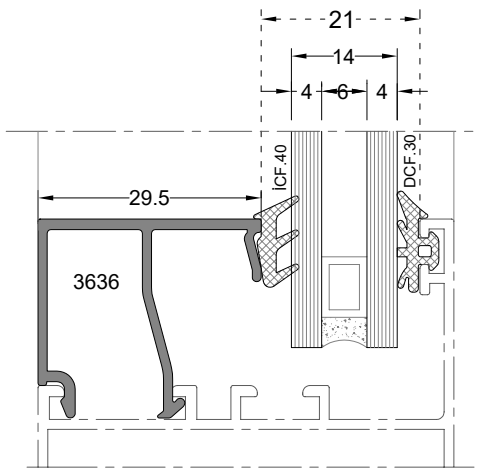
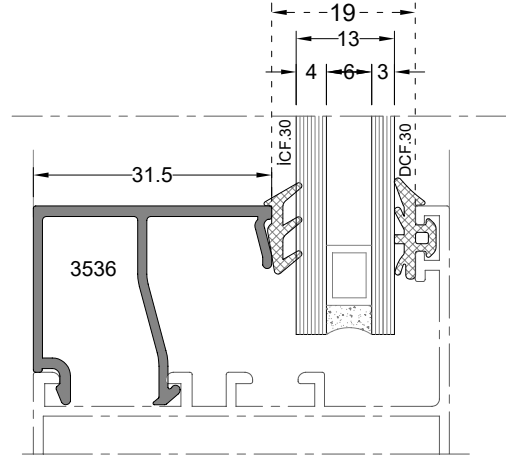
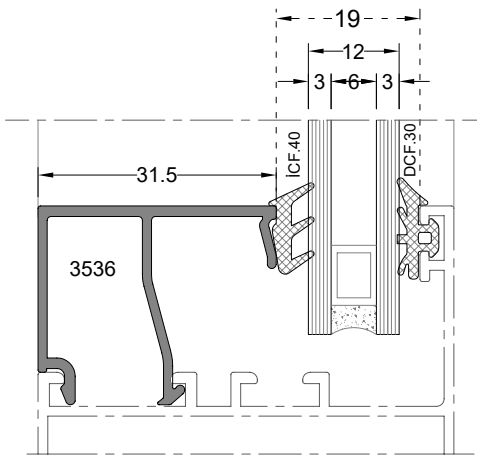

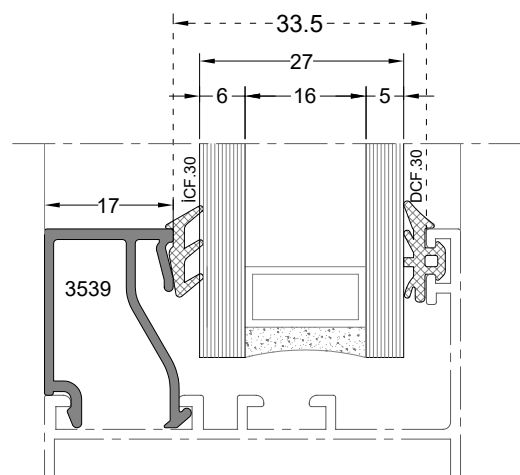
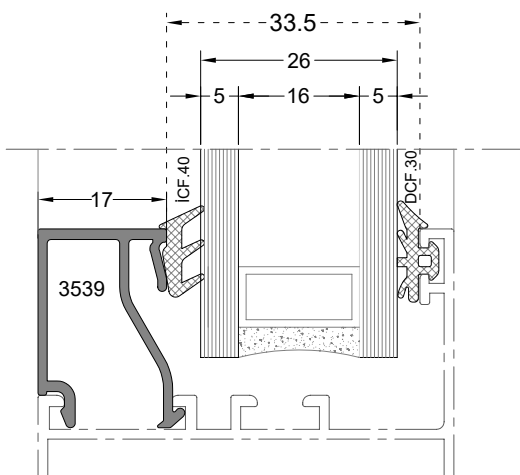
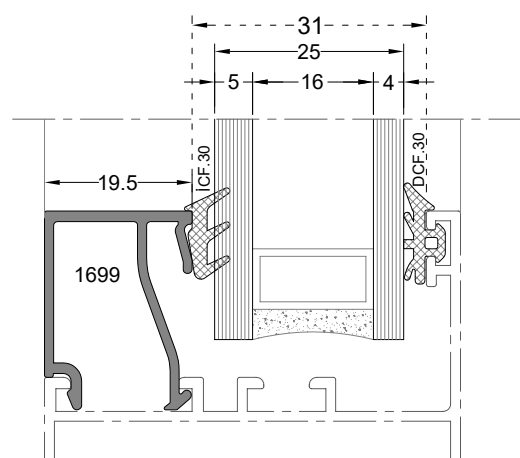
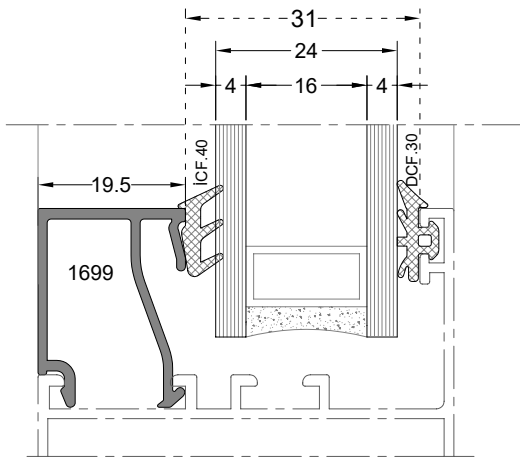
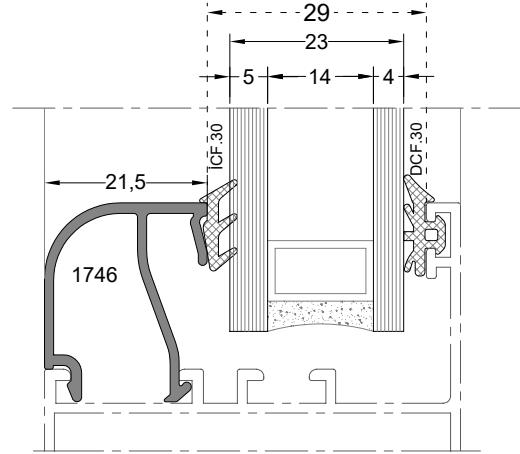
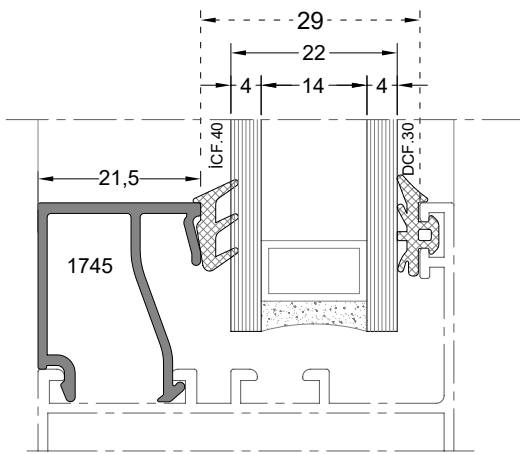
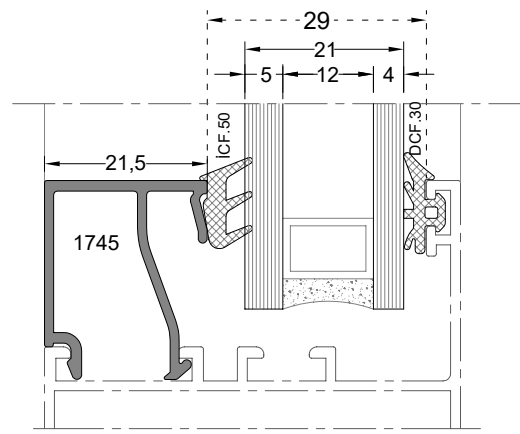
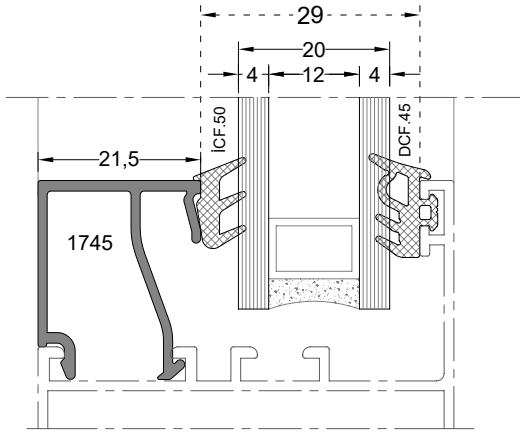

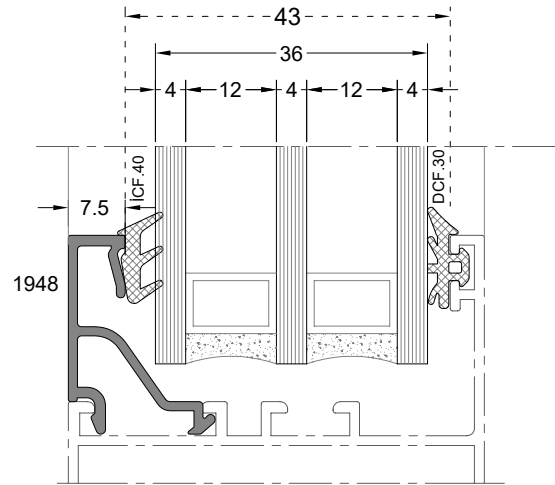
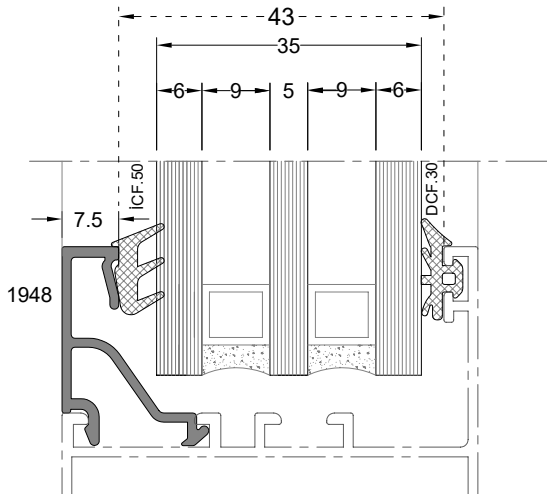
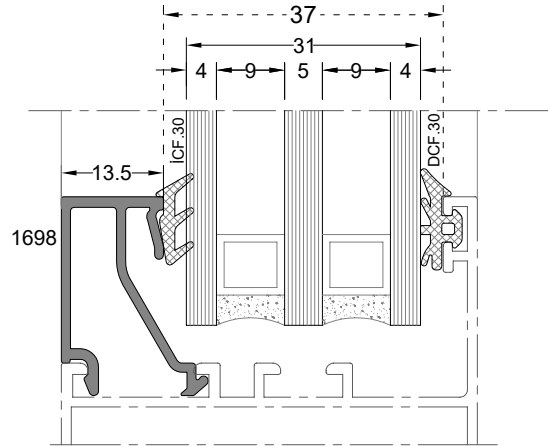
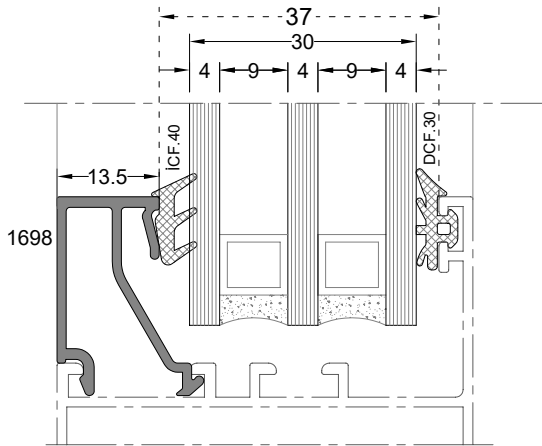
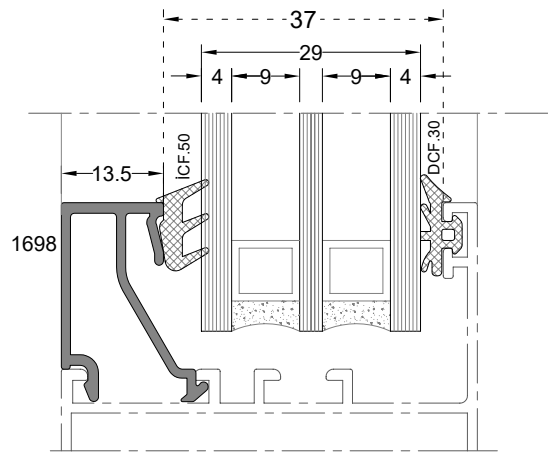
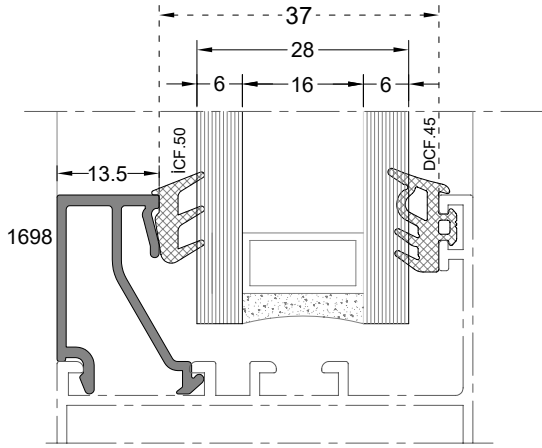

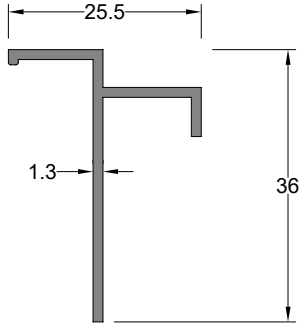

T Bağlantı Profili T CONNECTION PROFILE	Profil Kodu Profile Code	(kg/mt) Weight
	1121	0,233

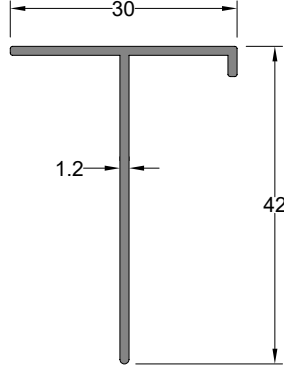

T Bağlantı Profili T CONNECTION PROFILE	Profil Kodu Profile Code	(kg/mt) Weight
	1035	0,240

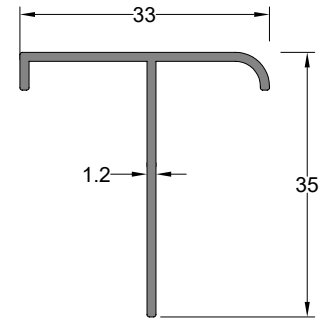

T Bağlantı Profili T CONNECTION PROFILE	Profil Kodu Profile Code	(kg/mt) Weight
	1139	0,239

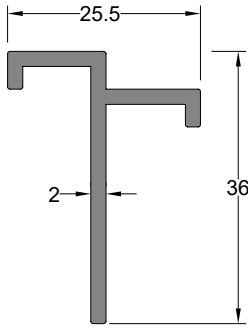

T Bağlantı Profili T CONNECTION PROFILE	Profil Kodu Profile Code	(kg/mt) Weight
	1123	0,355

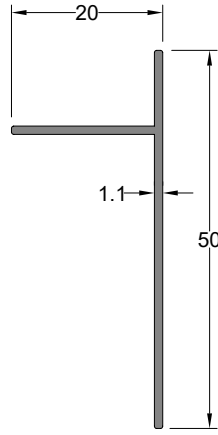

T Bağlantı Profili T CONNECTION PROFILE	Profil Kodu Profile Code	(kg/mt) Weight
	5788	0,205

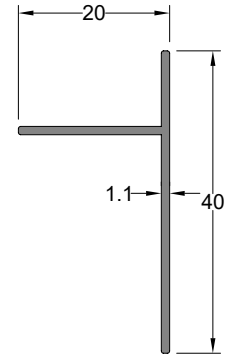

T Bağlantı Profili T CONNECTION PROFILE	Profil Kodu Profile Code	(kg/mt) Weight
	6414	0,175

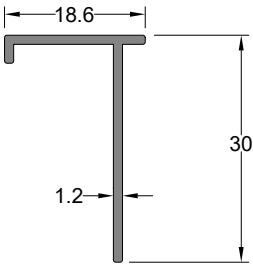

T Bağlantı Profili T CONNECTION PROFILE	Profil Kodu Profile Code	(kg/mt) Weight
	3917	0,162

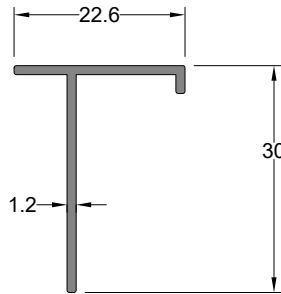

T Bağlantı Profili T CONNECTION PROFILE	Profil Kodu Profile Code	(kg/mt) Weight
	3832	0,175

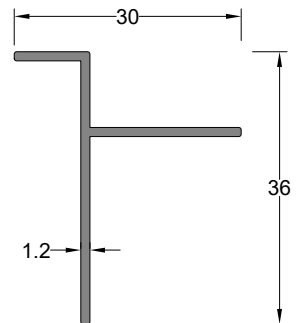

T Bağlantı Profili T CONNECTION PROFILE	Profil Kodu Profile Code	(kg/mt) Weight
	3818	0,210



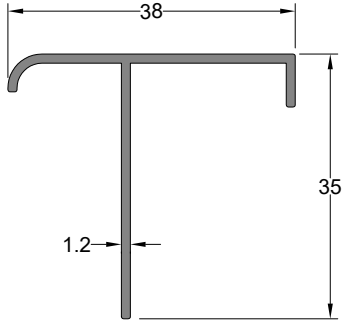

T Bağlantı Profili	Profil Kodu	(kg/mt)
T CONNECTION PROFILE	Profile Code	Weight
	7039	0,260

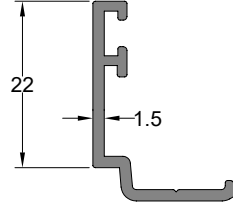

Pervaz Profili	Profil Kodu	(kg/mt)
SILL PROFILE	Profile Code	weight
	1912	0,211

1905,1906,1907,1908,1909,1910 profiller ile çalışır

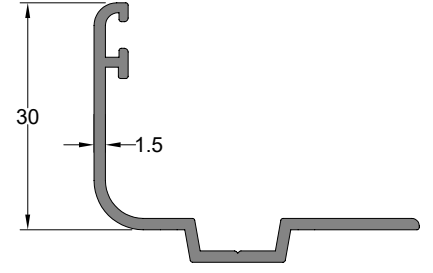

Pervaz Profili	Profil Kodu	(kg/mt)
SILL PROFILE	Profile Code	weight
	1681	0,340

1905,1906,1907,1908,1909,1910 profiller ile çalışır

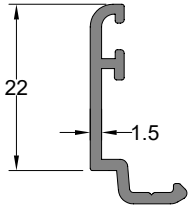

Pervaz Profili	Profil Kodu	(kg/mt)
SILL PROFILE	Profile Code	weight
	4251	0,182

1685-1686-1687-1780-1781-1782 profiller ile çalışır

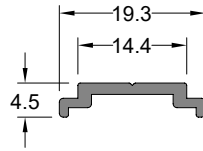

Tij Profili	Profil Kodu	(kg/mt)
STEM BAR PROFILE	Profile Code	Weight
	8241	0,099

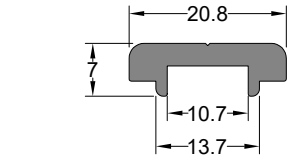

Tij Profili	Profil Kodu	(kg/mt)
STEM BAR PROFILE	Profile Code	Weight
	1755	0,234

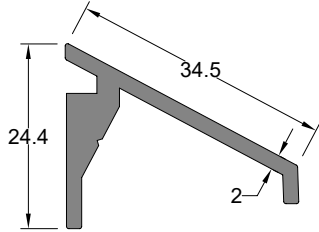

Damlalık Profili	Profil Kodu	(kg/mt)
SILL PROFILE	Profile Code	Weight
	1011	0,402

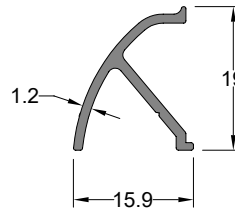

Damlalık Profili	Profil Kodu	(kg/mt)
SILL PROFILE	Profile Code	Weight
	7021	0,140

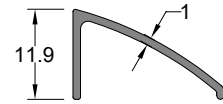

Damlalık Profili	Profil Kodu	(kg/mt)
SILL PROFILE	Profile Code	Weight
	4242	0,094

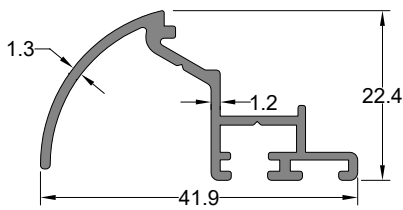

Damlalık Profili	Profil Kodu	(kg/mt)
SILL PROFILE	Profile Code	weight
	12375	0,326

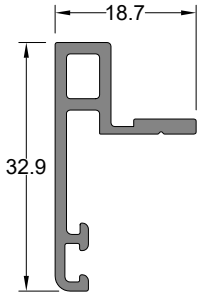

Kanat Altı Kapama Profili	Profil Kodu	(kg/mt)
SUB-SASH COVER PROFILE	Profile Code	Weight
	10923	0,295

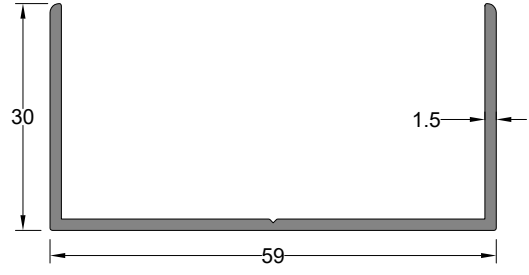

Duvar Adaptör Profili	Profil Kodu	(kg/mt)
WALL ADAPTER PROFILE	Profile Code	Weight
	12371	0,469

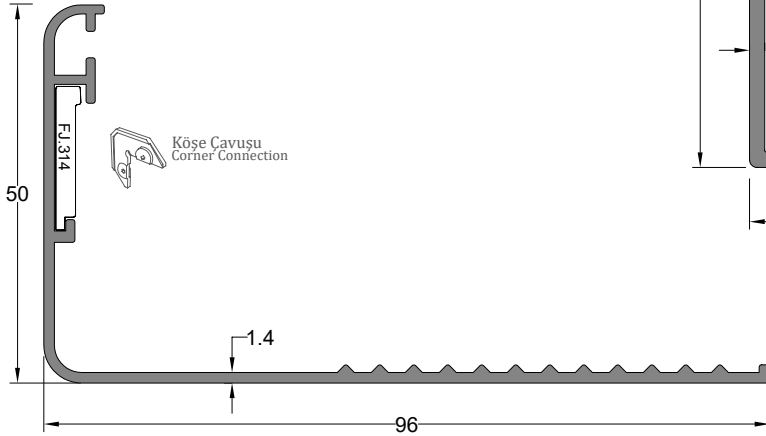

Pervaz Profili	Profil Kodu	(kg/mt)
SILL PROFILE	Profile Code	Weight
	553	0,656

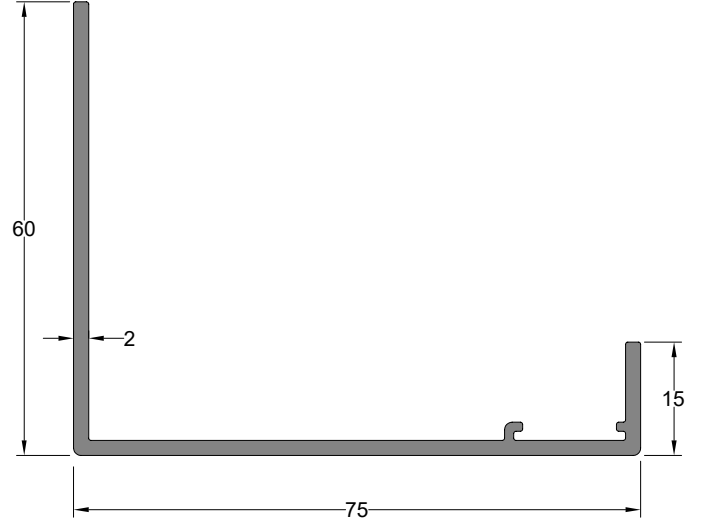

Pervaz Profili	Profil Kodu	(kg/mt)
SILL PROFILE	Profile Code	Weight
	10012	0,805

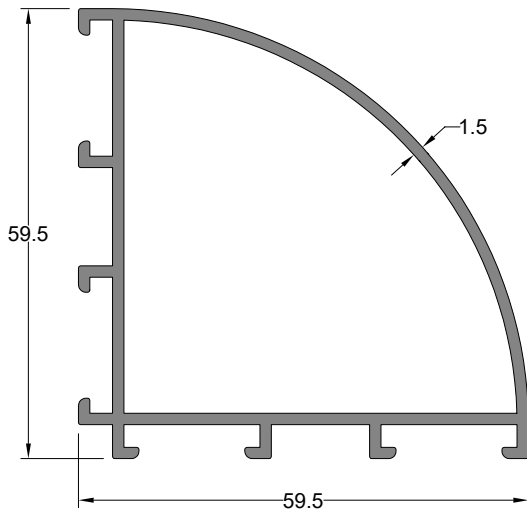

Köşe Dönüş Profili	Profil Kodu	(kg/mt)
CORNER PROFILE	Profile Code	Weight
	11822	0,981

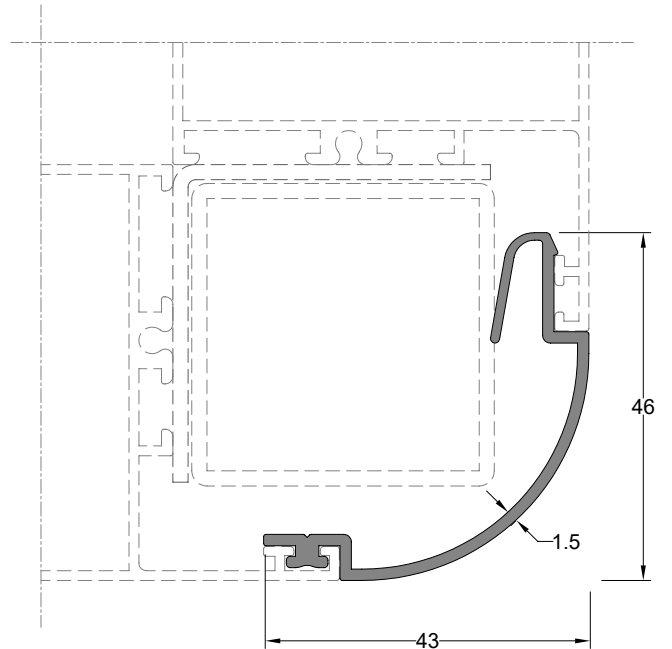

Köşe Kapak Profili	Profil Kodu	(kg/mt)
CORNER COVER PROFILE	Profile Code	Weight
	1911	0,426

\*\* Her profil için minimum sipariş 300 kg'dır.  
\*\* Minimum order quantity is 300 kg per profile.

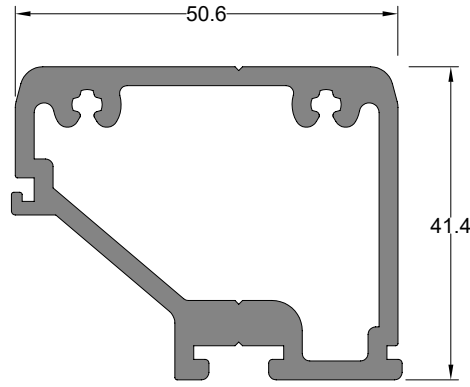

Orta Kayıt Bağlantı Profili MULLION CONNECTION PROFILE	Profil Kodu Profile Code	(kg/mt) weight
	1775	1,525

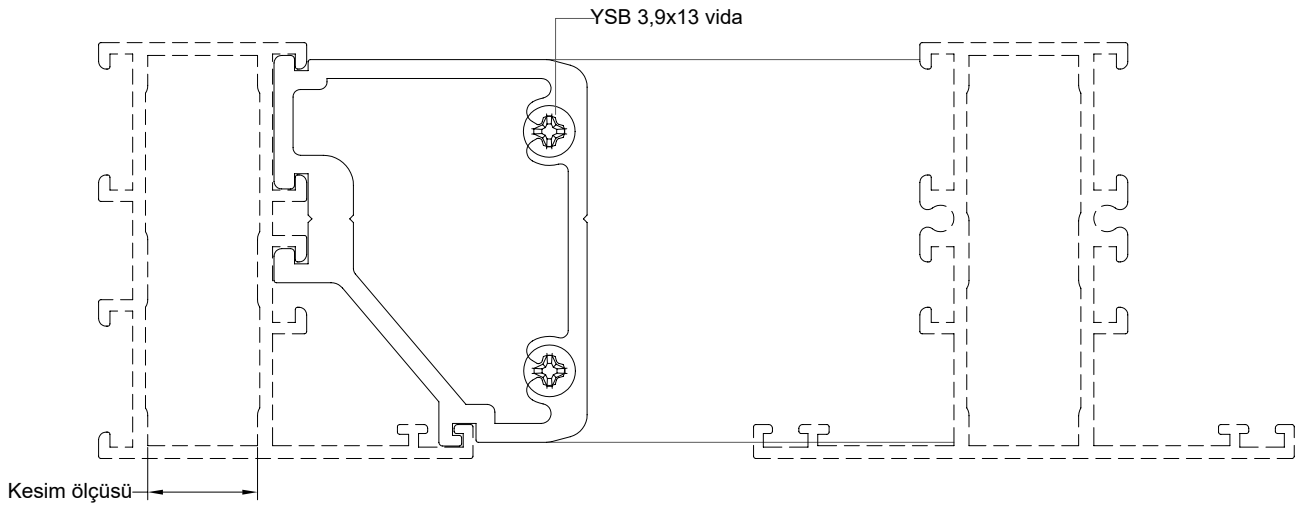

Orta Kayıt Bağlantı Profil Kodu Mullion Connection Profile Code	Stok Kodu Reference Code	Kullanıldığı Profil Compatible Profile	Kesim Boyu (mm) Cutting Length (mm)
1775	OKB-1775-140	1790	14,00 mm
	OKB-1775-155	1693	15,50 mm
	OKB-1775-220	5156	22,00 mm
	OKB-1775-285	11960	28,50 mm
	OKB-1775-285	2096	28,50 mm
	OKB-1775-285	3541	28,50 mm
	OKB-1775-285	1783	28,50 mm
	OKB-1775-300	1694	30,00 mm
	OKB-1775-410	1901	41,00 mm
	OKB-1775-465	5520	46,50 mm
	OKB-1775-723	4687	72,30 mm
	OKB-1775-725	1788	72,50 mm

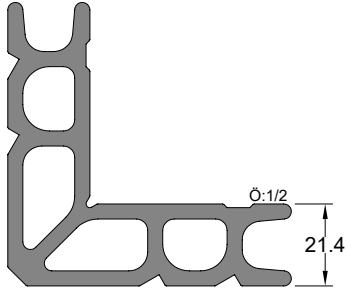

Köşe Takoz Profili CORNER WEDGE PROFILE	Profil Kodu Profile Code	(kg/mt) weight
	1661	3,629

Köşe Takozu Profil Kodu Corner Wedge Profile Code	Kullanıldığı Profil Compatible Profile	Kesim Boyu (mm) Cutting Length (mm)
1661	5580	51,10 mm
	5156	50,90 mm
	12059	51,70 mm

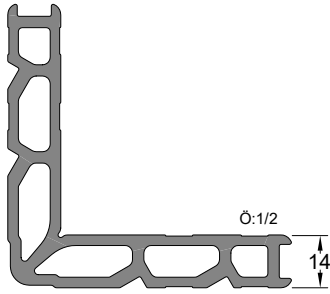

Köşe Takoz Profili CORNER WEDGE PROFILE	Profil Kodu Profile Code	(kg/mt) weight
	1662	2,576

Köşe Takozu Profil Kodu Corner Wedge Profile Code	Kullanıldığı Profil Compatible Profile	Kesim Boyu (mm) Cutting Length (mm)
1662	1780	56,10 mm
	1906	51,10 mm
	1784	51,10 mm
	1790	51,10 mm

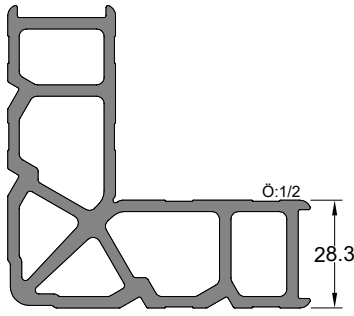

Köşe Takoz Profili CORNER WEDGE PROFILE	Profil Kodu Profile Code	(kg/mt) weight
	1663	3,526

Köşe Takozu Profil Kodu Corner Wedge Profile Code	Kullanıldığı Profil Compatible Profile	Kesim Boyu (mm) Cutting Length (mm)
1663	1785,2096, 1783	50,50 mm
	1908	50,50 mm
	3540, 3541	50,90 mm
	1781	56,10 mm
	11959	51,50 mm
	11960	51,50 mm

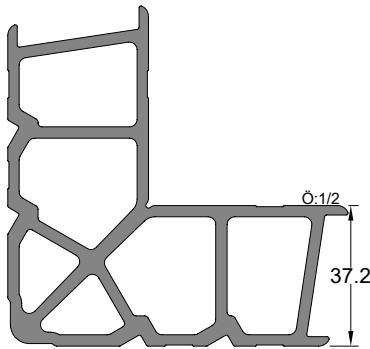

Köşe Takoz Profili CORNER WEDGE PROFILE	Profil Kodu Profile Code	(kg/mt) weight
	1664	3,991

Köşe Takozu Profil Kodu Corner Wedge Profile Code	Kullanıldığı Profil Compatible Profile	Kesim Boyu (mm) Cutting Length (mm)
1664	1910	50,50 mm
	5157	51,70 mm
	5158	51,70 mm
	1782	56,10 mm

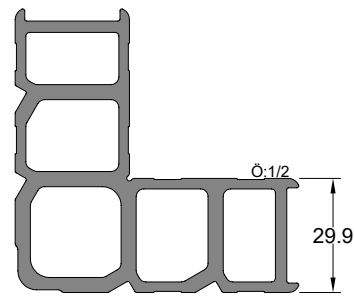

Köşe Takoz Profili CORNER WEDGE PROFILE	Profil Kodu Profile Code	(kg/mt) weight
	1696	3,340

Köşe Takozu Profil Kodu Corner Wedge Profile Code	Kullanıldığı Profil Compatible Profile	Kesim Boyu (mm) Cutting Length (mm)
1696	3545	51,90 mm
	1692	51,90 mm
	1694	51,90 mm
	1907	51,90 mm
	1686	57,00 mm

\*\* Her profil için minimum sipariş 300 kg'dır.  
\*\* Minimum order quantity is 300 kg per profile.

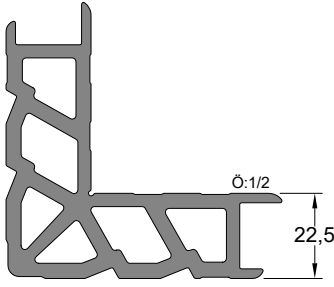

Köşe Takoz Profili CORNER WEDGE PROFILE	Profil Kodu Profile Code	(kg/mt) weight
	3088	3,498

Köşe Takozu Profil Kodu Corner Wedge Profile Code	Kullanıldığı Profil Compatible Profile	Kesim Boyu (mm) Cutting Length (mm)
3088	12229	56,80 mm

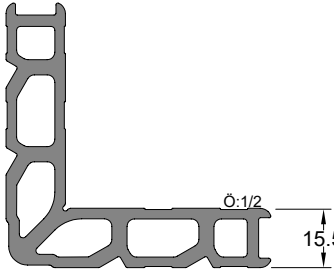

Köşe Takoz Profili CORNER WEDGE PROFILE	Profil Kodu Profile Code	(kg/mt) weight
	1695	2,540

Köşe Takozu Profil Kodu Corner Wedge Profile Code	Kullanıldığı Profil Compatible Profile	Kesim Boyu (mm) Cutting Length (mm)
1695	1691	51,90 mm
	1905	51,90 mm
	1685	56,90 mm
	1693	51,10 mm
	12747	51,00 mm

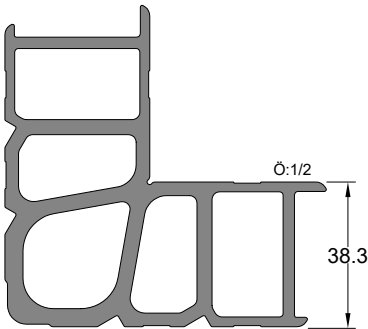

Köşe Takoz Profili CORNER WEDGE PROFILE	Profil Kodu Profile Code	(kg/mt) weight
	1697	4,212

Köşe Takozu Profil Kodu Corner Wedge Profile Code	Kullanıldığı Profil Compatible Profile	Kesim Boyu (mm) Cutting Length (mm)
1697	1909	51,80 mm
	1687	57,00 mm

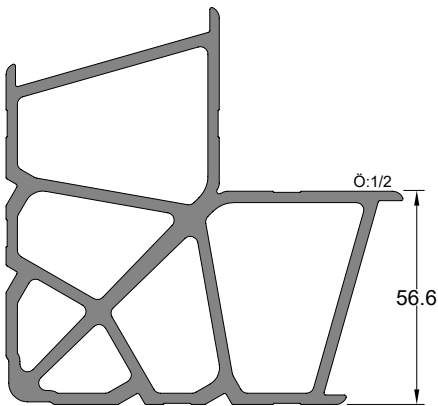

Köşe Takoz Profili CORNER WEDGE PROFILE	Profil Kodu Profile Code	(kg/mt) weight
	1398	5,085

Köşe Takozu Profil Kodu Corner Wedge Profile Code	Kullanıldığı Profil Compatible Profile	Kesim Boyu (mm) Cutting Length (mm)
1398	1786	50,50 mm
	1787	50,50 mm
	1660	51,30 mm
	3943	51,30 mm

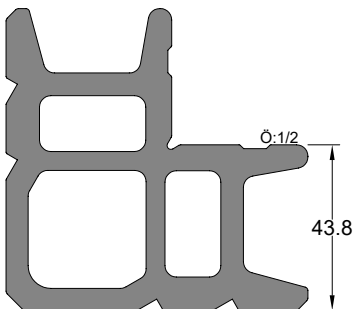

Köşe Takoz Profili CORNER WEDGE PROFILE	Profil Kodu Profile Code	(kg/mt) weight
	1903	6,162

Köşe Takozu Profil Kodu Corner Wedge Profile Code	Kullanıldığı Profil Compatible Profile	Kesim Boyu (mm) Cutting Length (mm)
1903	1900	50,80 mm

\*\* Her profil için minimum sipariş 300 kg'dır.  
\*\* Minimum order quantity is 300 kg per profile.

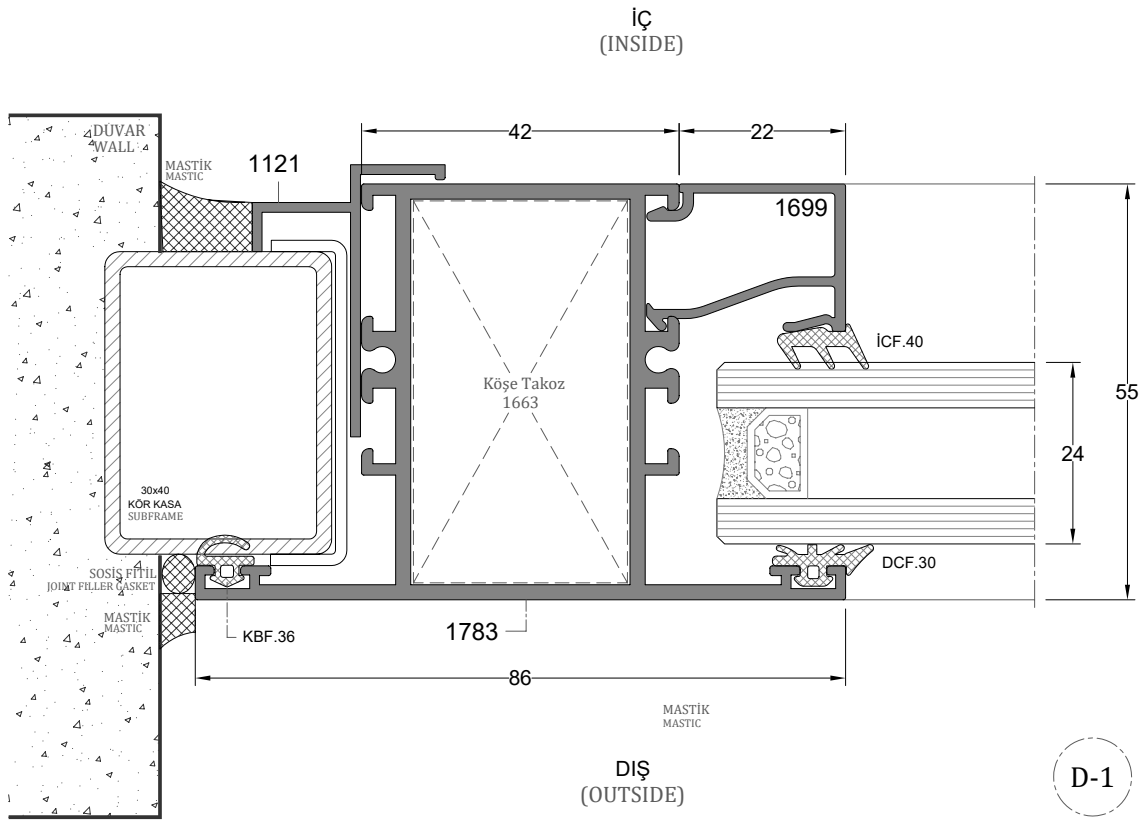
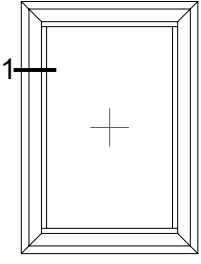

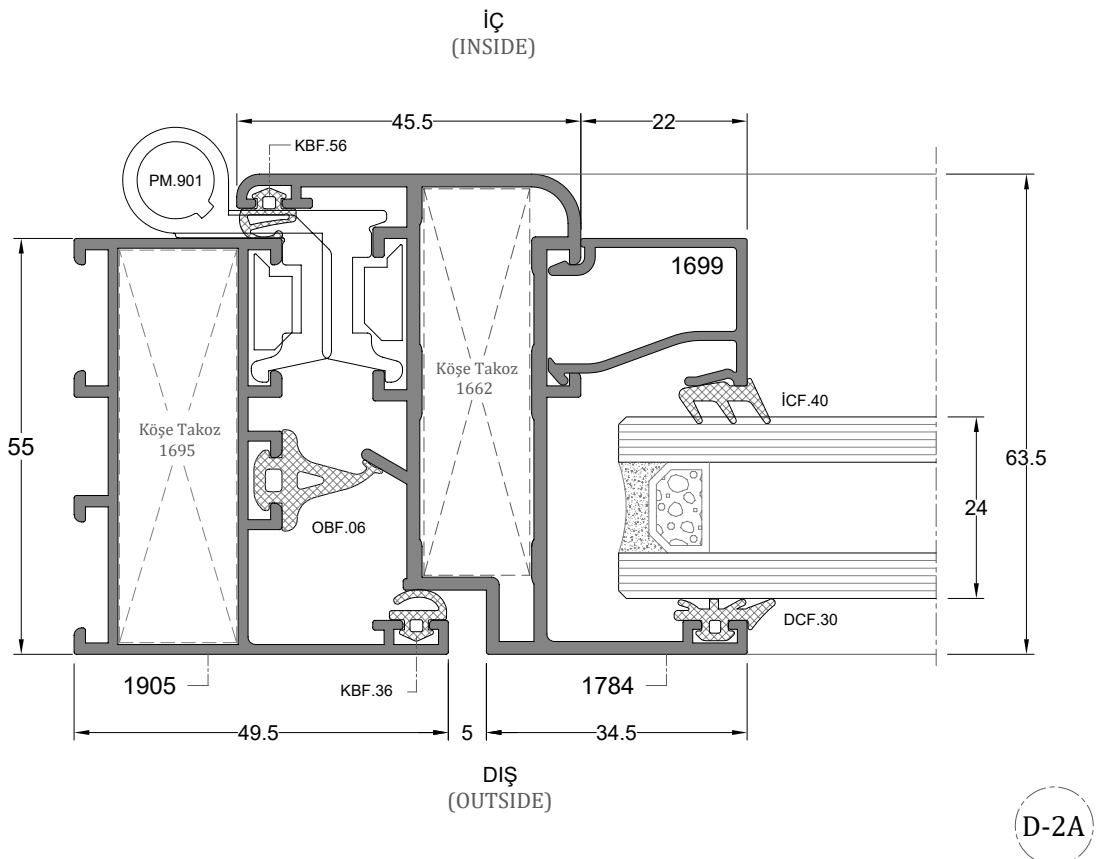
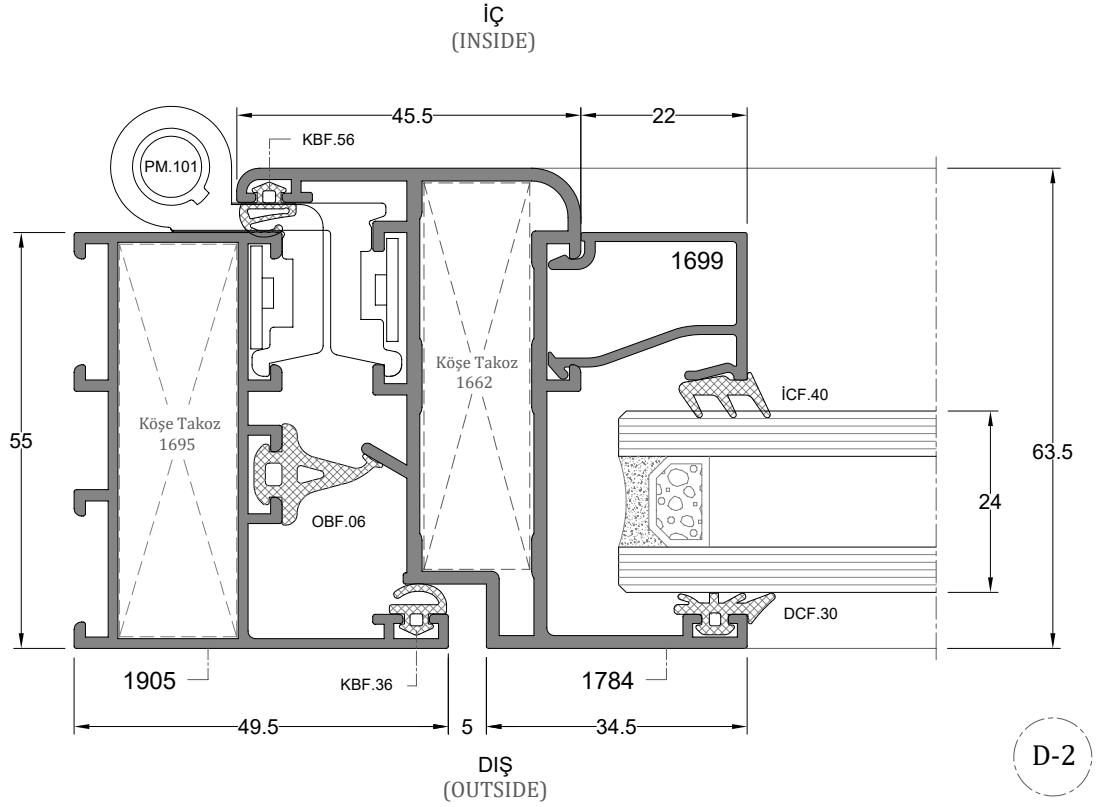
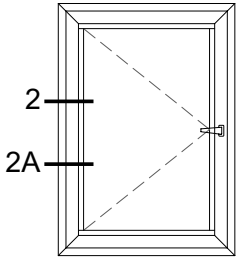

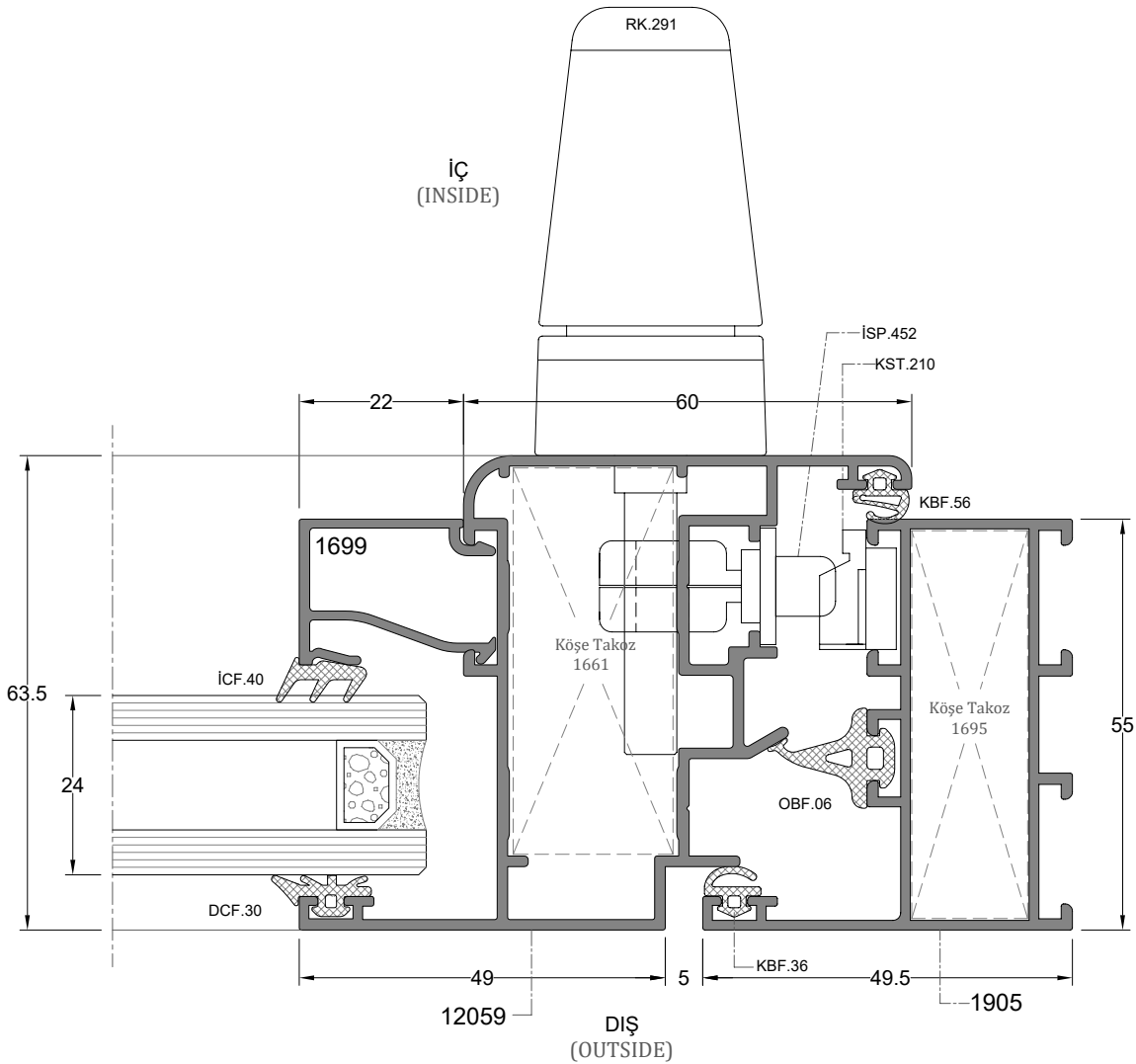
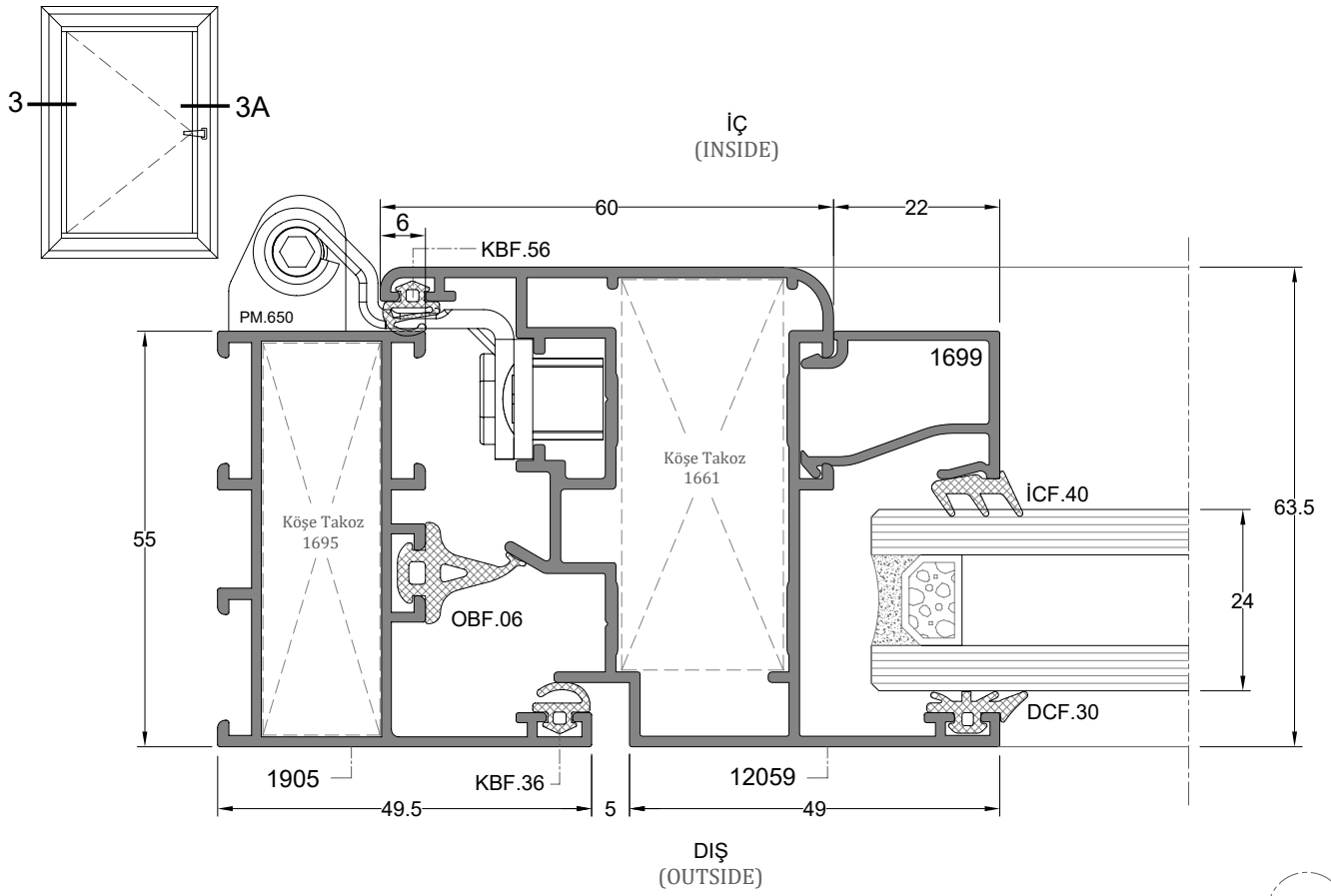



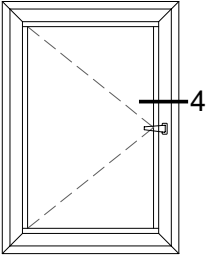

iÇ  
(INSIDE)

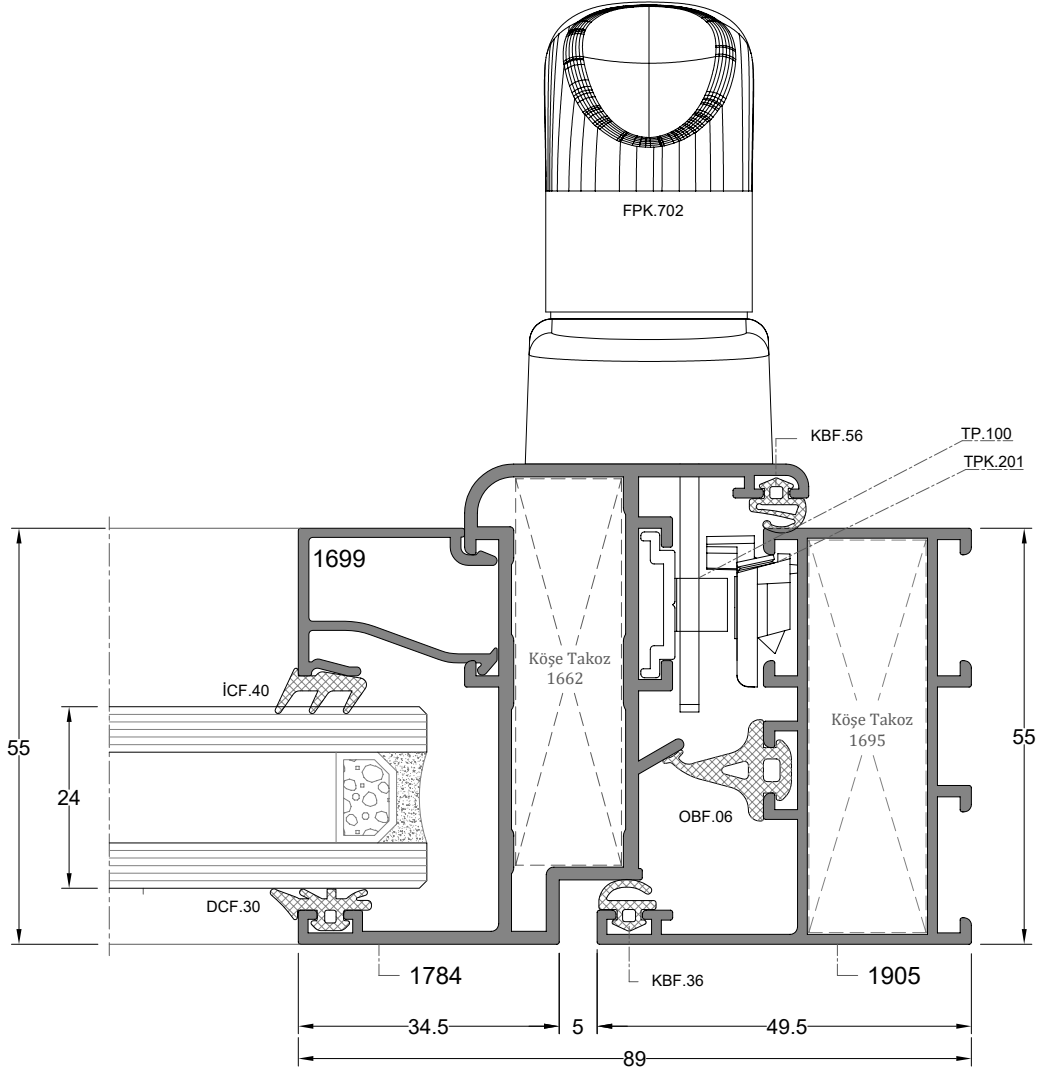

DIŞ  
(OUTSIDE)

D-4

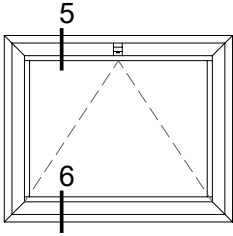

İÇ  
(INSIDE)

D-5

DIŞ  
(OUTSIDE)

D-6

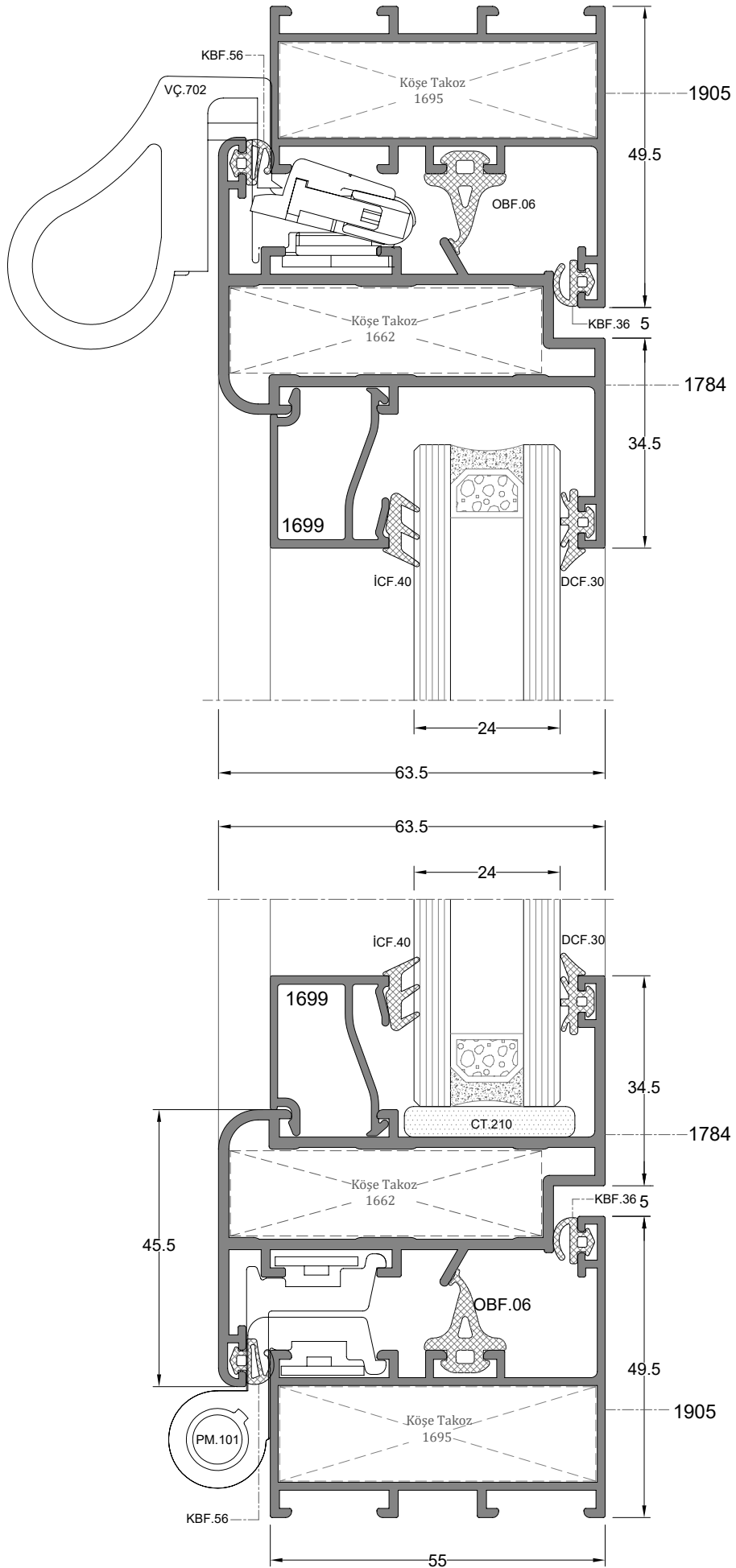

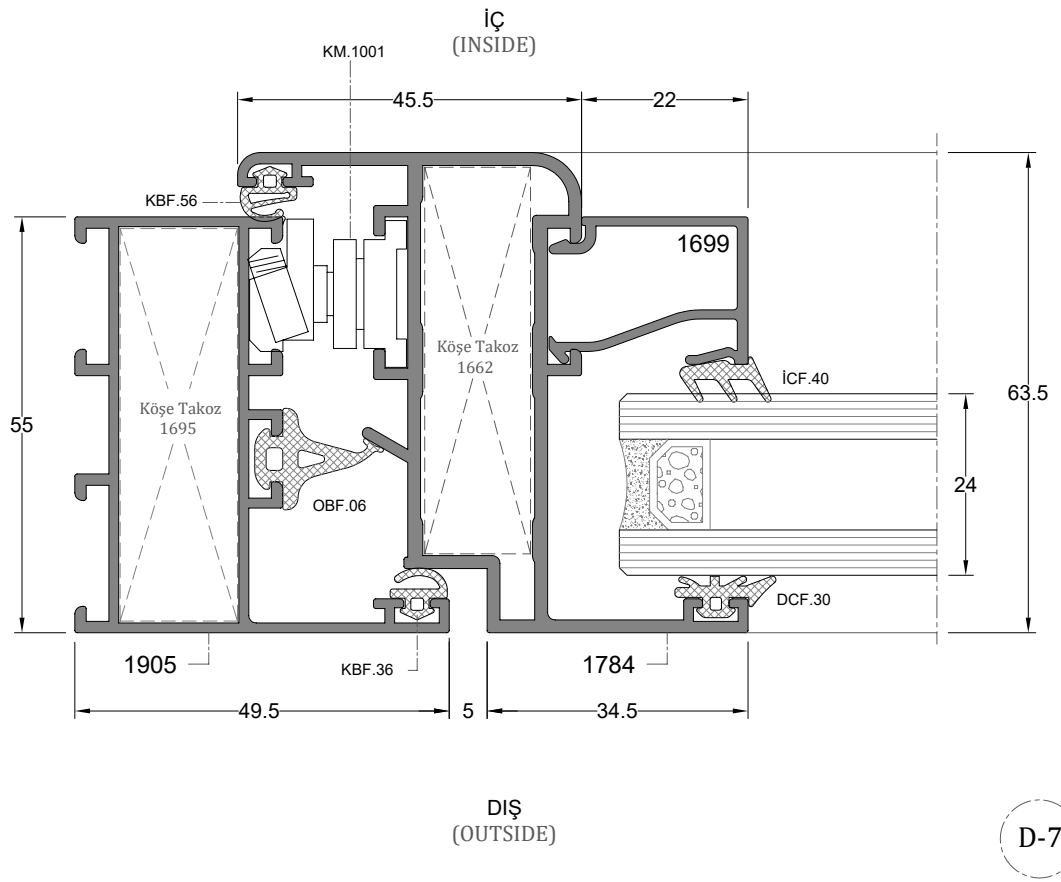
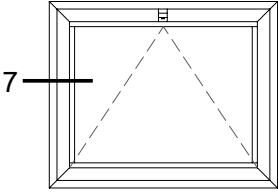

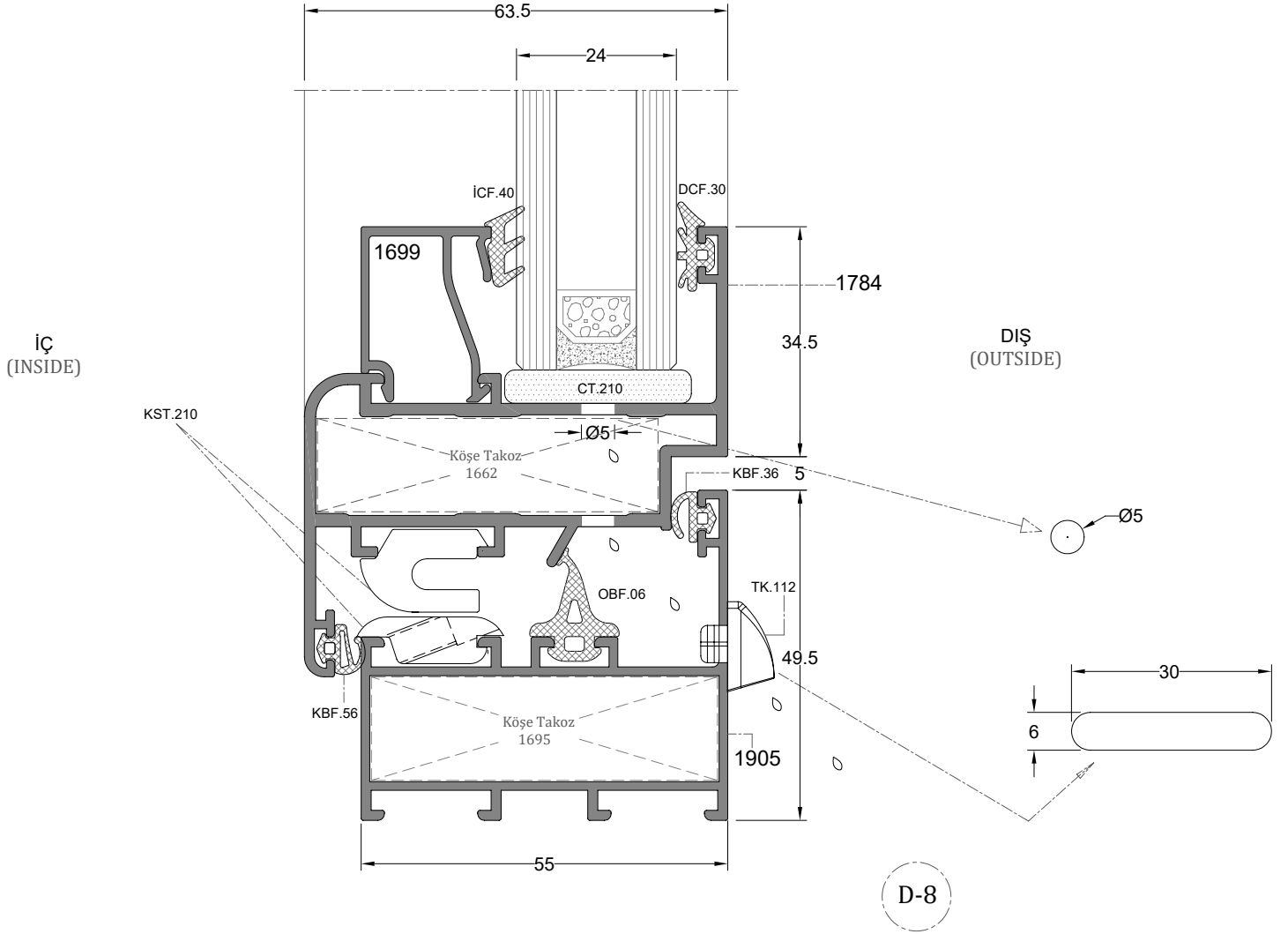
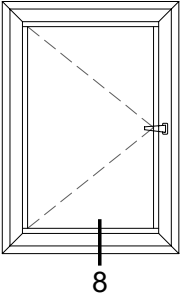

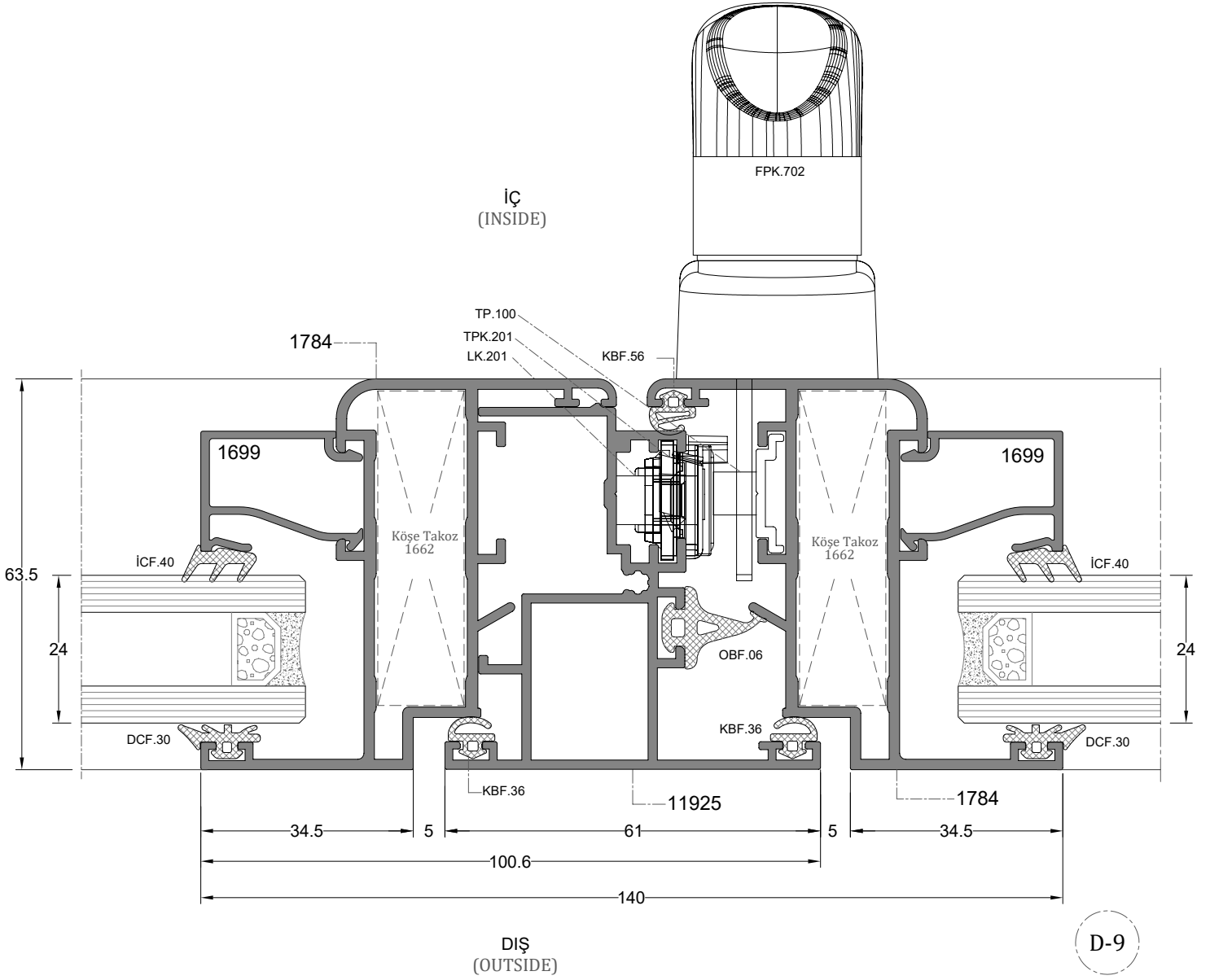
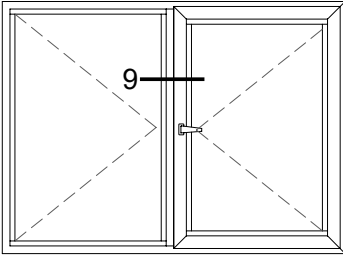

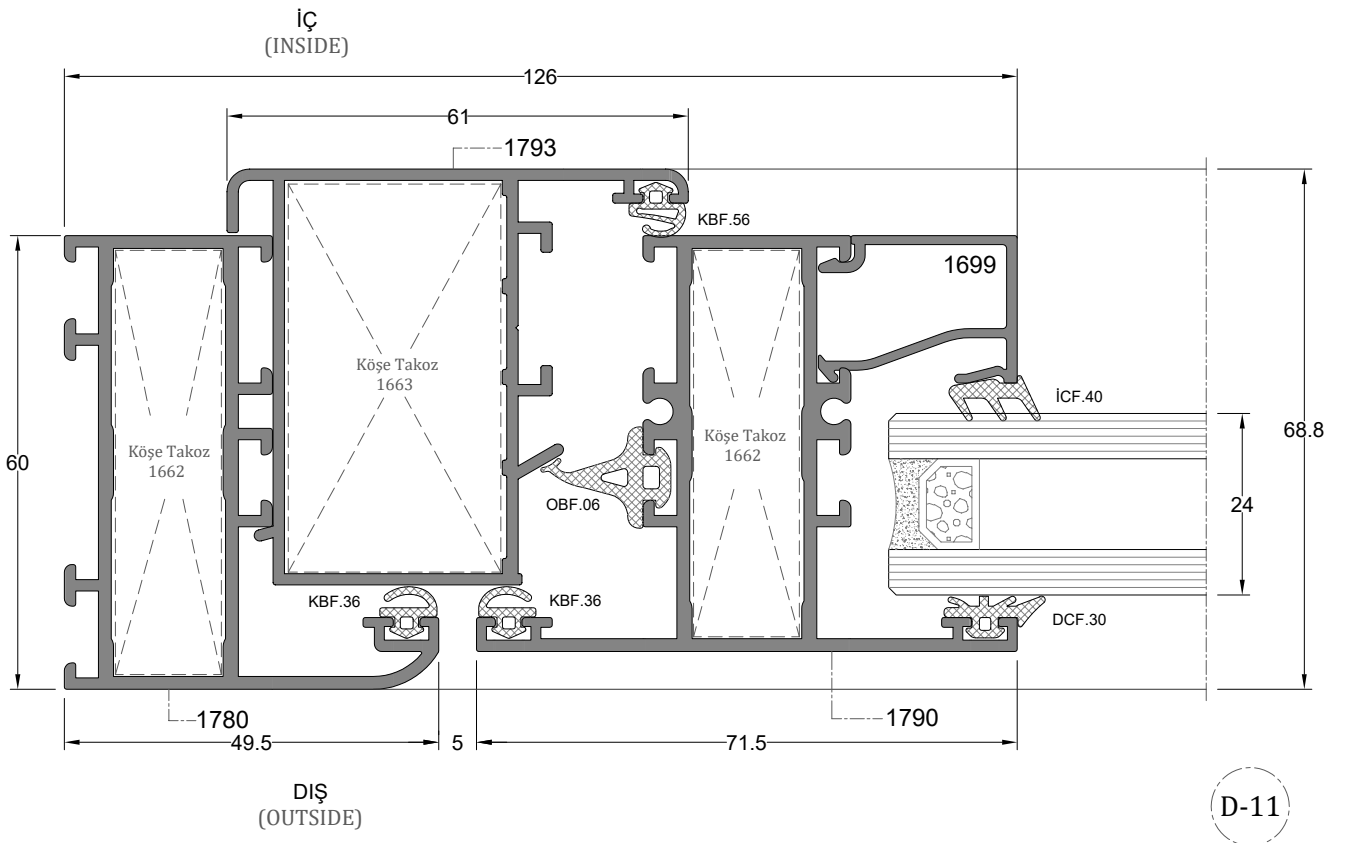
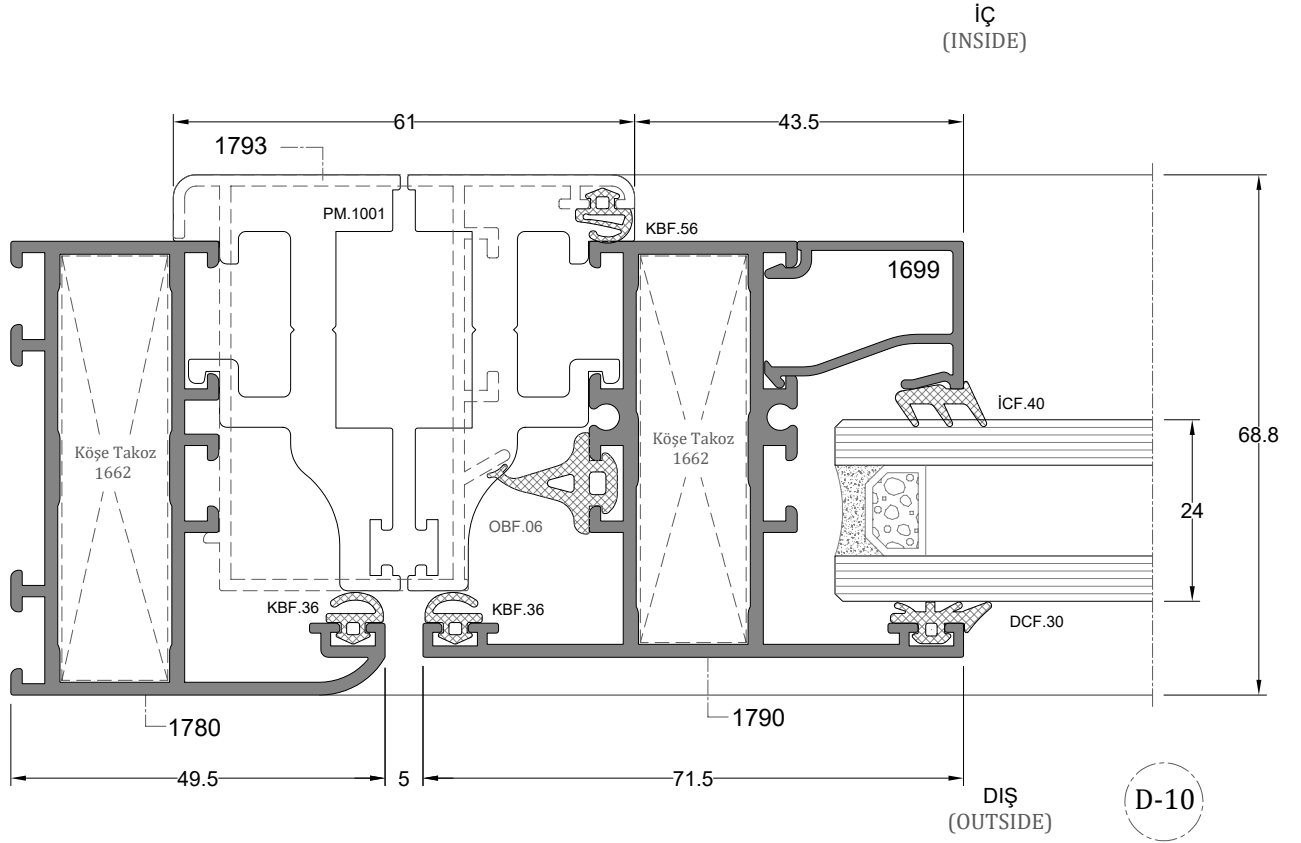
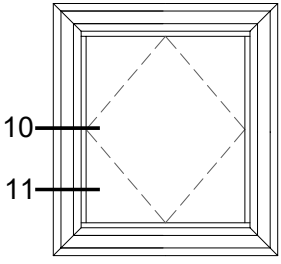

İÇ  
(INSIDE)

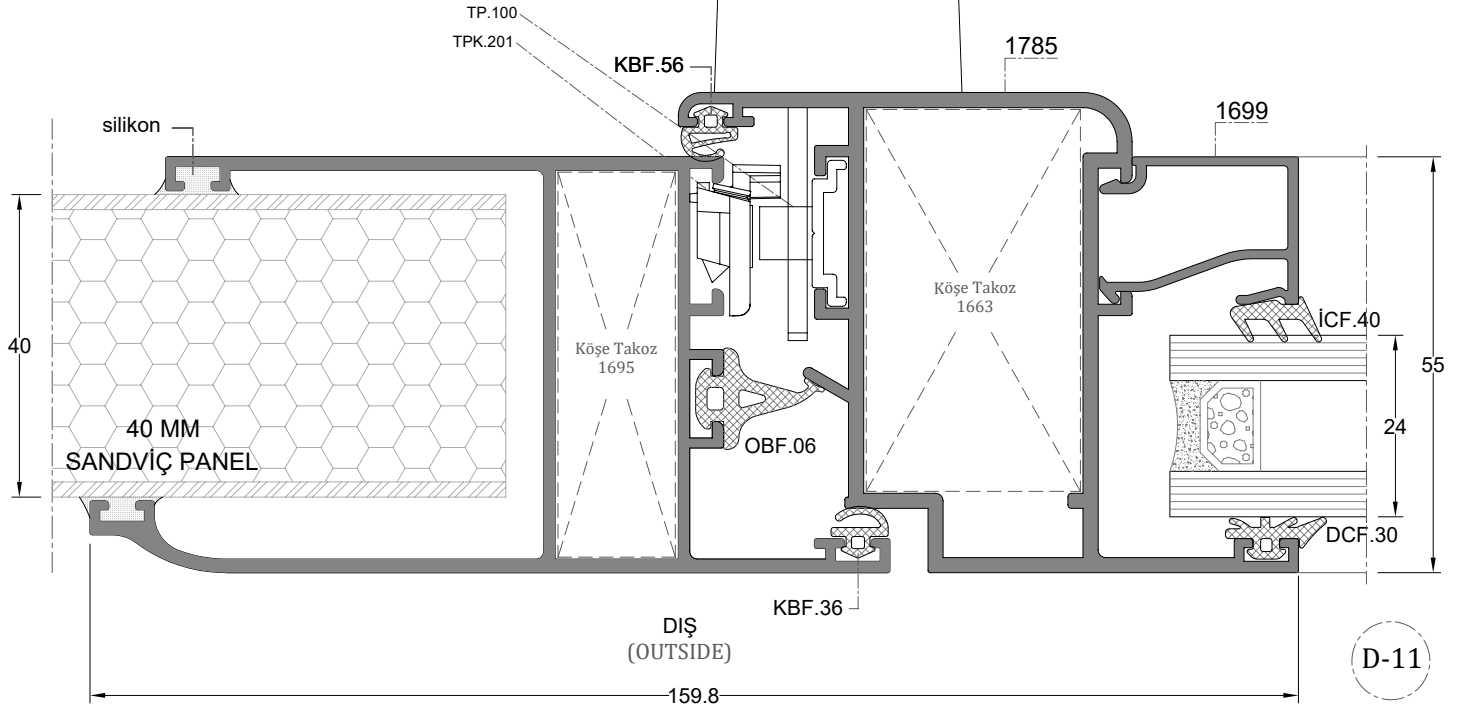
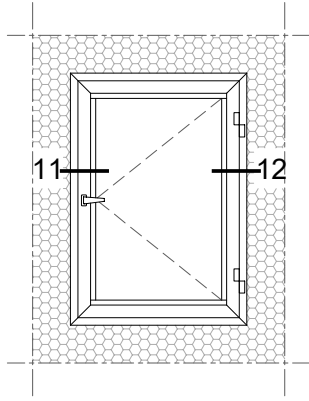

İÇ  
(INSIDE)

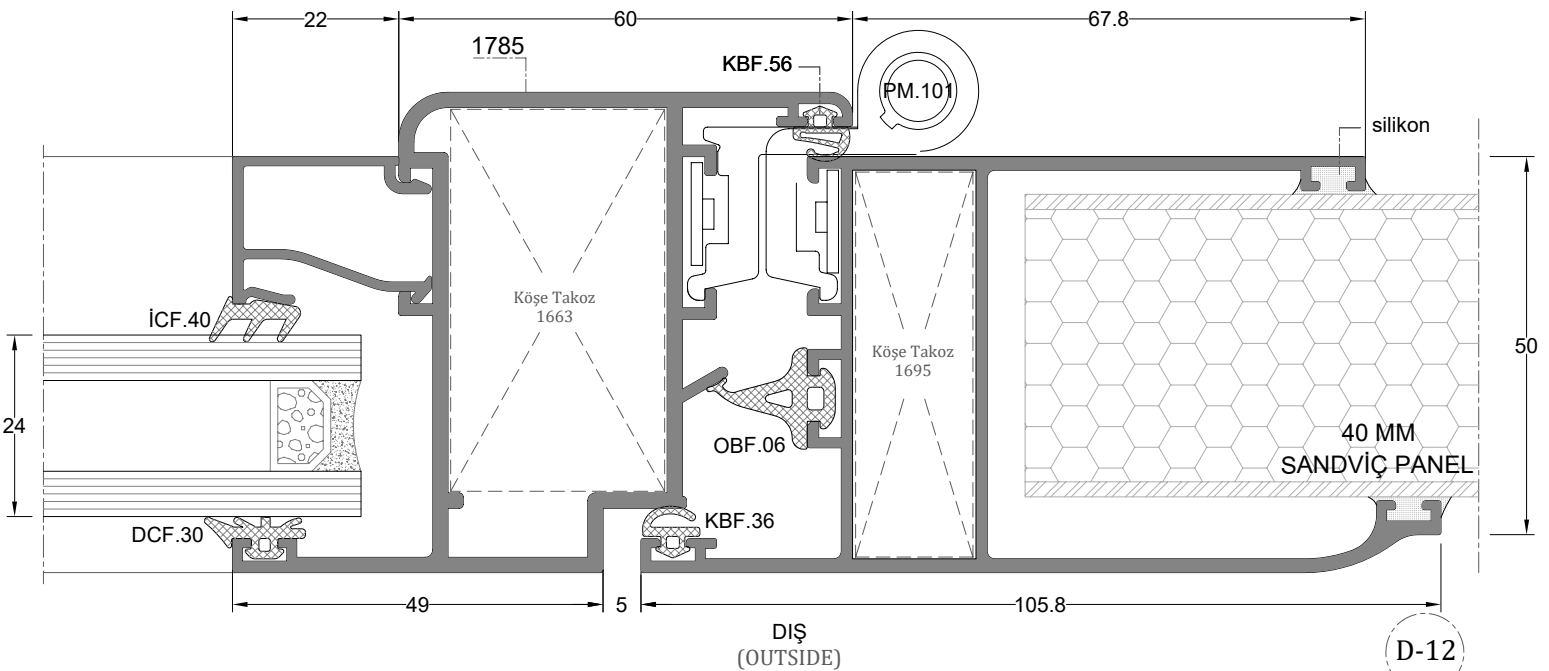

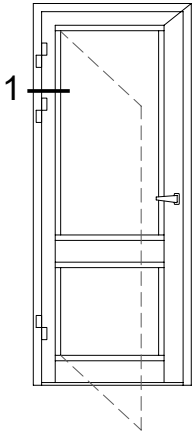

**İÇE AÇILIR BİNİLİ KAPI DETAY**  
INWARD OPENING OVERLAPPING DOOR DETAIL

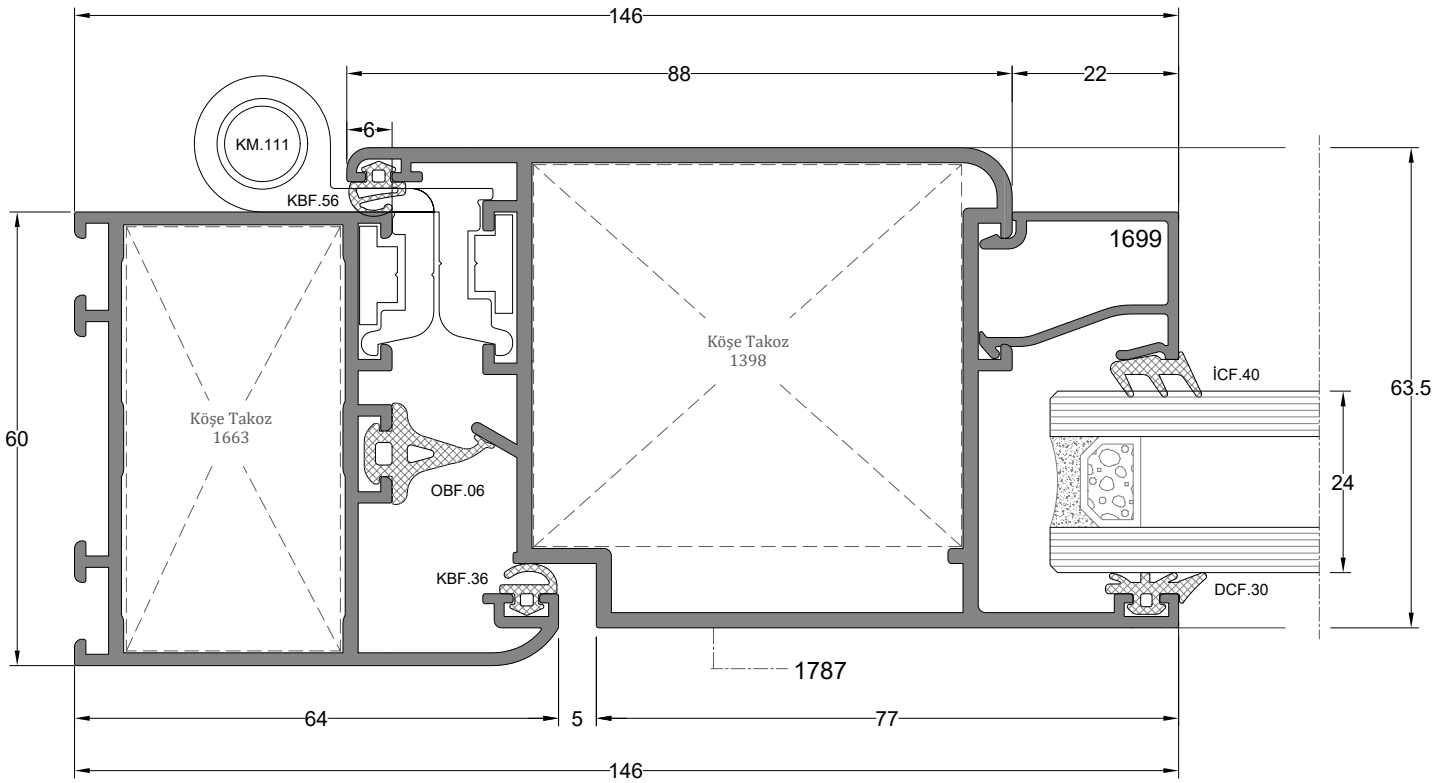

D-1



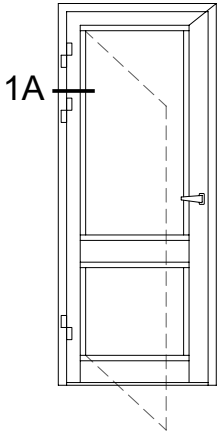

**İÇE AÇILIR BİNİLİ KAPI DETAY**  
INWARD OPENING OVERLAPPING DOOR DETAIL

İÇ  
(INSIDE)

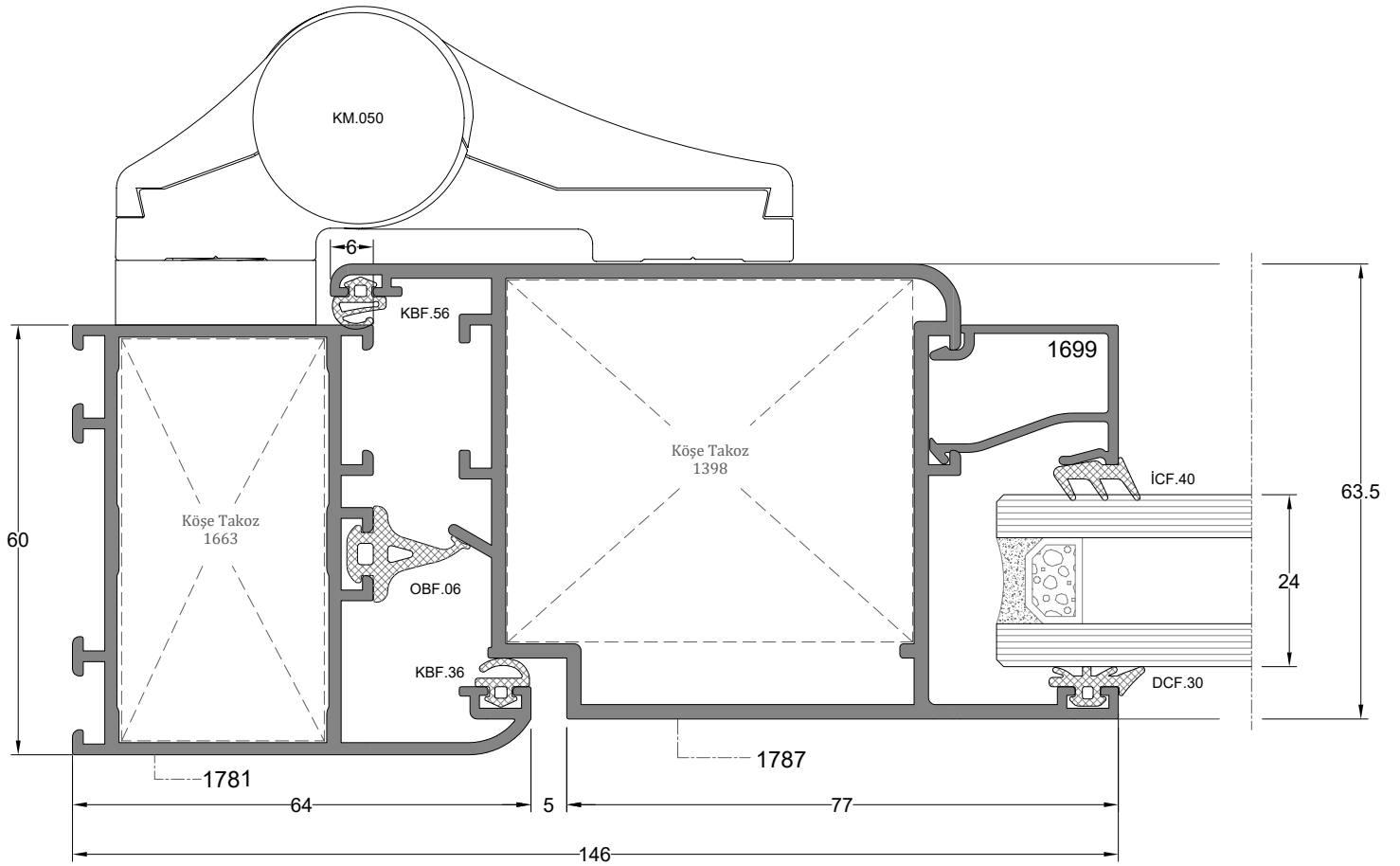

DIŞ  
(OUTSIDE)

D-1A

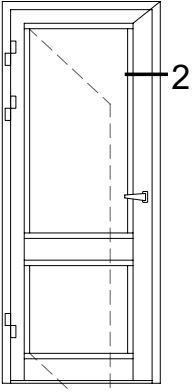

**İÇE AÇILIR BİNİLİ KAPI DETAY**  
INWARD OPENING OVERLAPPING DOOR DETAIL

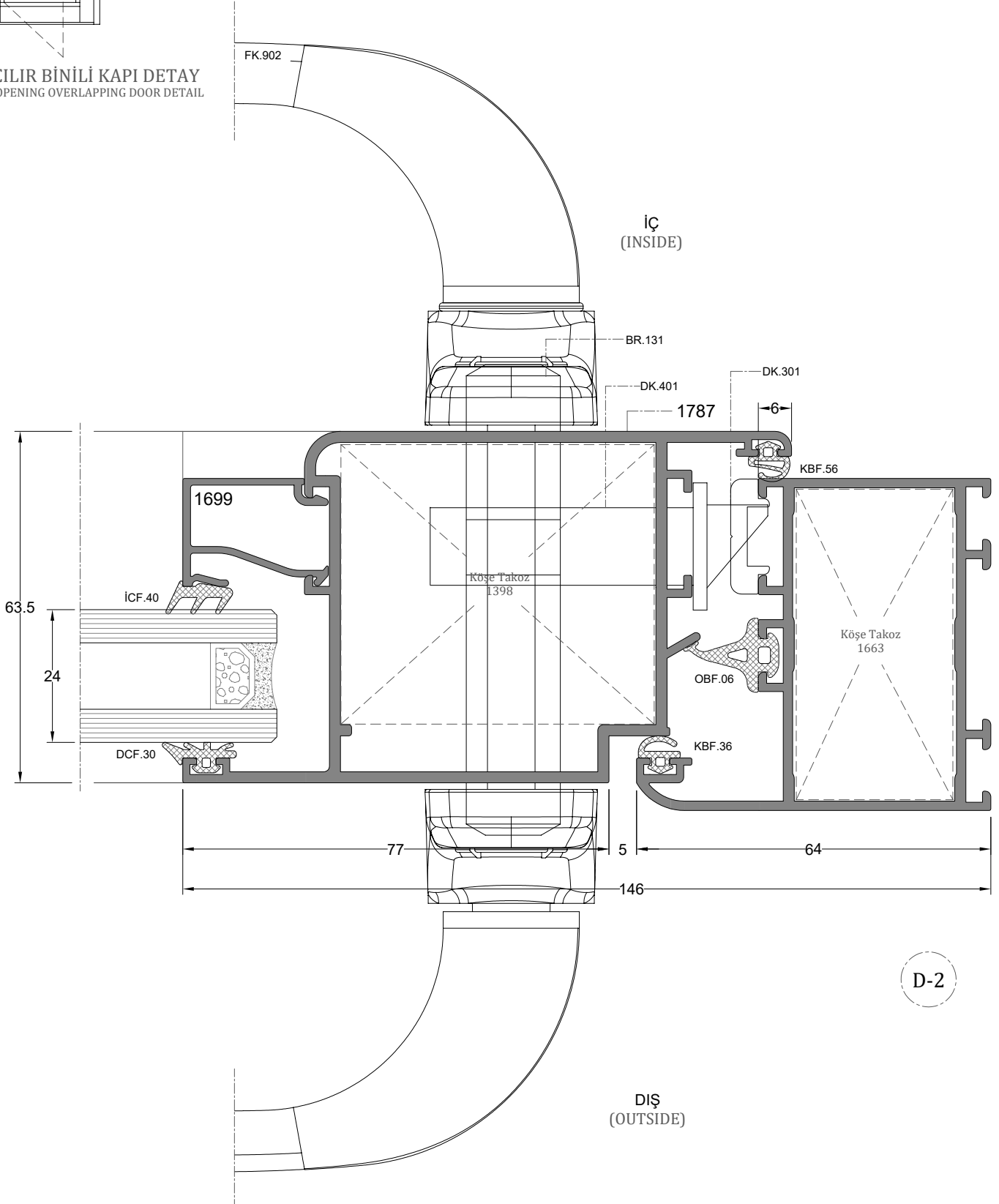

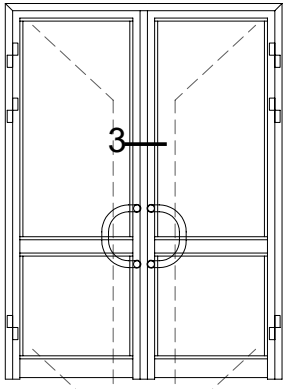

**İÇE AÇILIR ADAPTÖRLÜ BİNİLİ  
KAPI DETAY**  
INWARD OPENING OVERLAPPING DOOR DETAIL

UK.101

İÇ  
(INSIDE)

UK.101

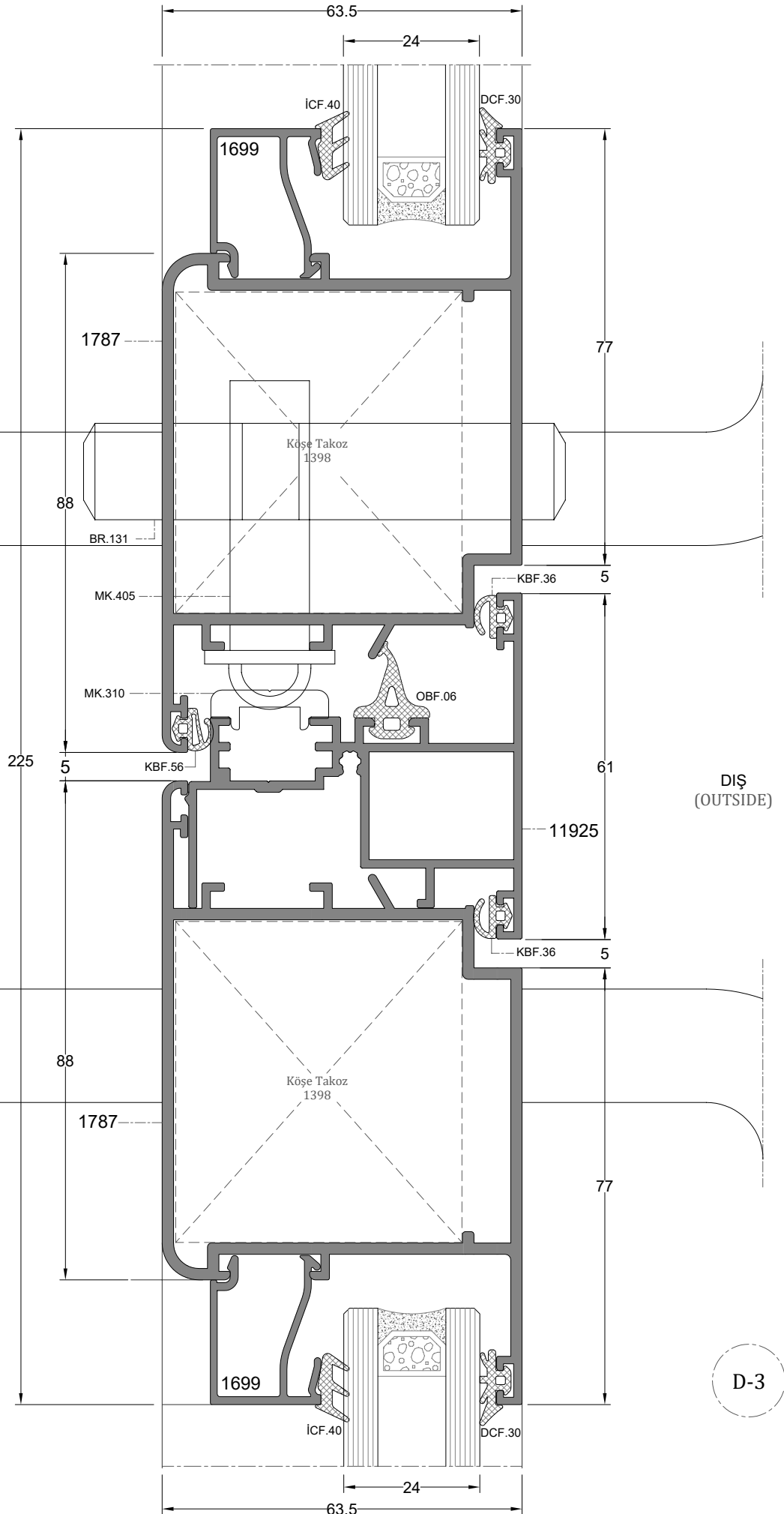

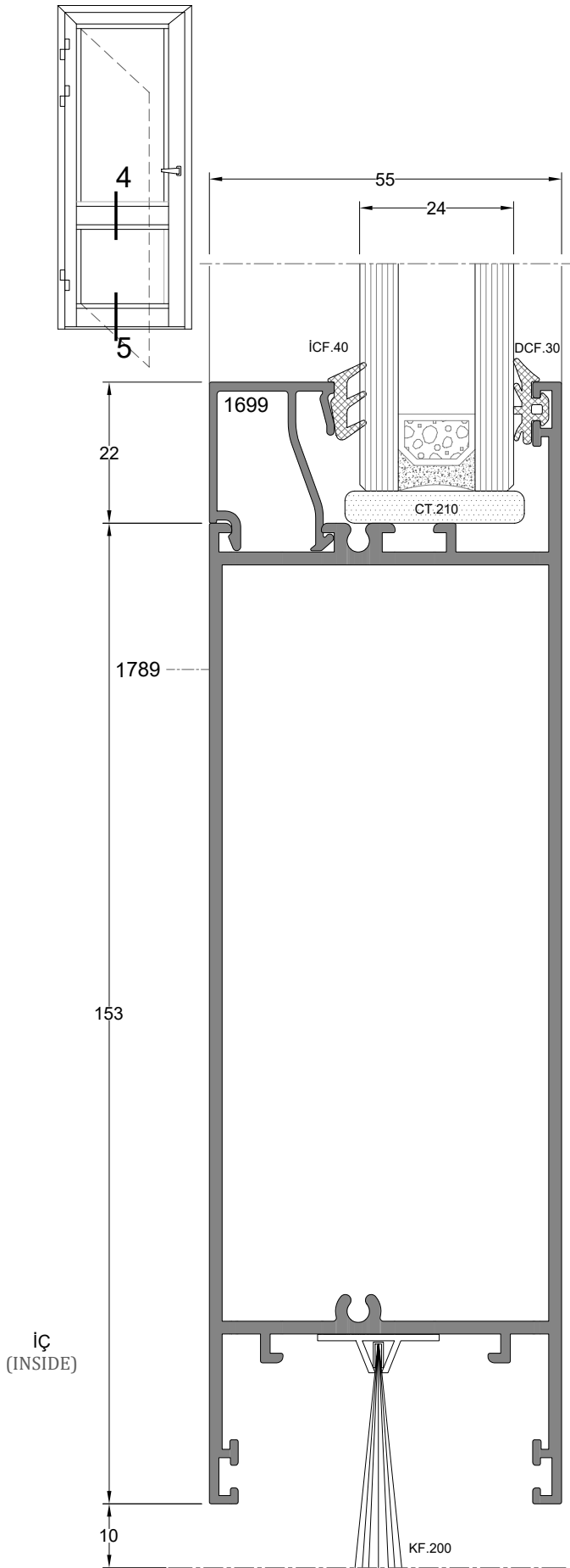

D-5

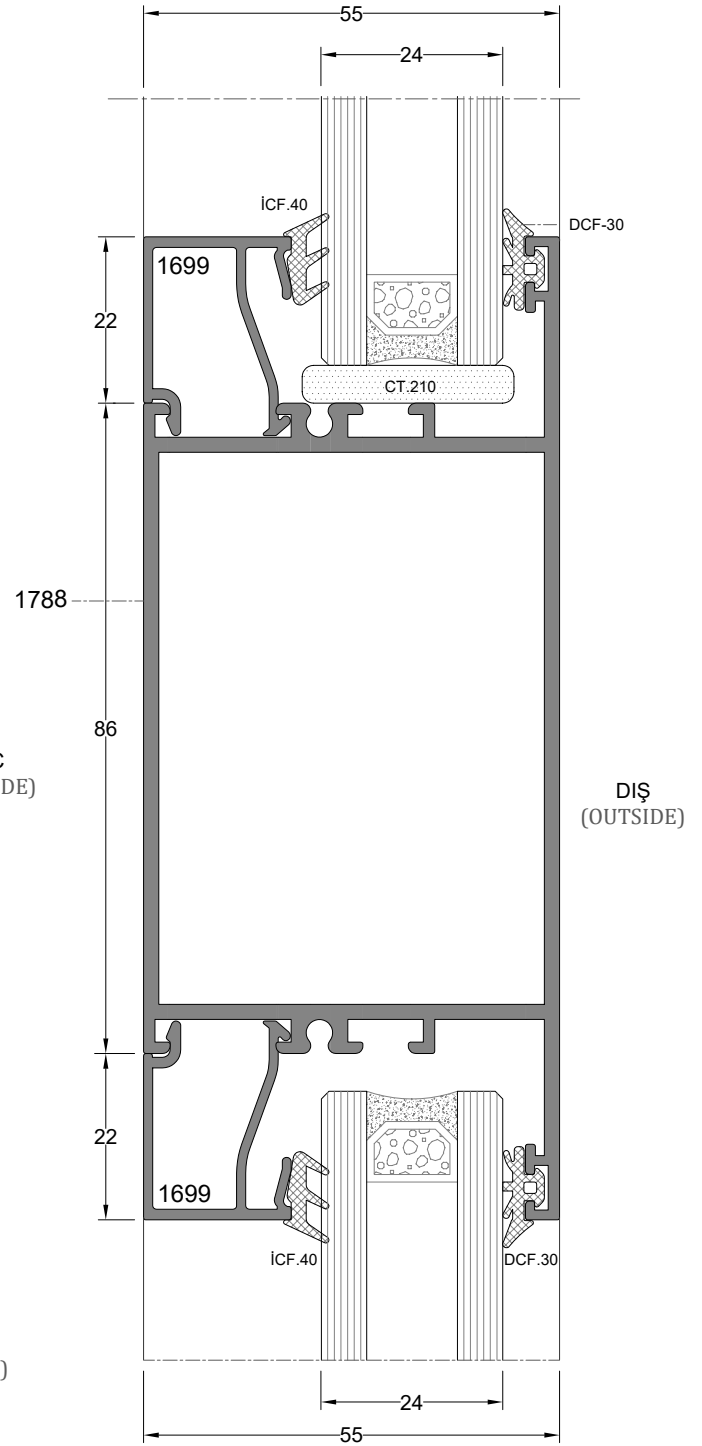

D-4

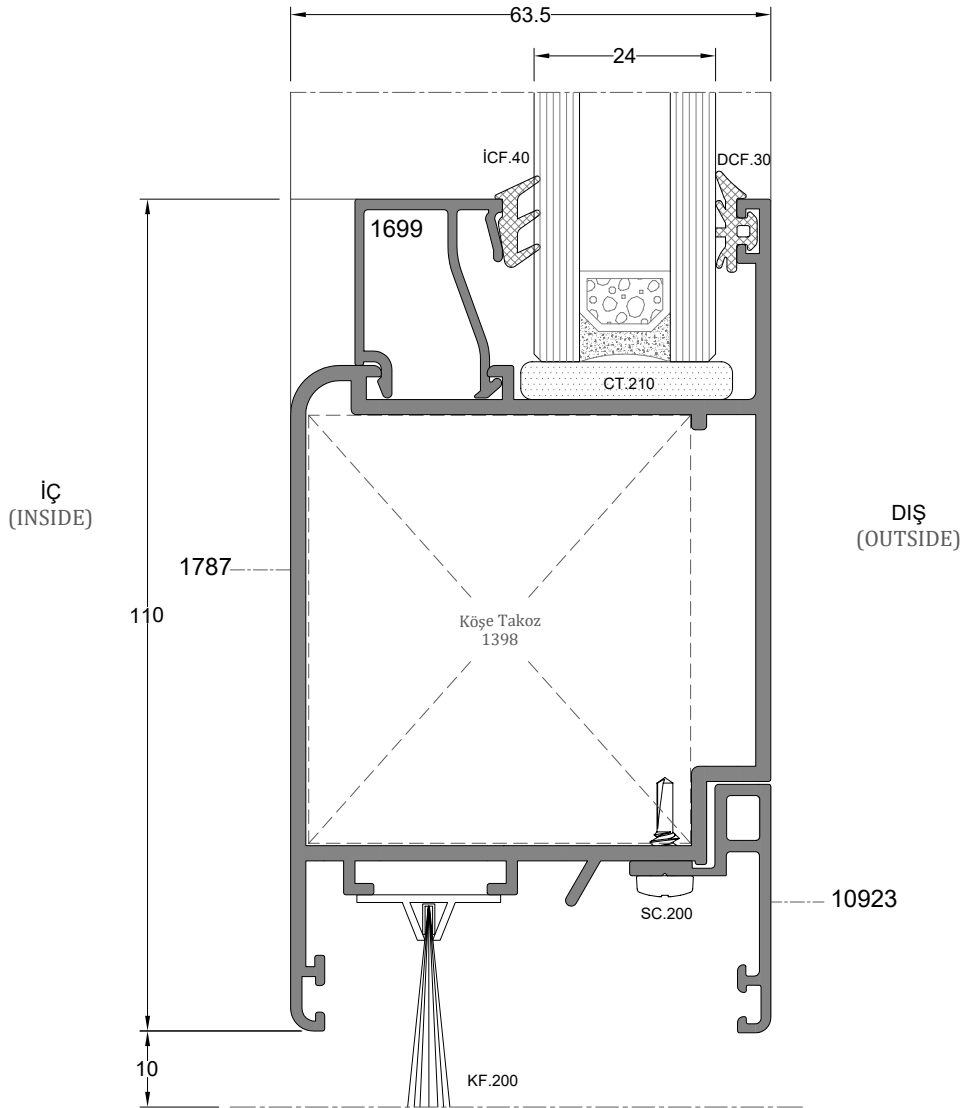
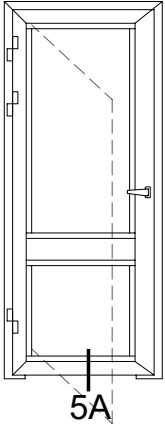

D-5A

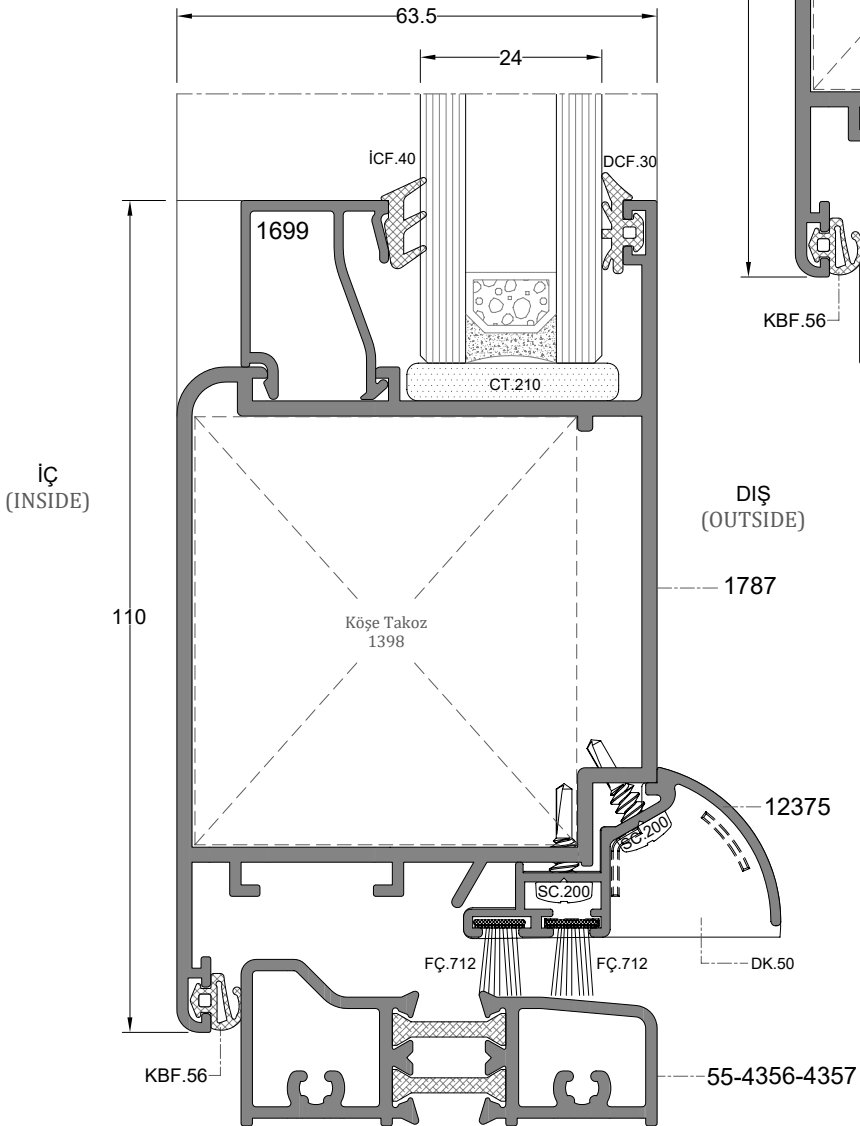
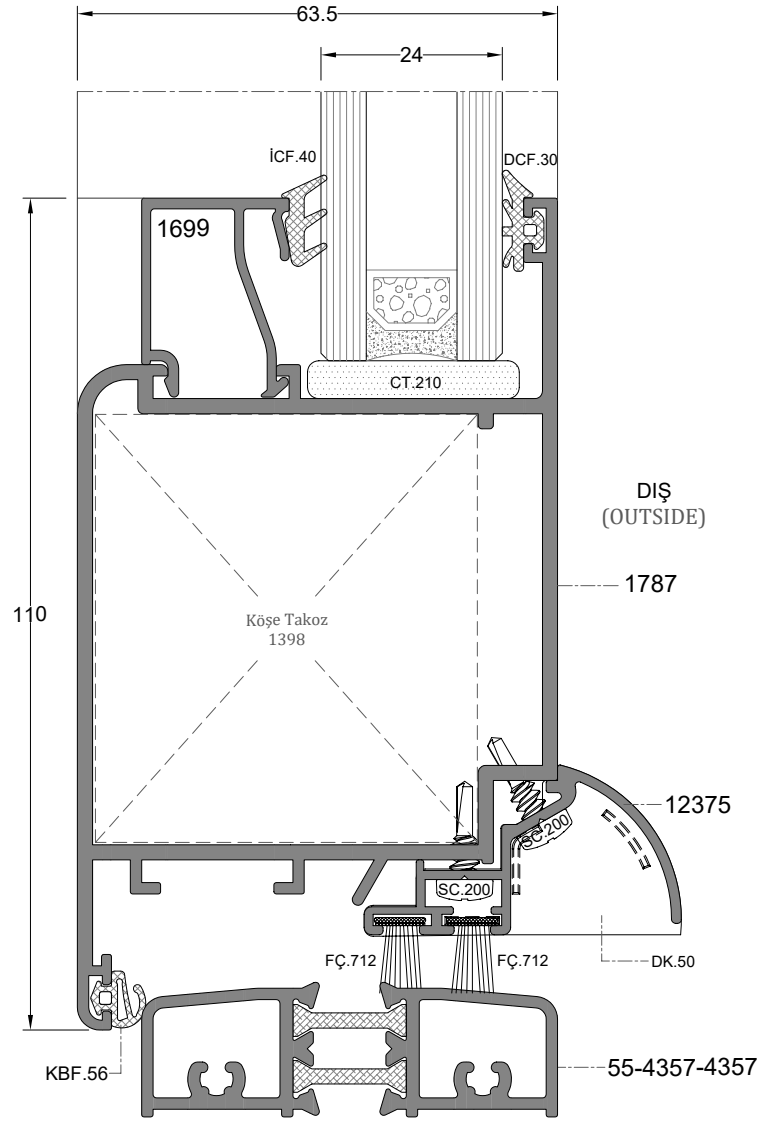
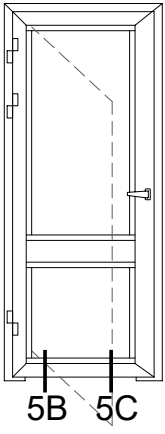

D-5C

D-5B

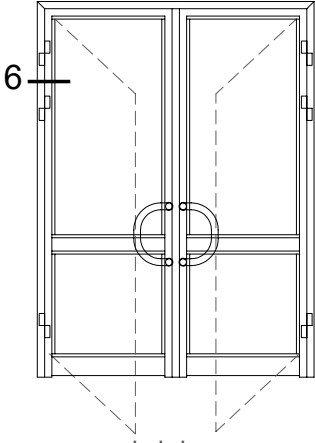

**İÇE AÇILIR BİNİLİ KAPI DETAY**  
INWARD OPENING OVERLAPPING DOOR DETAIL

İÇ  
(INSIDE)

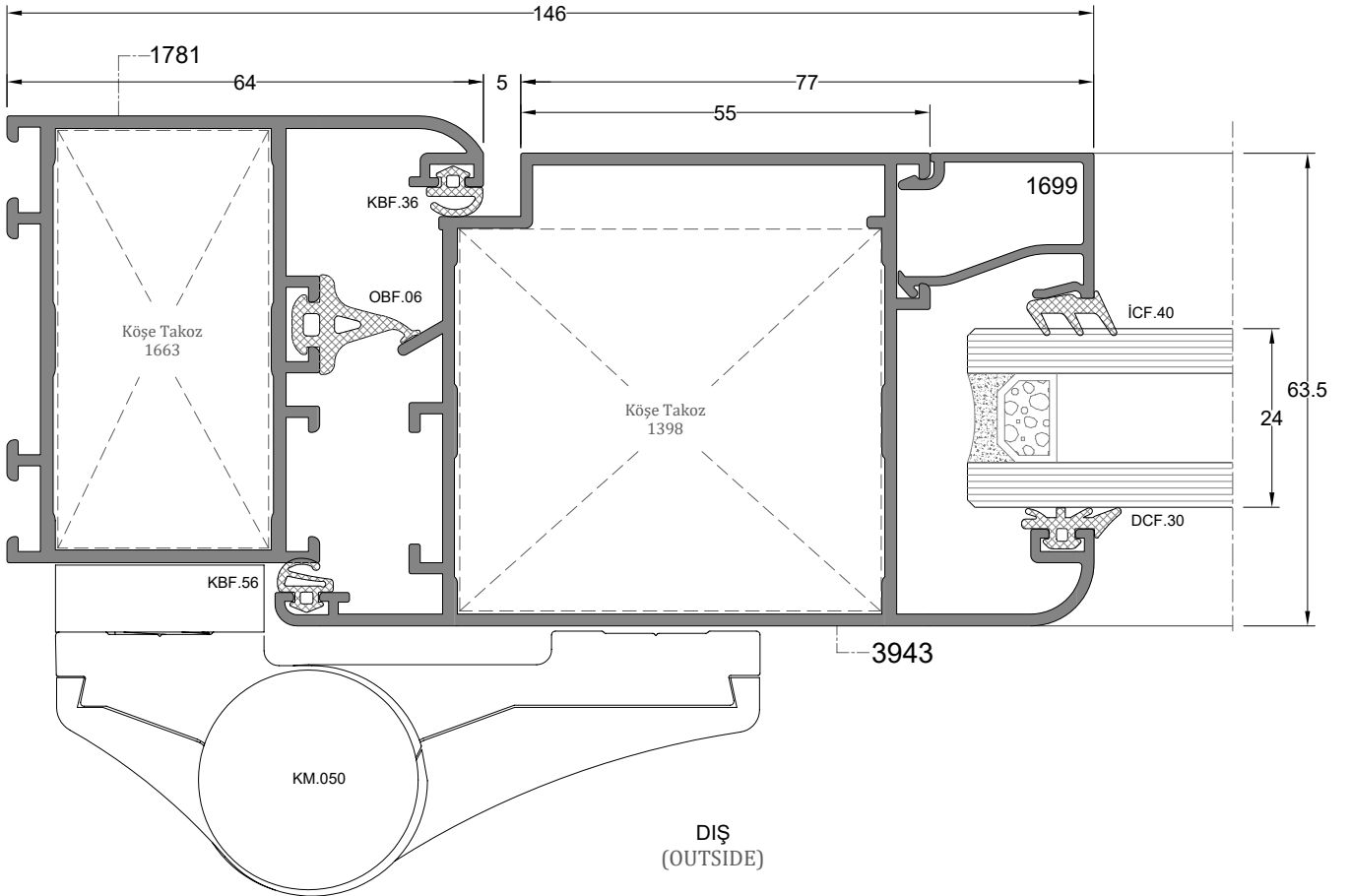

D-6

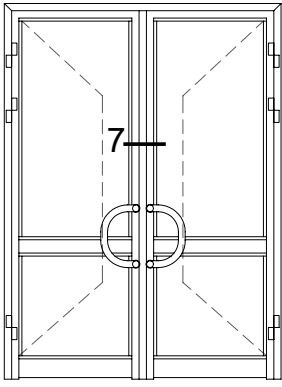

**DIŞA AÇILIR BİNİLİ KAPI DETAY**  
OUTWARD OPENING OVERLAPPING DOOR DETAIL

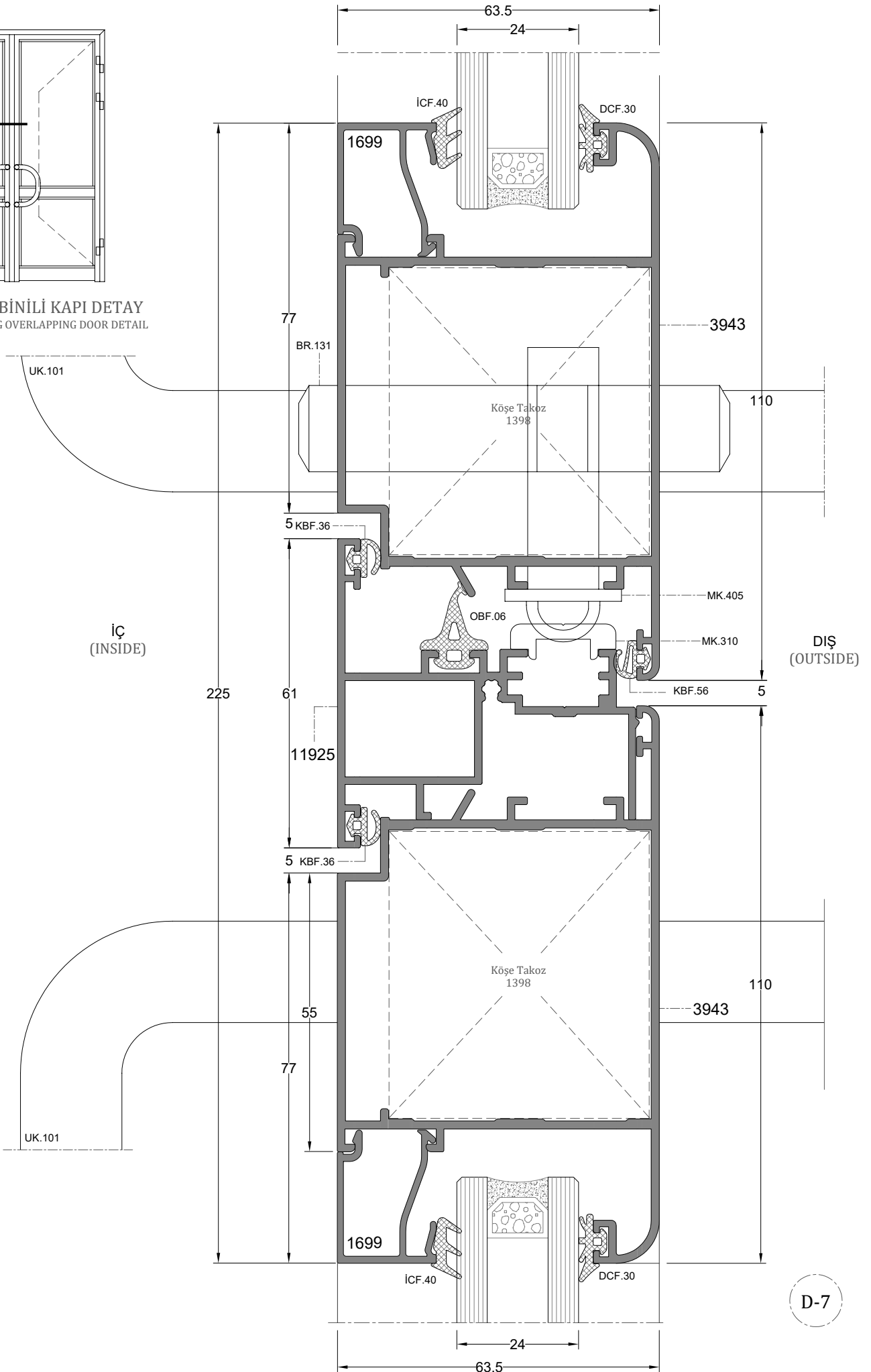

D-7



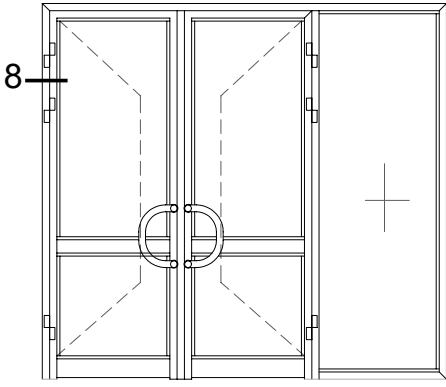

**DIŐA AÇILIR BİNİLİ KAPI DETAY**  
OUTWARD OPENING OVERLAPPING DOOR DETAIL

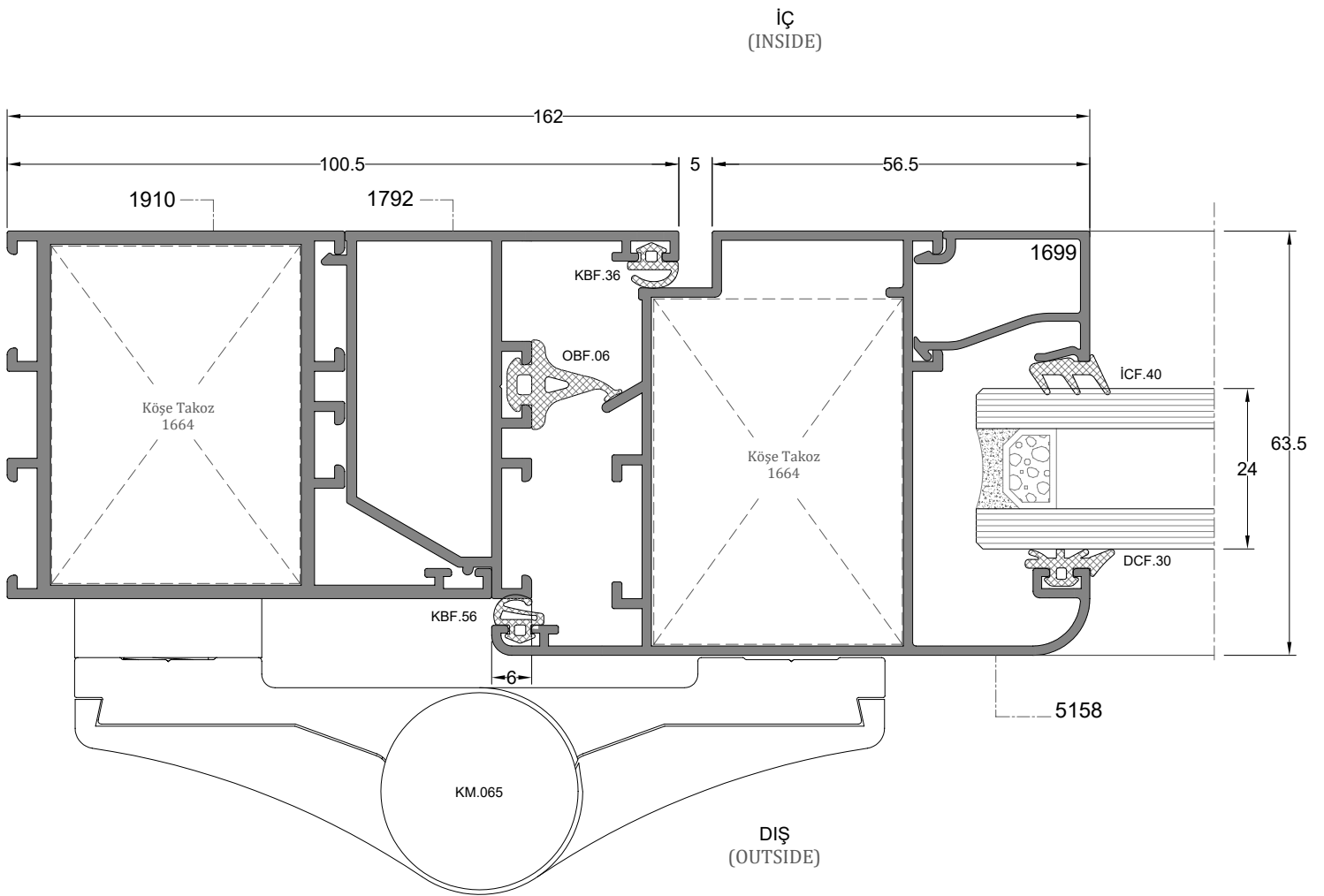

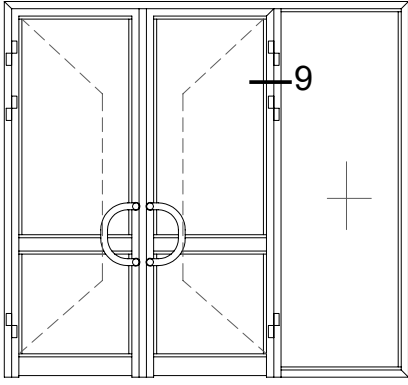

**DIŞA AÇILIR BİNİLİ KAPI DETAY**  
OUTWARD OPENING OVERLAPPING DOOR DETAIL

İÇ  
(INSIDE)

DIŞ  
(OUTSIDE)

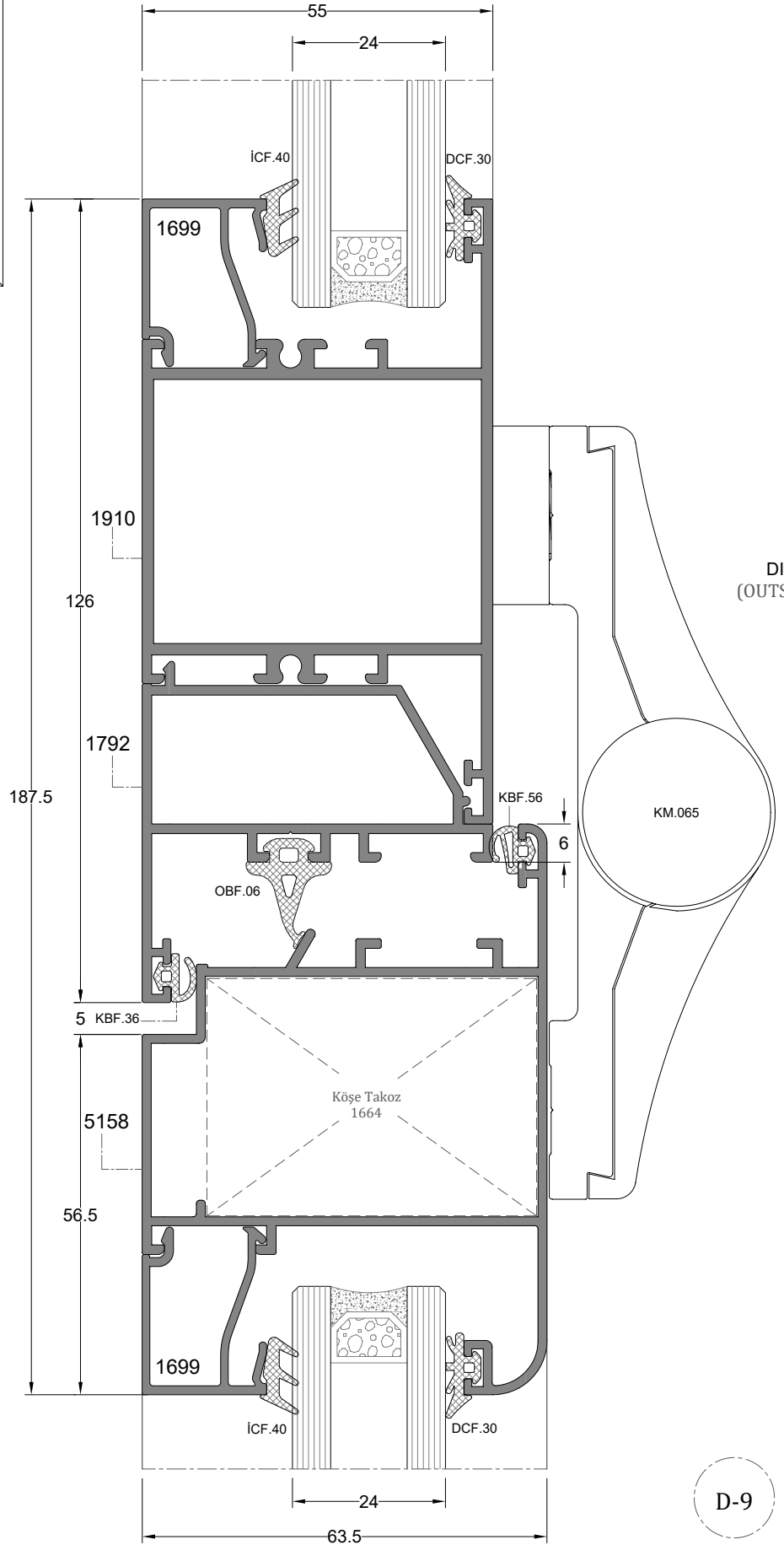

D-9

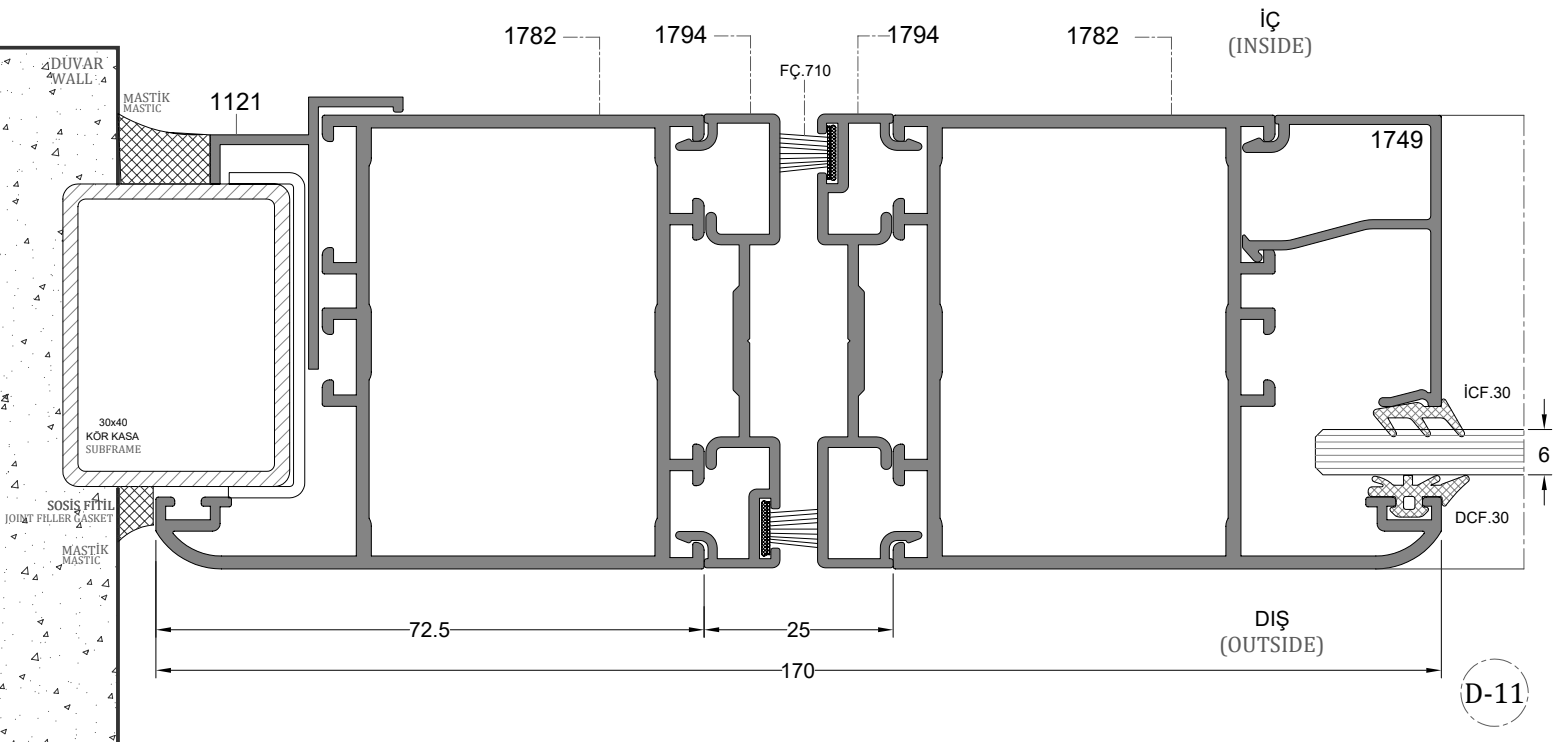
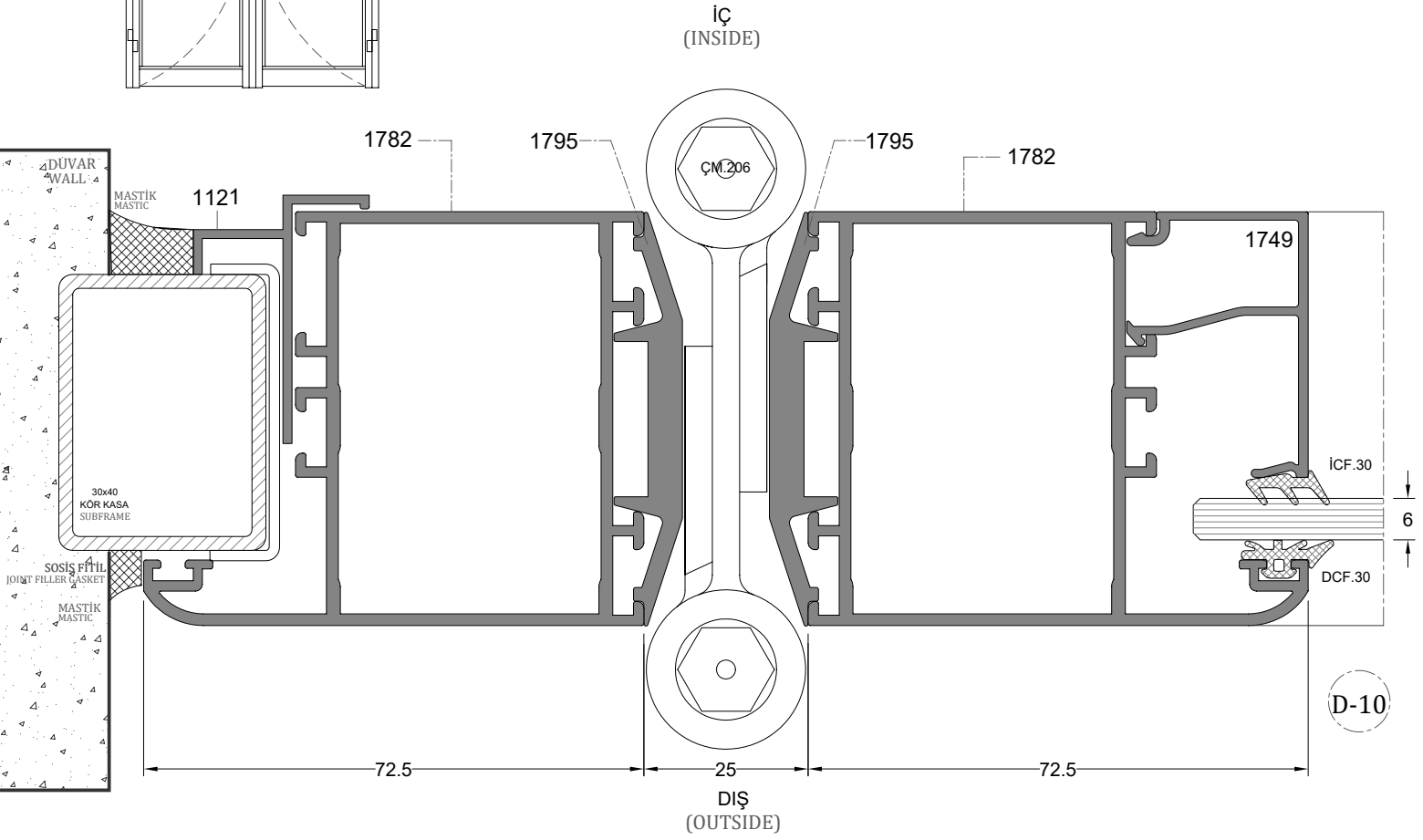
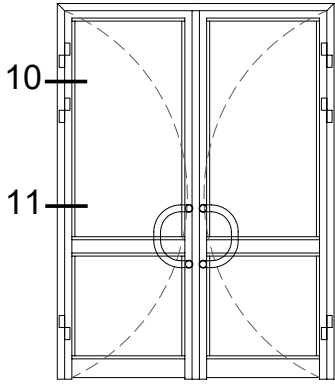

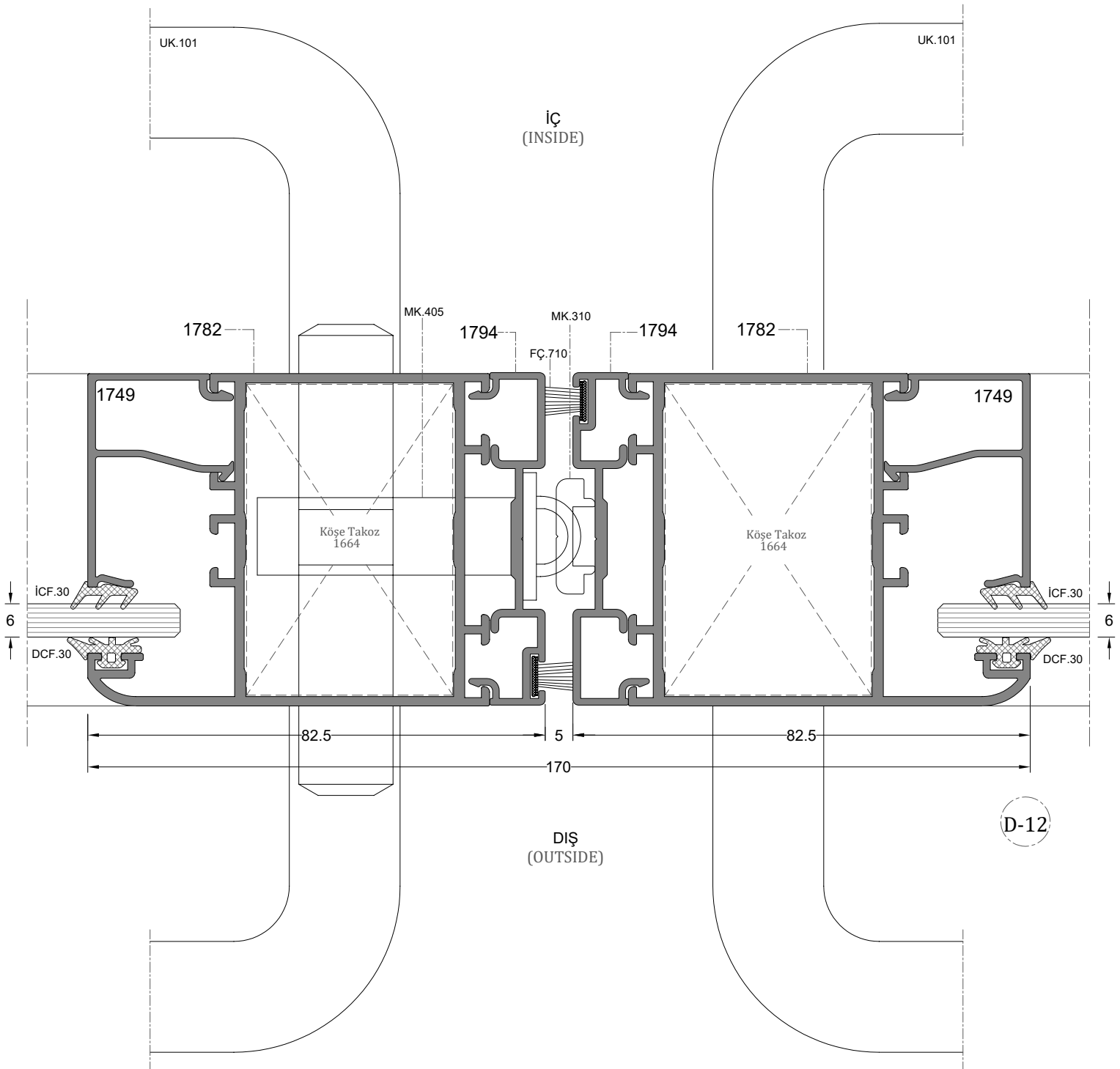
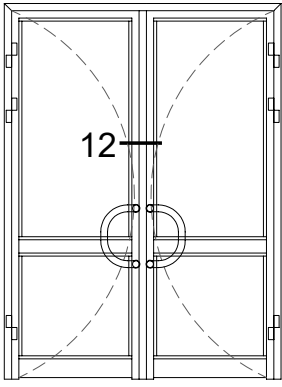

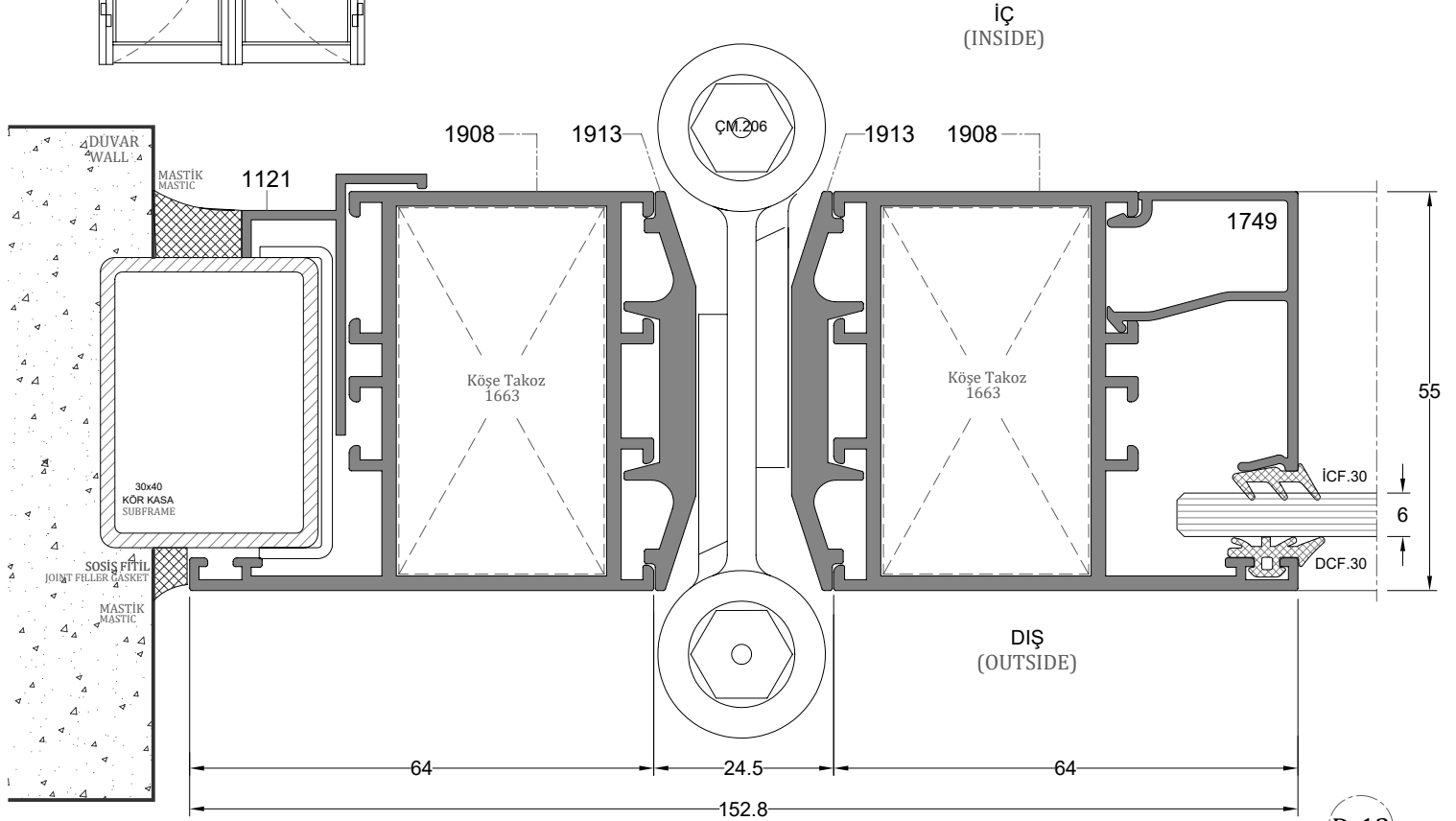
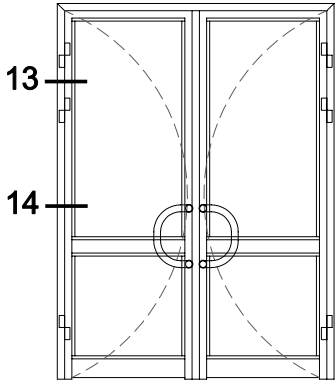

D-13

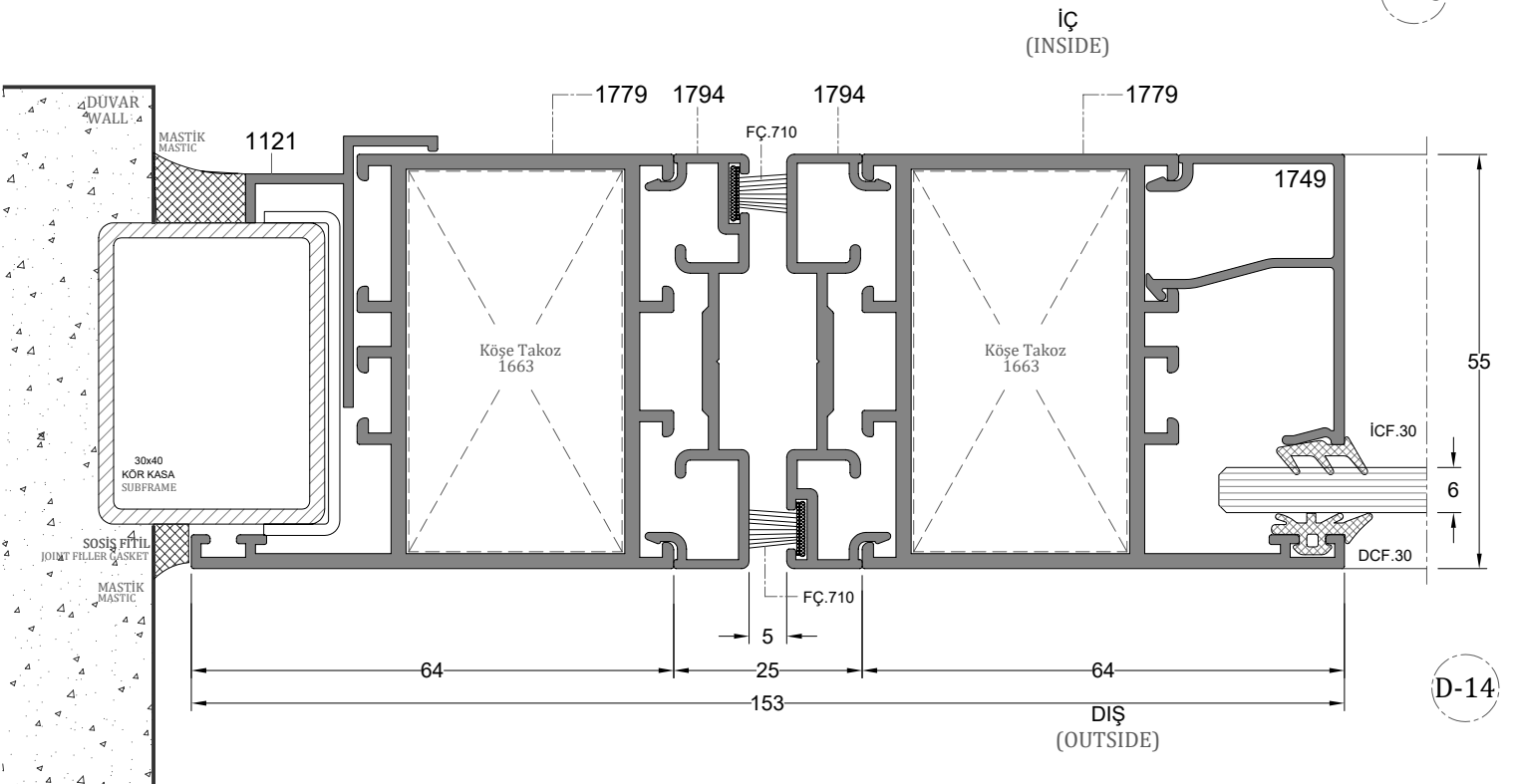

D-14

