

NOVA

BASİT SÜRME KAPI ve PENCERE SİSTEMİ

SIMPLE SLIDE DOOR and WINDOW SYSTEM

A	STATİK DİAGRAM ve PERFORMANS STATICAL DIAGRAM and PERFORMANCE	A-01 / A-09
B	ALUMİNYUM PROFİLLER ALUMINIUM PROFILES	B-01 / B-07
C	CAM MONTAJ TALİMATI GLAZING ASSEMBLY	C-01 / C-04
D	CONTALAR GASKETS	D-01 / D-04
E	AKSESUARLAR ACCESSORIES	E-01 / E-09
F	PLASTİK PROFİLLER PLASTIC PROFILES	F-01
G	UYGULANABİLİR AÇILIM TİPLERİ APPLICABLE OPENING TIPOLOGIES	G-01 / G-08
H	TAM ÖLÇEKLİ PROFİLLER FULL SCALE PROFILES	H-01 / H-15
J	PRENSİP SİSTEM DETAYLARI PRINCIPAL SECTIONS	J-01 / J-54

NOVA
BASİT SÜRME KAPI ve PENCERE SİSTEMİ
SIMPLE SLIDE DOOR and WINDOW SYSTEM

STATİK DİAGRAM ve PERFORMANS
STATICAL DIAGRAM and PERFORMANCE

RÜZGAR BASINCI ALTINDA KANAT BOYUTLANDIRMA SASH SIZE SELECTION UNDER WIND PRESSURE

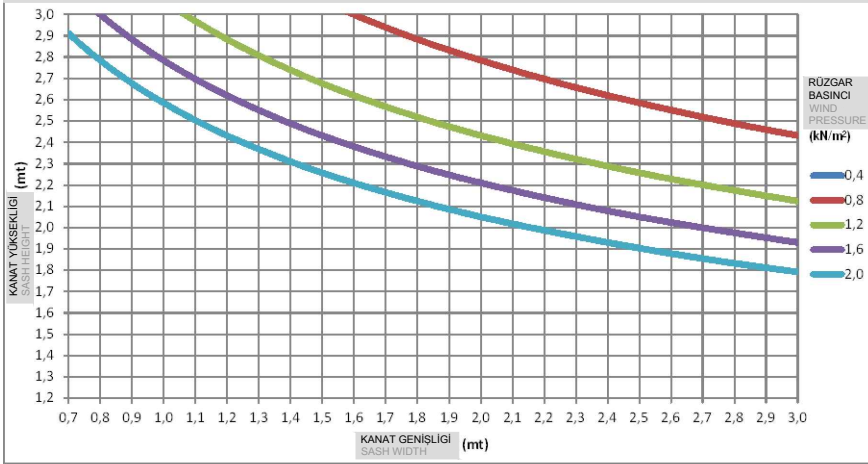

KANAT STATİK DİAGRAM STATICAL DIAGRAM for SASH

KANAT AĞIRLIĞI : 150kg
SASH WEIGHT : 150kg

SEHİM LİMİTİ L/200 yada 15mm dir.
FARKLI RENKLİ EGRİSEL ÇİZGİLER, FARKLI RÜZGAR BASINCLARI ALTINDA, UYGULANABİLİR MAKSİMUM KANAT BOYUTLARINI GÖSTERİR.
ÜSTTEKİ TABLOYA GÖRE SEÇİLEN KANAT BOYUTU, CAM TEDARİKÇİSİNE BİLDİRİLEREK, İZİN VERİLEN BOYUT ve SEHİMİN, SEÇİLEN CAMA UYGUN OLUP OLMADIĞI TEYİD EDİLMELİ ve ONAY ALINMALIDIR.
DİKKAT:

Bu statik hesap şeması ön yapısal hesaplamalar ve profil seçimi için tasarlanmıştır.
Bu şema nihai yapısal hesaplama için bir alternatif değildir, Statik Rapor olarak kullanılamaz
Statik Hesaplar Mutlaka Uygulamacı Tarafından Yapıtırılmalıdır.

DEFLECTION LIMIT L / 200 or 15mm.
THE LINE SHOW MAXIMUM SIZES FOR THE INDICATE PRESSURE.
VERIFY THAT THE DEFLECTION OF THE SECTION IS COMPATIBLE WITH THE EMPLOYED GLASS.

DIN EN 12210 for the standard building area
Deflection limit L/200 or max. 15mm in accordance with TRLV
Differing deflection limits set by the double glazing manufacturer must be observed.
These statics diagram are intended for preliminary structural calculations and profile selection.
This is not a substitute for a final structural calculation.
Sash sizes below the line are structurally adequate.

RÜZGAR BASINCI ALTINDA KANAT BOYUTLANDIRMA SASH SIZE SELECTION UNDER WIND PRESSURE

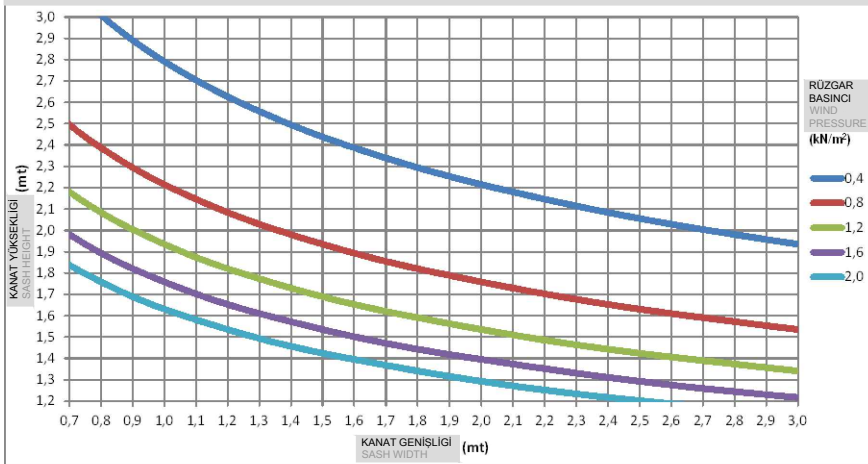

KANAT AĞIRLIĞI : 150kg
SASH WEIGHT : 150kg

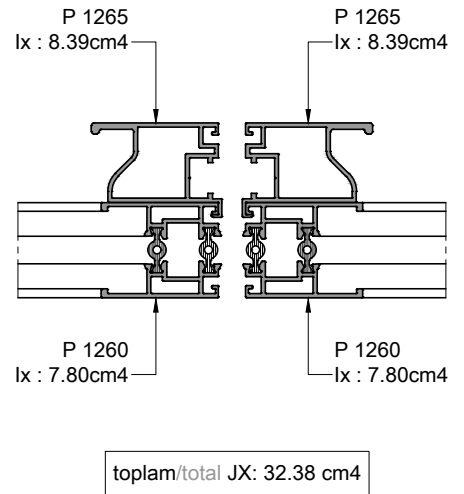
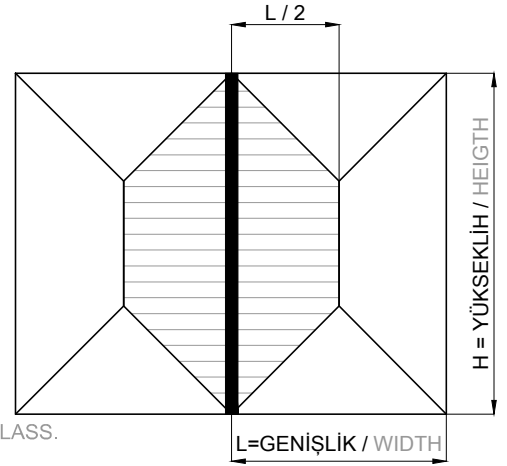
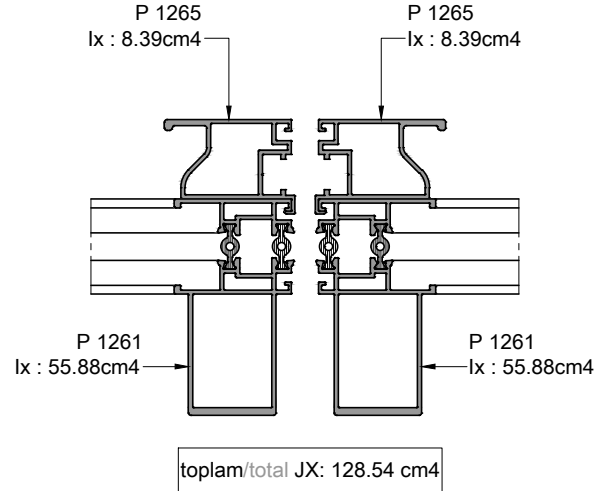

RÜZGAR BASINCI ALTINDA KANAT BOYUTLANDIRMA SASH SIZE SELECTION UNDER WIND PRESSURE

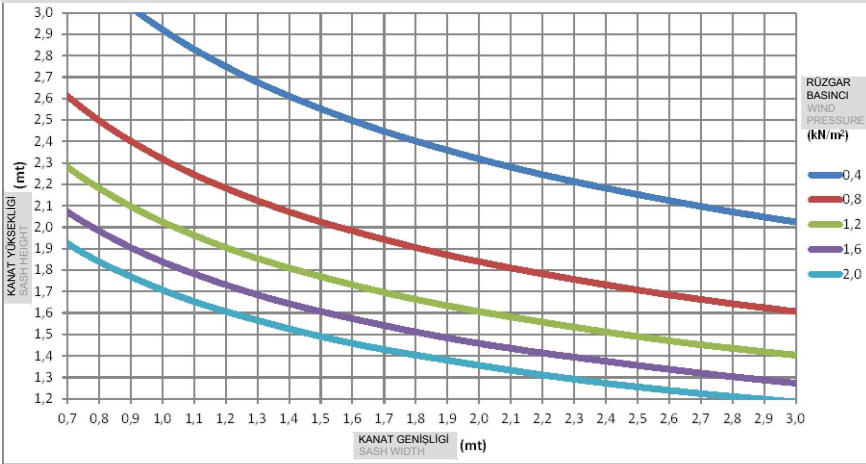

KANAT STATİK DİAGRAM
STATICAL DIAGRAM for SASH

KANAT AĞIRLIĞI : 150kg
SASH WEIGHT : 150kg

SEHİM LİMİTİ L/200 yada 15mm dir.
FARKLI RENKLİ EGRİSEL ÇİZGİLER, FARKLI RÜZGAR BASINCLARI ALTINDA, UYGULANABİLİR MAKSİMUM KANAT BOYUTLARINI GÖSTERİR.
ÜSTTEKİ TABLOYA GÖRE SEÇİLEN KANAT BOYUTU, CAM TEDARİKÇİSİNE BİLDİRİLEREK, İZİN VERİLEN BOYUT ve SEHİMİN, SEÇİLEN CAMA UYGUN OLUP OLMADIĞI TEYİD EDİLMELİ ve ONAY ALINMALIDIR.
DİKKAT:

Bu statik hesap şeması ön yapısal hesaplamalar ve profil seçimi için tasarlanmıştır.
Bu şema nihai yapısal hesaplama için bir alternatif değildir, Statik Rapor olarak kullanılamaz
Statik Hesaplar Mutlaka Uygulamacı Tarafından Yapılmalıdır.

DEFLECTION LIMIT L / 200 or 15mm.
THE LINE SHOW MAXIMUM SIZES FOR THE INDICATE PRESSURE.
VERIFY THAT THE DEFLECTION OF THE SECTION IS COMPATIBLE WITH THE EMPLOYED GLASS.

DIN EN 12210 for the standard building area
Deflection limit L/200 or max. 15mm in accordance with TRLV
Differing deflection limits set by the double glazing manufacturer must be observed.
These statics diagram are intended for preliminary structural calculations and profile selection.
This is not a substitute for a final structural calculation.
Sash sizes below the line are structurally adequate.

RÜZGAR BASINCI ALTINDA KANAT BOYUTLANDIRMA SASH SIZE SELECTION UNDER WIND PRESSURE

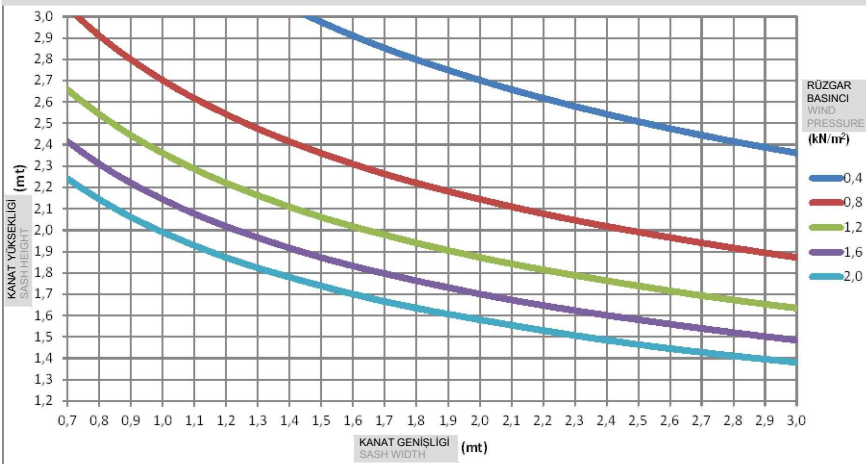

KANAT AĞIRLIĞI : 150kg
SASH WEIGHT : 150kg

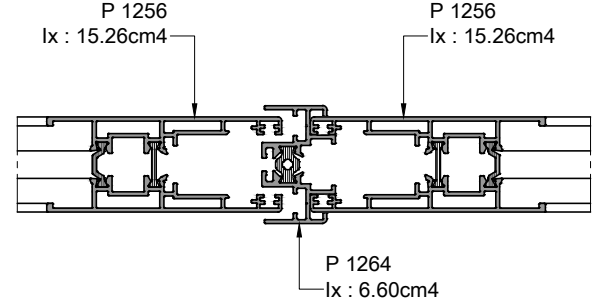

toplam/total JX: 37.12 cm⁴

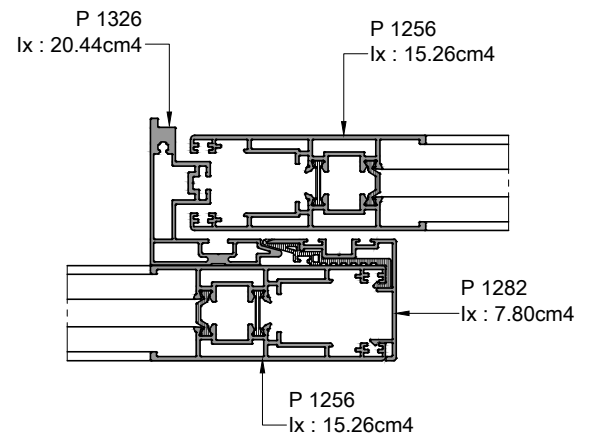
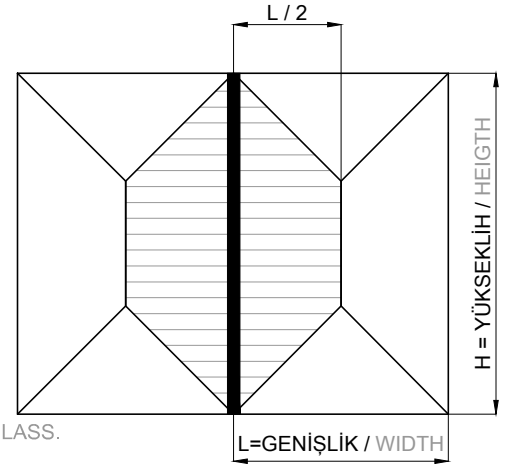

toplam/total JX: 58.76 cm⁴

RÜZGAR BASINCI ALTINDA KANAT BOYUTLANDIRMA SASH SIZE SELECTION UNDER WIND PRESSURE

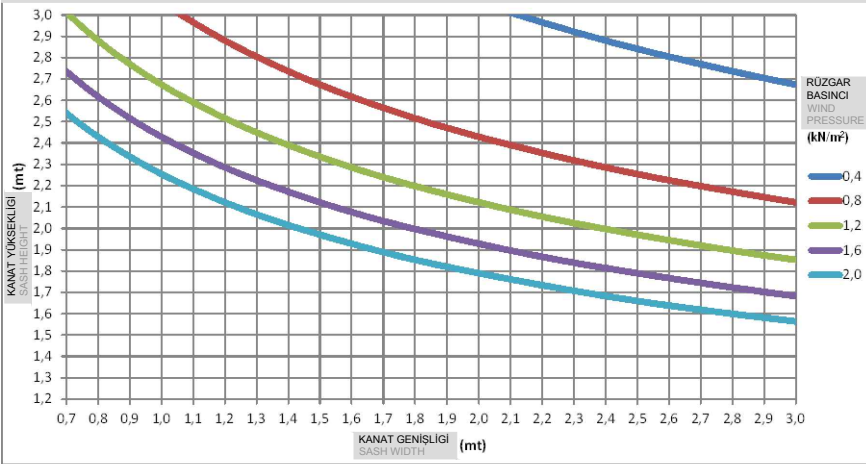

KANAT STATİK DİAGRAM
STATICAL DIAGRAM for SASH

KANAT AĞIRLIĞI : 150kg
SASH WEIGHT : 150kg

SEHİM LİMİTİ L/200 yada 15mm dir.
FARKLI RENKLİ EGRİSEL ÇİZGİLER, FARKLI RÜZGAR BASINCLARI ALTINDA, UYGULANABİLİR MAKSİMUM KANAT BOYUTLARINI GÖSTERİR.
ÜSTTEKİ TABLOYA GÖRE SEÇİLEN KANAT BOYUTU, CAM TEDARİKÇİSİNE BİLDİRİLEREK, İZİN VERİLEN BOYUT ve SEHİMİN, SEÇİLEN CAMA UYGUN OLUP OLMADIĞI TEYİD EDİLMELİ ve ONAY ALINMALIDIR.
DİKKAT:

Bu statik hesap şeması ön yapısal hesaplamalar ve profil seçimi için tasarlanmıştır.
Bu şema nihai yapısal hesaplama için bir alternatif değildir, Statik Rapor olarak kullanılamaz
Statik Hesaplar Mutlaka Uygulamacı Tarafından Yapıtırılmalıdır.

DEFLECTION LIMIT L / 200 or 15mm.
THE LINE SHOW MAXIMUM SIZES FOR THE INDICATE PRESSURE.
VERIFY THAT THE DEFLECTION OF THE SECTION IS COMPATIBLE WITH THE EMPLOYED GLASS.

DIN EN 12210 for the standard building area
Deflection limit L/200 or max. 15mm in accordance with TRLV
Differing deflection limits set by the double glazing manufacturer must be observed.
These statics diagram are intended for preliminary structural calculations and profile selection.
This is not a substitute for a final structural calculation.
Sash sizes below the line are structurally adequate.

RÜZGAR BASINCI ALTINDA KANAT BOYUTLANDIRMA SASH SIZE SELECTION UNDER WIND PRESSURE

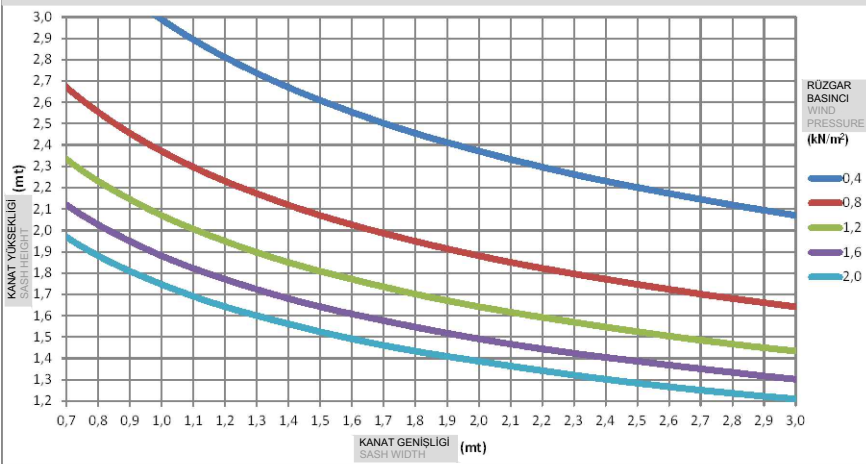

KANAT AĞIRLIĞI : 150kg
SASH WEIGHT : 150kg

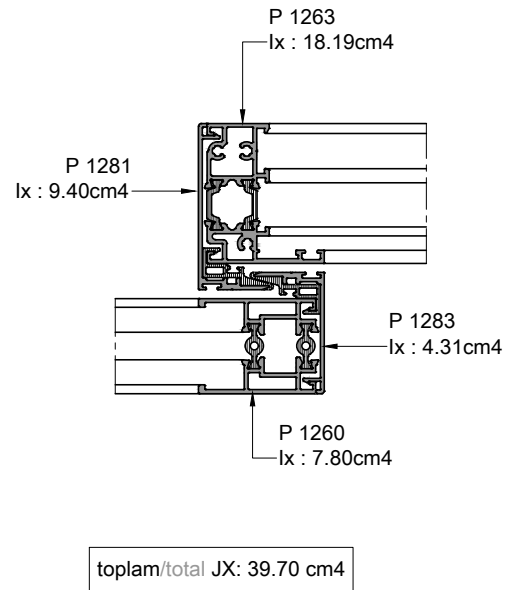
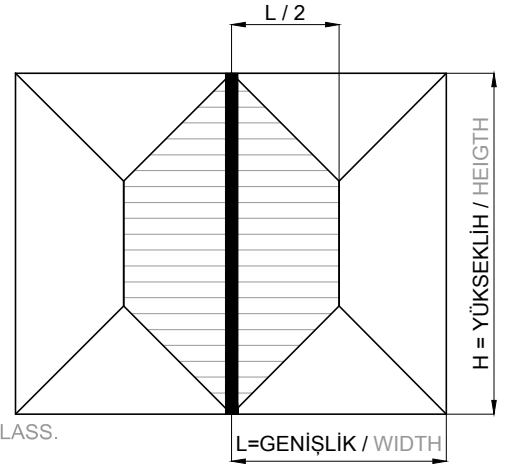
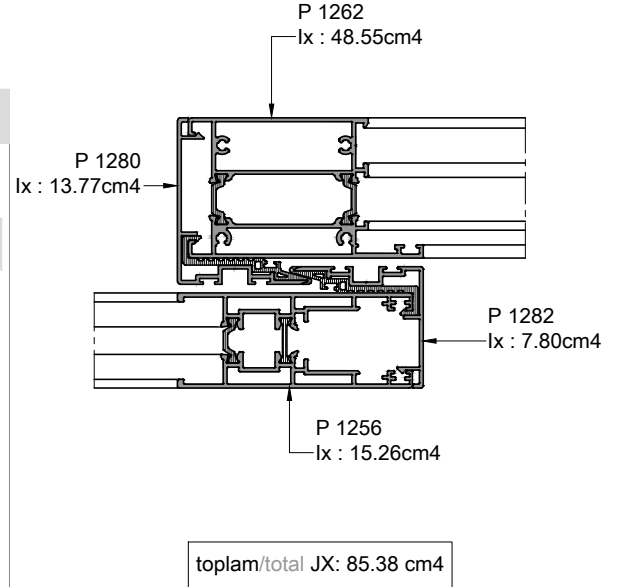

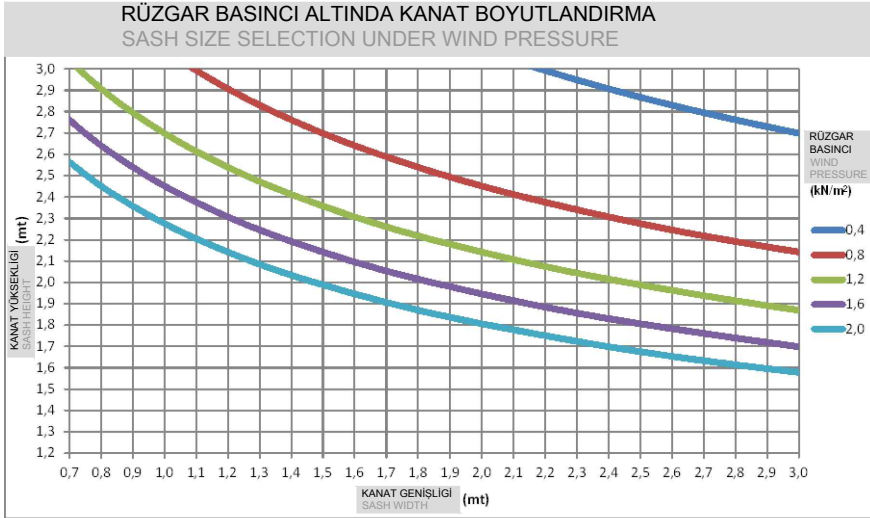

KANAT STATİK DİAGRAM
STATICAL DIAGRAM for SASH

KANAT AĞIRLIĞI : 150kg
SASH WEIGHT : 150kg

SEHİM LİMİTİ L/200 yada 15mm dir.
FARKLI RENKLİ EGRİSEL ÇİZGİLER, FARKLI RÜZGAR BASINCLARI ALTINDA, UYGULANABİLİR MAKSİMUM KANAT BOYUTLARINI GÖSTERİR.
ÜSTTEKİ TABLOYA GÖRE SEÇİLEN KANAT BOYUTU, CAM TEDARİKÇİSİNE BİLDİRİLEREK, İZİN VERİLEN BOYUT ve SEHİMİN, SEÇİLEN CAMA UYGUN OLUP OLMADIĞI TEYİD EDİLMELİ ve ONAY ALINMALIDIR.
DİKKAT:

Bu statik hesap şeması ön yapısal hesaplamalar ve profil seçimi için tasarlanmıştır.
Bu şema nihai yapısal hesaplama için bir alternatif değildir, Statik Rapor olarak kullanılamaz
Statik Hesaplar Mutlaka Uygulamacı Tarafından Yapılmalıdır.

DEFLECTION LIMIT L / 200 or 15mm.
THE LINE SHOW MAXIMUM SIZES FOR THE INDICATE PRESSURE.
VERIFY THAT THE DEFLECTION OF THE SECTION IS COMPATIBLE WITH THE EMPLOYED GLASS.

DIN EN 12210 for the standard building area
Deflection limit L/200 or max. 15mm in accordance with TRLV
Differing deflection limits set by the double glazing manufacturer must be observed.
These statics diagram are intended for preliminary structural calculations and profile selection.
This is not a substitute for a final structural calculation.
Sash sizes below the line are structurally adequate.

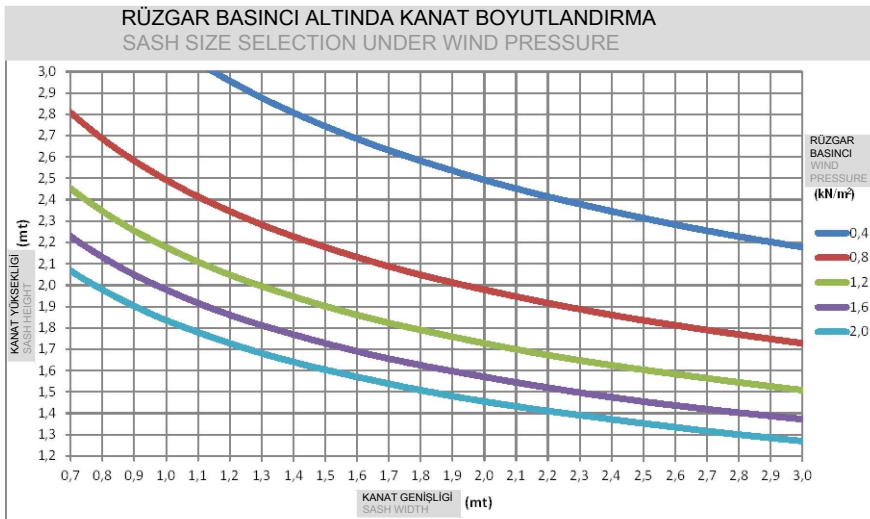

KANAT AĞIRLIĞI : 150kg
SASH WEIGHT : 150kg

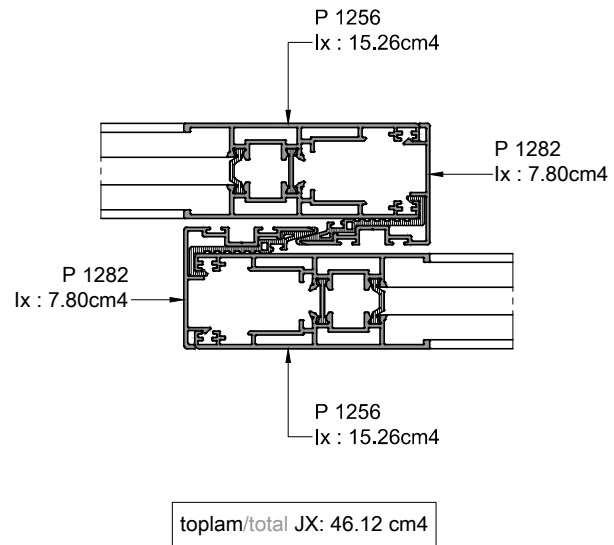
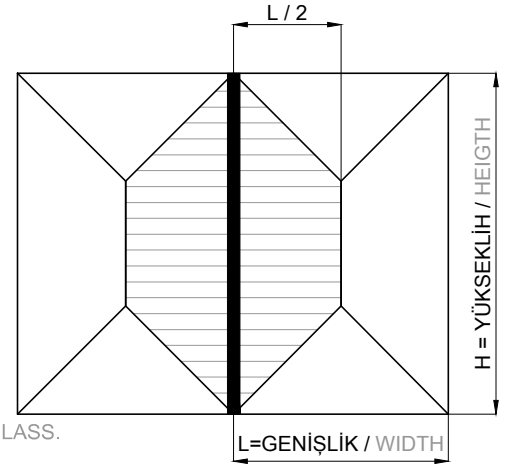
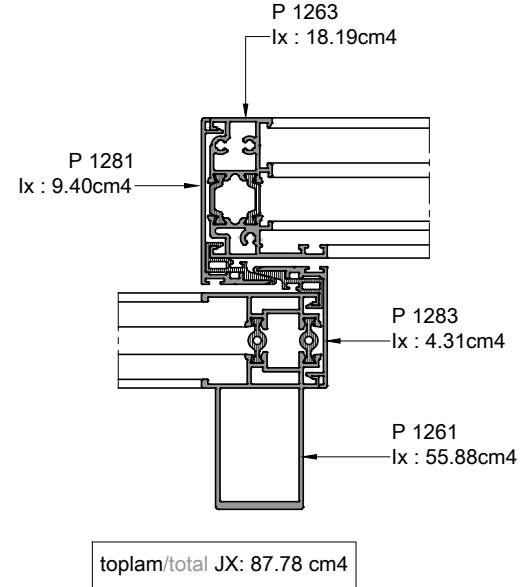

RÜZGAR BASINCI ALTINDA KANAT BOYUTLANDIRMA SASH SIZE SELECTION UNDER WIND PRESSURE

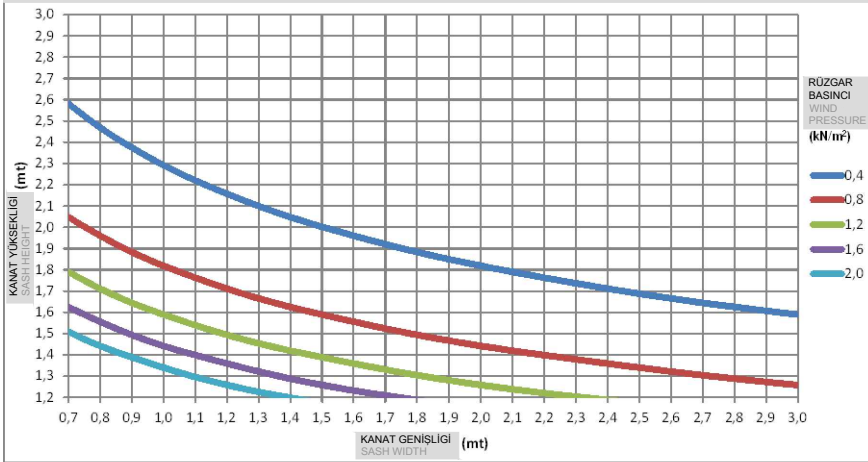

KANAT STATİK DİAGRAM STATICAL DIAGRAM for SASH

KANAT AĞIRLIĞI : 150kg
SASH WEIGHT : 150kg

SEHİM LİMİTİ L/200 yada 15mm dir.
FARKLI RENKLİ EGRİSEL ÇİZGİLER, FARKLI RÜZGAR BASINCLARI ALTINDA, UYGULANABİLİR MAKSİMUM KANAT BOYUTLARINI GÖSTERİR.
ÜSTTEKİ TABLOYA GÖRE SEÇİLEN KANAT BOYUTU, CAM TEDARİKÇİSİNE BİLDİRİLEREK, İZİN VERİLEN BOYUT ve SEHİMİN, SEÇİLEN CAMA UYGUN OLUP OLMADIĞI TEYİD EDİLMELİ ve ONAY ALINMALIDIR.
DİKKAT:

Bu statik hesap şeması ön yapısal hesaplamalar ve profil seçimi için tasarlanmıştır.
Bu şema nihai yapısal hesaplama için bir alternatif değildir, Statik Rapor olarak kullanılamaz
Statik Hesaplar Mutlaka Uygulamacı Tarafından Yapıtırılmalıdır.

DEFLECTION LIMIT L / 200 or 15mm.
THE LINE SHOW MAXIMUM SIZES FOR THE INDICATE PRESSURE.
VERIFY THAT THE DEFLECTION OF THE SECTION IS COMPATIBLE WITH THE EMPLOYED GLASS.

DIN EN 12210 for the standard building area
Deflection limit L/200 or max. 15mm in accordance with TRLV
Differing deflection limits set by the double glazing manufacturer must be observed.
These statics diagram are intended for preliminary structural calculations and profile selection.
This is not a substitute for a final structural calculation.
Sash sizes below the line are structurally adequate.

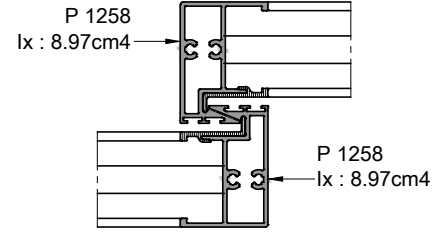

toplam/total JX: 17.94 cm⁴

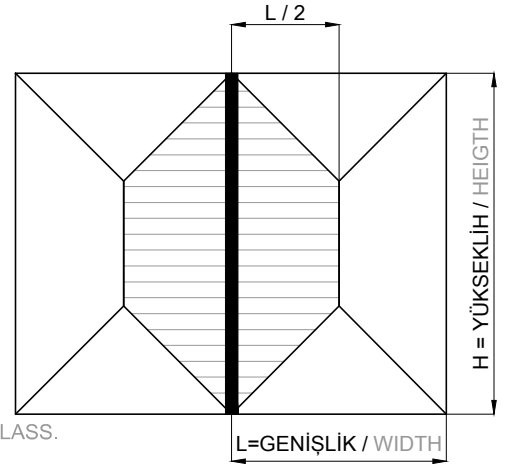

RÜZGAR BASINCI ALTINDA KANAT BOYUTLANDIRMA SASH SIZE SELECTION UNDER WIND PRESSURE

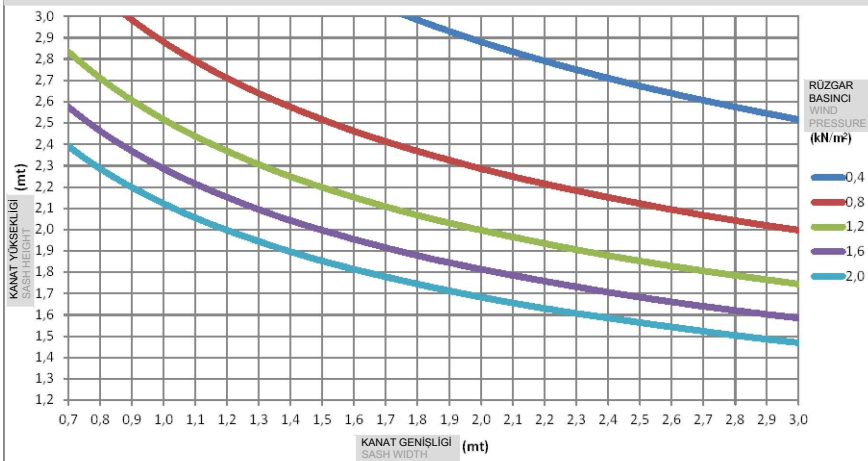

KANAT AĞIRLIĞI : 150kg
SASH WEIGHT : 150kg

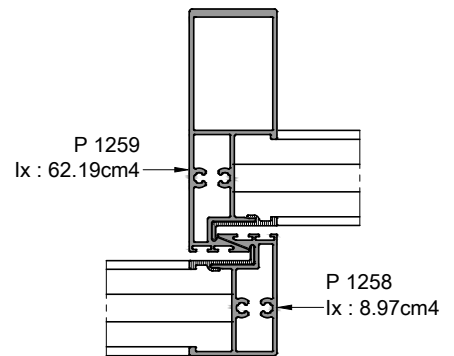

toplam/total JX: 71.16 cm⁴

RÜZGAR BASINCI ALTINDA KANAT BOYUTLANDIRMA SASH SIZE SELECTION UNDER WIND PRESSURE

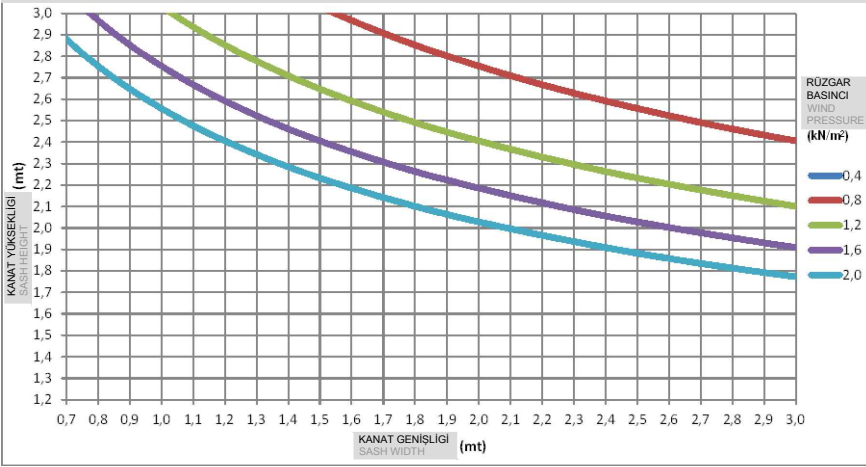

KANAT STATİK DİAGRAM
STATICAL DIAGRAM for SASH

KANAT AĞIRLIĞI : 150kg
SASH WEIGHT : 150kg

SEHİM LİMİTİ L/200 yada 15mm dir.
FARKLI RENKLİ EGRİSEL ÇİZGİLER, FARKLI RÜZGAR BASINCLARI ALTINDA,
UYGULANABİLİR MAKSİMUM KANAT BOYUTLARINI GÖSTERİR.
ÜSTTEKİ TABLOYA GÖRE SEÇİLEN KANAT BOYUTU, CAM TEDARİKÇİSİNE BİLDİRİLEREK,
İZİN VERİLEN BOYUT ve SEHİMİN, SEÇİLEN
CAMA UYGUN OLUP OLMADIĞI TEYİD EDİLMELİ ve ONAY ALINMALIDIR.
DİKKAT:

Bu statik hesap şeması ön yapısal hesaplamalar ve profil seçimi için tasarlanmıştır.
Bu şema nihai yapısal hesaplama için bir alternatif değildir, Statik Rapor olarak kullanılamaz
Statik Hesaplar Mutlaka Uygulamacı Tarafından Yapılmalıdır.

DEFLECTION LIMIT L / 200 or 15mm.
THE LINE SHOW MAXIMUM SIZES FOR THE INDICATE PRESSURE.
VERIFY THAT THE DEFLECTION OF THE SECTION IS COMPATIBLE WITH THE EMPLOYED GLASS.

DIN EN 12210 for the standard building area
Deflection limit L/200 or max. 15mm in accordance with TRLV
Differing deflection limits set by the double glazing manufacturer must be observed.
These statics diagram are intended for preliminary structural calculations and profile selection.
This is not a substitute for a final structural calculation.
Sash sizes below the line are structurally adequate.

RÜZGAR BASINCI ALTINDA KANAT BOYUTLANDIRMA SASH SIZE SELECTION UNDER WIND PRESSURE

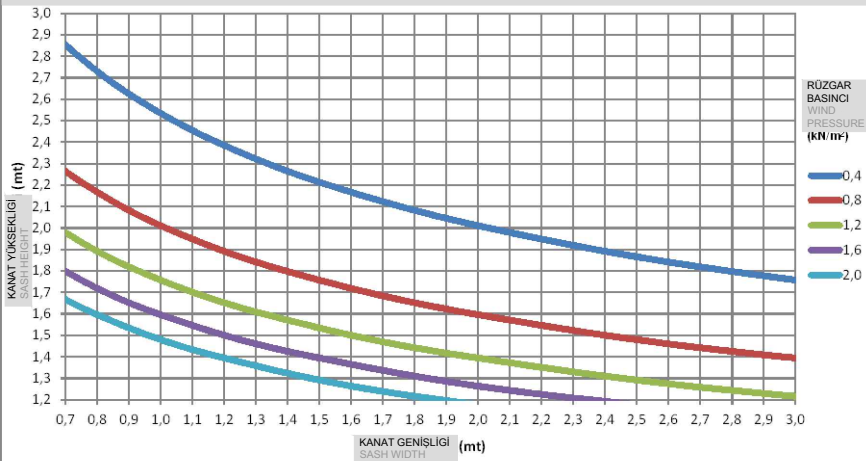

KANAT AĞIRLIĞI : 150kg
SASH WEIGHT : 150kg

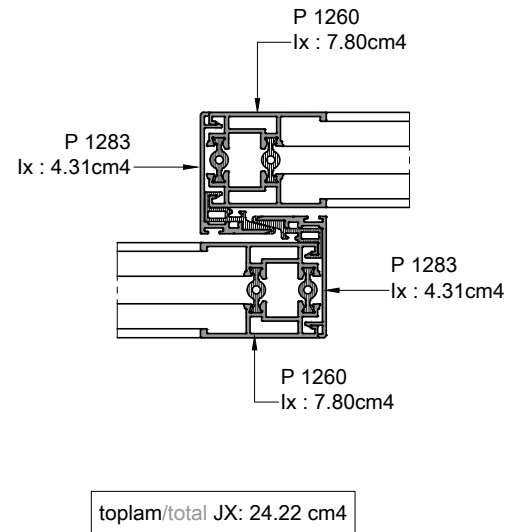
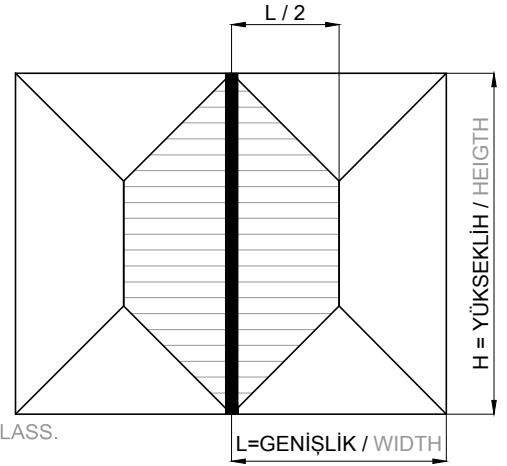
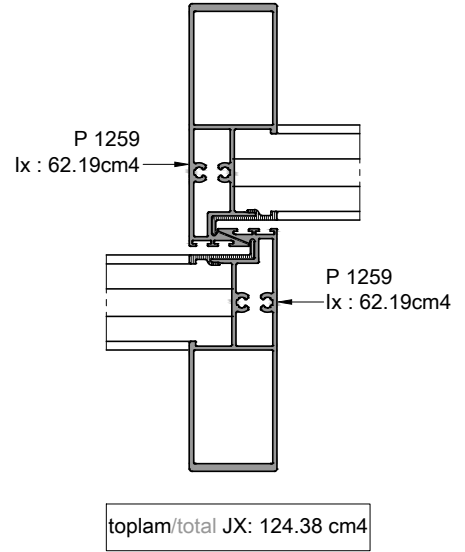

RÜZGAR BASINCI ALTINDA KANAT BOYUTLANDIRMA SASH SIZE SELECTION UNDER WIND PRESSURE

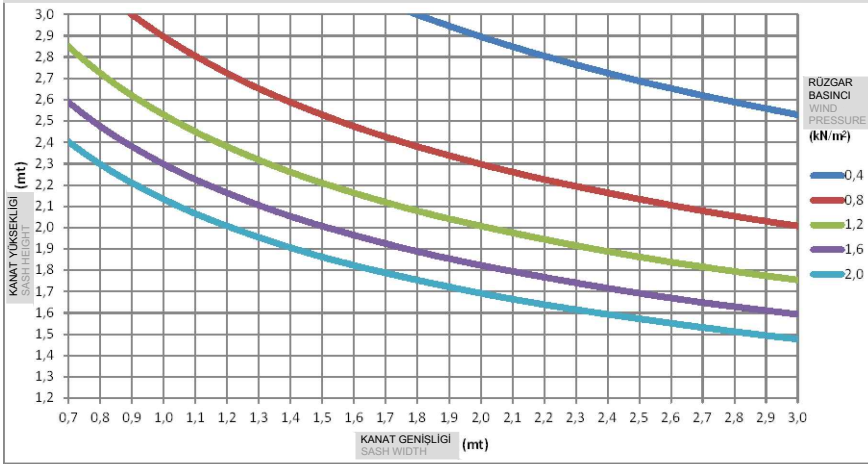

KANAT STATİK DİAGRAM STATICAL DIAGRAM for SASH

KANAT AĞIRLIĞI : 150kg
SASH WEIGHT : 150kg

SEHİM LİMİTİ L/200 yada 15mm dir.
FARKLI RENKLİ EGRİSEL ÇİZGİLER, FARKLI RÜZGAR BASINCLARI ALTINDA, UYGULANABİLİR MAKSİMUM KANAT BOYUTLARINI GÖSTERİR.
ÜSTTEKİ TABLOYA GÖRE SEÇİLEN KANAT BOYUTU, CAM TEDARİKÇİSİNE BİLDİRİLEREK, İZİN VERİLEN BOYUT ve SEHİMİN, SEÇİLEN CAMA UYGUN OLUP OLMADIĞI TEYİD EDİLMELİ ve ONAY ALINMALIDIR.
DİKKAT:

Bu statik hesap şeması ön yapısal hesaplamalar ve profil seçimi için tasarlanmıştır.
Bu şema nihai yapısal hesaplama için bir alternatif değildir, Statik Rapor olarak kullanılamaz
Statik Hesaplar Mutlaka Uygulamacı Tarafından Yapılmalıdır.

DEFLECTION LIMIT L / 200 or 15mm.
THE LINE SHOW MAXIMUM SIZES FOR THE INDICATE PRESSURE.
VERIFY THAT THE DEFLECTION OF THE SECTION IS COMPATIBLE WITH THE EMPLOYED GLASS.

DIN EN 12210 for the standard building area
Deflection limit L/200 or max. 15mm in accordance with TRLV
Differing deflection limits set by the double glazing manufacturer must be observed.
These statics diagram are intended for preliminary structural calculations and profile selection.
This is not a substitute for a final structural calculation.
Sash sizes below the line are structurally adequate.

RÜZGAR BASINCI ALTINDA KANAT BOYUTLANDIRMA SASH SIZE SELECTION UNDER WIND PRESSURE

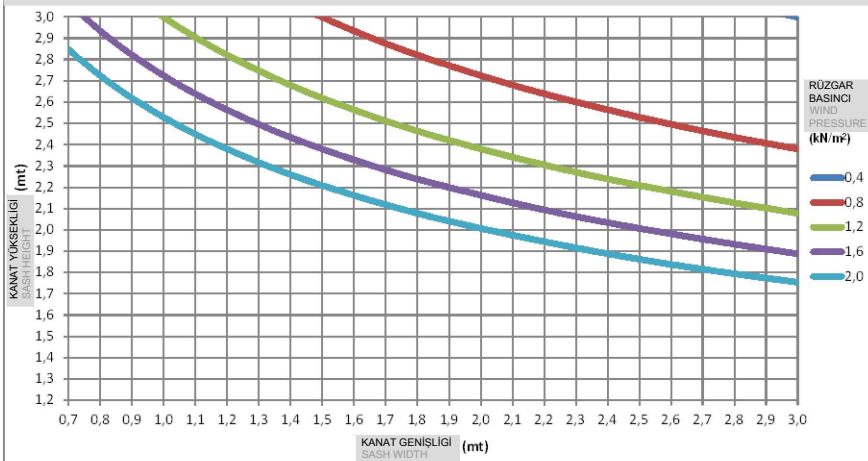

KANAT AĞIRLIĞI : 150kg
SASH WEIGHT : 150kg

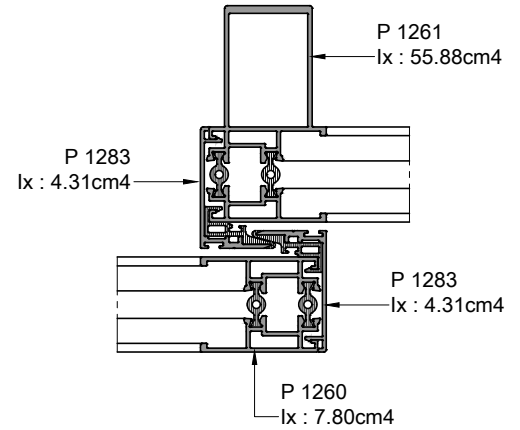

toplam/total JX: 72.30 cm4

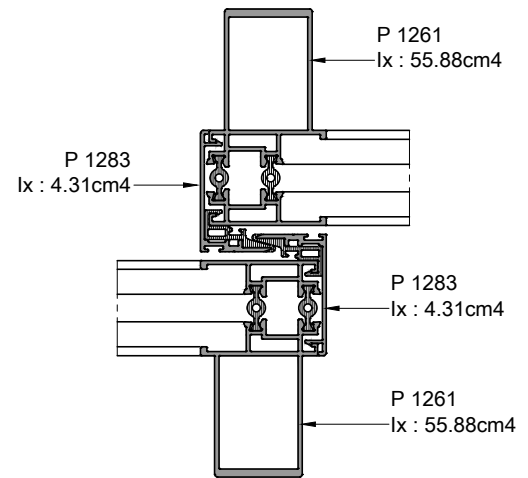
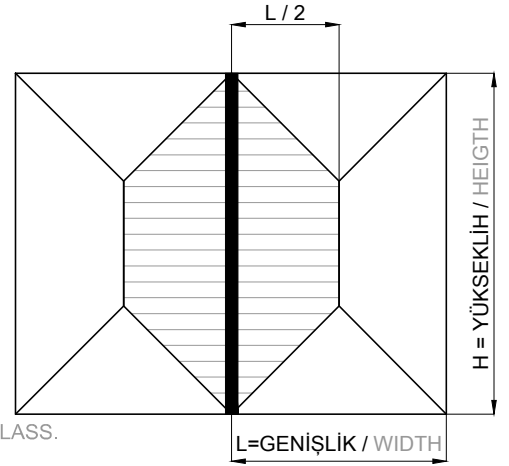

toplam/total JX: 120.38 cm4

RÜZGAR BASINCI ALTINDA KANAT BOYUTLANDIRMA SASH SIZE SELECTION UNDER WIND PRESSURE

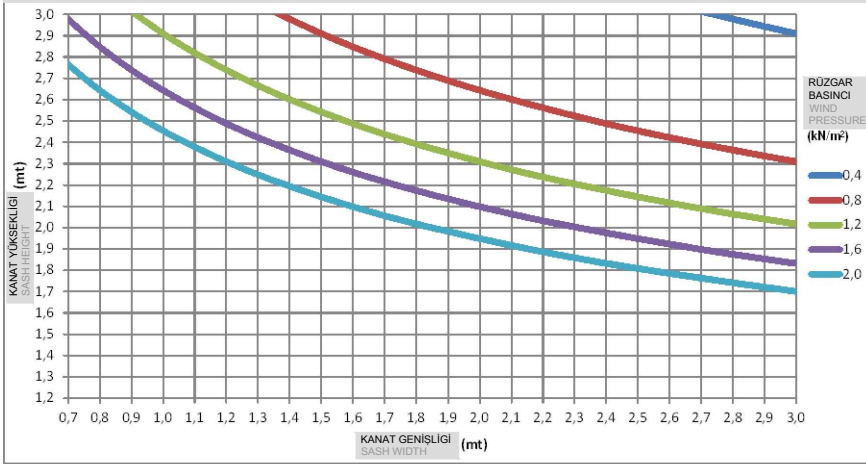

KANAT STATİK DİAGRAM
STATICAL DIAGRAM for SASH

KANAT AĞIRLIĞI : 150kg
SASH WEIGHT : 150kg

SEHİM LİMİTİ L/200 yada 15mm dir.
FARKLI RENKLİ EGRİSEL ÇİZGİLER, FARKLI RÜZGAR BASINCLARI ALTINDA, UYGULANABİLİR MAKSİMUM KANAT BOYUTLARINI GÖSTERİR.
ÜSTTEKİ TABLOYA GÖRE SEÇİLEN KANAT BOYUTU, CAM TEDARİKÇİSİNE BİLDİRİLEREK, İZİN VERİLEN BOYUT ve SEHİMİN, SEÇİLEN CAMA UYGUN OLUP OLMADIĞI TEYİD EDİLMELİ ve ONAY ALINMALIDIR.
DİKKAT:

Bu statik hesap şeması ön yapısal hesaplamalar ve profil seçimi için tasarlanmıştır.
Bu şema nihai yapısal hesaplama için bir alternatif değildir, Statik Rapor olarak kullanılamaz
Statik Hesaplar Mutlaka Uygulamacı Tarafından Yapılmalıdır.

DEFLECTION LIMIT L / 200 or 15mm.
THE LINE SHOW MAXIMUM SIZES FOR THE INDICATE PRESSURE.
VERIFY THAT THE DEFLECTION OF THE SECTION IS COMPATIBLE WITH THE EMPLOYED GLASS.

DIN EN 12210 for the standard building area
Deflection limit L/200 or max. 15mm in accordance with TRLV
Differing deflection limits set by the double glazing manufacturer must be observed.
These statics diagram are intended for preliminary structural calculations and profile selection.
This is not a substitute for a final structural calculation.
Sash sizes below the line are structurally adequate.

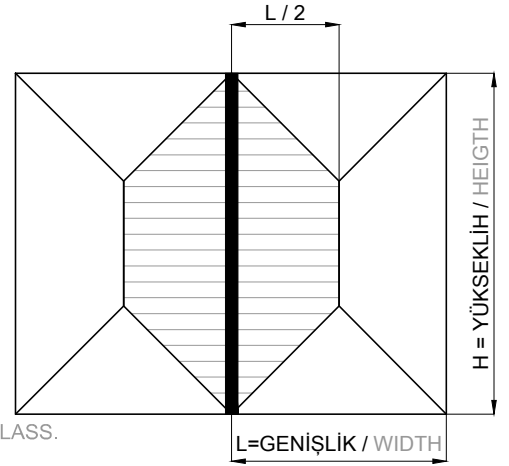
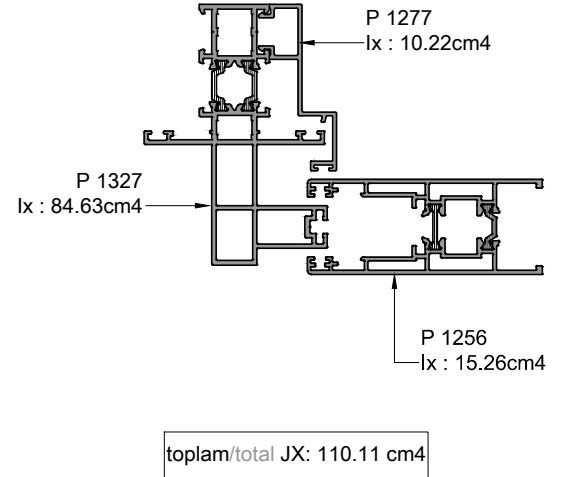

NOVA

BASİT SÜRME KAPI ve PENCERE SİSTEMİ





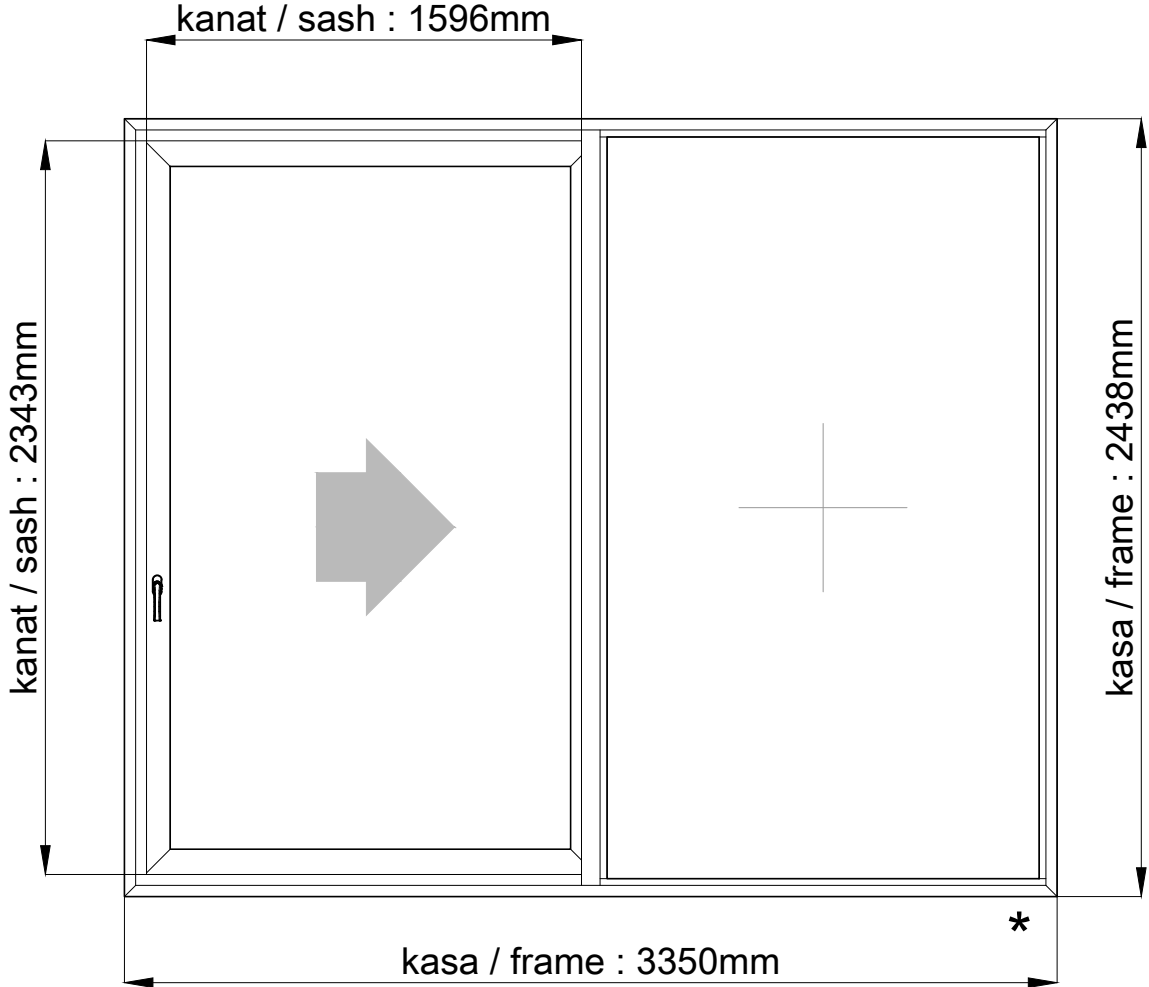

SIMPLE SLIDE DOOR and WINDOW SYSTEM





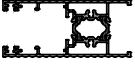
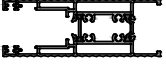
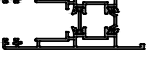
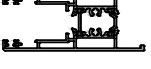

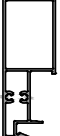
TEST ÜNİTESİ test specimen	hava geçirgenlik air permeability	su sızdırmazlık watertightness	rüzgar dayanım resist.to wind	RAPOR NO report no
	CLASS 4 600pascal EN12207	E900 900pascal EN12208	B2 800pascal EN12210	AVRASYA TTM 20-020-PR01



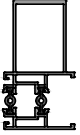
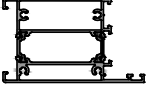





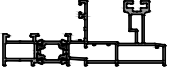

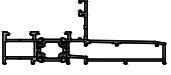

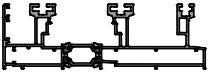
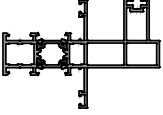

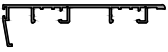
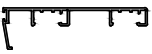

NOVA
BASİT SÜRME KAPI ve PENCERE SİSTEMİ
SIMPLE SLIDE DOOR and WINDOW SYSTEM







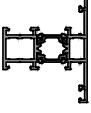
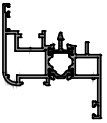
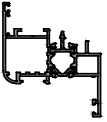

ALUMİNYUM PROFİLLER
ALUMINIUM PROFILES

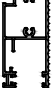
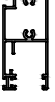
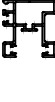









PROFİL ŞEKLİ PROFILE SECTION	PROFİL ADI PROFILE NO	KALIP KODU DIE NO	PROFİL TANIMI PROFILE DESCRIPTION	AĞIRLIK WEIGHT
	P 1254	14584 + 14584	YATAY KANAT PROFİLİ horizontal sash profile	2,255kg/mt
	P 1630	15681 + 15681	İNCE DÜŞEY KANAT PROFİLİ slim vertical sash profile	1,280kg/mt
	P 1631	15682 + 15682	İNCE YATAY KANAT PROFİLİ slim horizontal sash profile	1,545kg/mt
	P 1255	14051 + 14051	YATAY KANAT PROFİLİ horizontal sash profile	2,135kg/mt
	P 1256	14052 + 14052	KANAT PROFİLİ sash profile	1,950kg/mt
	P 1257	14053 + 14053	DÜŞEY KANAT PROFİLİ vertical sash profile	1,980kg/mt
	P 1258	14054	35mm KENET PROFİLİ 35mm interlock profile	0,895kg/mt
	P 1259	14055	35mm TAKVİYELİ KENET PROFİLİ 35mm interlock profile with reinforcement	1,605kg/mt
	P 1632	15683	28mm KENET PROFİLİ 28mm interlock profile	0,660kg/mt
	P 1633	15684	28mm TAKVİYELİ KENET PROFİLİ 28mm interlock profile with reinforcement	0,900kg/mt



PROFİL ŞEKLİ PROFILE SECTION	PROFİL ADI PROFILE NO	KALIP KODU DIE NO	PROFİL TANIMI PROFILE DESCRIPTION	AĞIRLIK WEIGHT
	P 1260	14056 + 14056	47mm KENET PROFİLİ 47mm interlock profile	1,185kg/mt
	P 1261	14056 + 14057	47mm TAKVİYELİ KENET PROFİLİ 47mm interlock profile with reinforcement	1,895kg/mt
	P 1262	14071 + 14072	GENİŞ KENET PROFİLİ wide interlock profile	2,105kg/mt
	P 1263	14073 + 14074	DAR KENET PROFİLİ slim interlock profile	1,370kg/mt
	P 1264	14077 + 14077	ÇİFT KANAT ADAPTÖR PROFİLİ double sash adapter profile	0,880kg/mt
	P 1265	14079	ÇİFT KANAT ADAPTÖR PROFİLİ double sash adapter profile	0,880kg/mt
	P 1266	14080	ÇİFT KANAT ADAPTÖR PROFİLİ double sash adapter profile	0,215kg/mt
	P 1267	14062 + 14059	İKİ RAYLI KASA PROFİLİ double track frame profile	1,910kg/mt
	P 1268	14063 + 14066	SABİT KASA PROFİLİ fixed frame profile	1,310kg/mt
	P 1269	14063 + 14064	TEK RAYLI KASA PROFİLİ single track frame profile	1,810kg/mt

PROFİL ŞEKLİ PROFILE SECTION	PROFİL ADI PROFILE NO	KALIP KODU DIE NO	PROFİL TANIMI PROFILE DESCRIPTION	AĞIRLIK WEIGHT
	P 1270	14063 + 14065	SABİT KASA PROFİLİ fixed frame profile	1,405kg/mt
	P 1271	14062 + 14060	ÜÇ RAYLI KASA PROFİLİ triple track frame profile	2,725kg/mt
	P 1272	14062 + 14061	SİNEKLİKLİ KASA PROFİLİ fly screen rail frame profile	2,455kg/mt
	P 1327	13995 + 14672	ORTADA KAYAR KANAT KASA PROFİLİ middle sash slide mullion profile	2,505kg/mt
	P 1326	14673	ORTADA KAYAR KANAT ADAPTÖR PROFİLİ middle sash slide adapter profile	1,240kg/mt
	P 1273	14050	KASA KAPATMA PROFİLİ frame closing profile	0,445kg/mt
	P 1274	14058	KASA KAPATMA PROFİLİ frame closing profile	0,515kg/mt
	P 1275	14474	KASA KAPATMA PROFİLİ frame closing profile	0,880kg/mt
	P 1276	14475	KASA KAPATMA PROFİLİ frame closing profile	0,810kg/mt
	P 1277	14067	KASA KAPATMA PROFİLİ frame closing profile	0,555kg/mt

PROFİL ŞEKLİ PROFILE SECTION	PROFİL ADI PROFILE NO	KALIP KODU DIE NO	PROFİL TANIMI PROFILE DESCRIPTION	AĞIRLIK WEIGHT
	P 1278	14068	EŞİK PROFİLİ threshold profile	0,675kg/mt
	P 1279	14069	KASA KAPATMA PROFİLİ frame closing profile	0,625kg/mt
	P 1634	15685	KENET KAPAK PROFİLİ interlock cap profile	0,435kg/mt
	P 1280	14070	KENET KAPAK PROFİLİ interlock cap profile	0,635kg/mt
	P 1281	14075	KENET KAPAK PROFİLİ interlock cap profile	0,465kg/mt
	P 1282	14076	KENET KAPAK PROFİLİ interlock cap profile	0,560kg/mt
	P 1283	14078	KENET KAPAK PROFİLİ interlock cap profile	0,390kg/mt
	P 1244	13995 + 13996	28mm ORTA KAYIT PROFİLİ 28mm mullion profile	1,530kg/mt
	P 1242	13800 + 13108	54,5mm KANAT PROFİLİ 54,5mm sash profile with pvc channel	1,715kg/mt
	P 1173	13693 + 13694	54mm KANAT PROFİLİ 54mm sash profile with euro channel	1,535kg/mt

PROFİL ŞEKLİ PROFILE SECTION	PROFİL ADI PROFILE NO	KALIP KODU DIE NO	PROFİL TANIMI PROFILE DESCRIPTION	AĞIRLIK WEIGHT
	P 1285	13183	YATAY SİNEKLİK PROFİLİ horizontal fly screen profile	0,980kg/mt
	P 1347	14577	YATAY SİNEKLİK PROFİLİ horizontal fly screen profile	0,920kg/mt
	P 1286	13136	DÜŞEY SİNEKLİK PROFİLİ vertical fly screen profile	0,725kg/mt
	P 1284	14081	SİNEKLİK ÇİFT KANAT ADAPTÖR PROFİLİ double sash adapter profile for fly screen	0,730kg/mt
	P 1020	12769	TİJ PROFİLİ (eloxal) rod profile (anodised)	0,105kg/mt
	P 1176	13698	14mm CAM ÇITASI 14mm glazing bead profile	0,335kg/mt
	P 1179	13671	18mm CAM ÇITASI 18mm glazing bead profile	0,350kg/mt
	P 1180	13670	27mm CAM ÇITASI 27mm glazing bead profile	0,380kg/mt
	P 1105	13113	22mm CAM ÇITASI 22mm glazing bead profile	0,360kg/mt
	P 1158	13111	31mm CAM ÇITASI 31mm glazing bead profile	0,365kg/mt

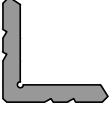
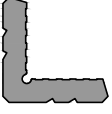
PROFİL ŞEKLİ PROFILE SECTION	PROFİL ADI PROFILE NO	KALIP KODU DIE NO	PROFİL TANIMI PROFILE DESCRIPTION	AĞIRLIK WEIGHT
	P 1494	15306	10mm CAM ÇITASI 10mm glazing bead profile	0,325kg/mt
	P 1495	15307	6mm CAM ÇITASI 6mm glazing bead profile	0,270kg/mt
	P 1496	15308	2mm CAM ÇITASI 2mm glazing bead profile	0,245kg/mt
	P 1497	15309	40mm CAM ÇITASI 40mm glazing bead profile	0,435kg/mt
	P 1498	15310	36mm CAM ÇITASI 36mm glazing bead profile	0,415kg/mt
	P 1177	12917	40mm PERVAZ PROFİLİ 40mm architrave profile	0,300kg/mt
	P 1178	13250	50mm PERVAZ PROFİLİ 50mm architrave profile	0,375kg/mt
	P 1287	11214	42mm ÇİZGİLİ PERVAZ PROFİLİ 42mm architrave profile with lines	0,360kg/mt
	P 1222	12795	68mm PERVAZ PROFİLİ 68mm architrave profile	0,760kg/mt
	P 1321	13178	20mm PERVAZ PROFİLİ 20mm architrave profile	0,160kg/mt

PROFİL ŞEKLİ PROFILE SECTION	PROFİL ADI PROFILE NO	KALIP KODU DIE NO	PROFİL TANIMI PROFILE DESCRIPTION	AĞIRLIK WEIGHT
	P 1288	14133	10mm KÖŞE TAKOZ PROFİLİ 10mm corner cleat profile	3,750kg/mt
	P 1163	4292-A	11,5mm KÖŞE TAKOZ PROFİLİ 11,5mm corner cleat profile	3,750kg/mt
	P 1016	12254	15,7mm KÖŞE TAKOZ PROFİLİ 15,7mm corner cleat profile	4,910kg/mt
	P 1118	5542	22,5mm KÖŞE TAKOZ PROFİLİ 22,5mm corner cleat profile	7,285kg/mt

NOVA
BASİT SÜRME KAPI ve PENCERE SİSTEMİ
SIMPLE SLIDE DOOR and WINDOW SYSTEM

CAM MONTAJ TALİMATI
GLAZING ASSEMBLY

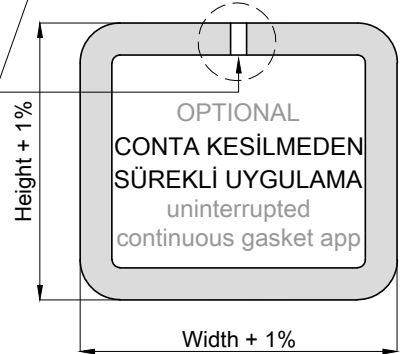
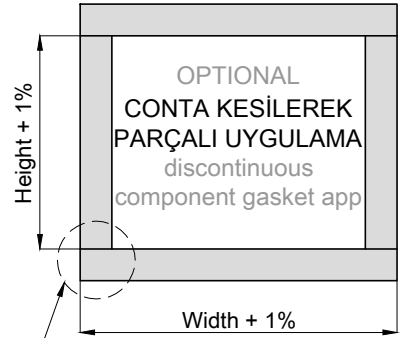
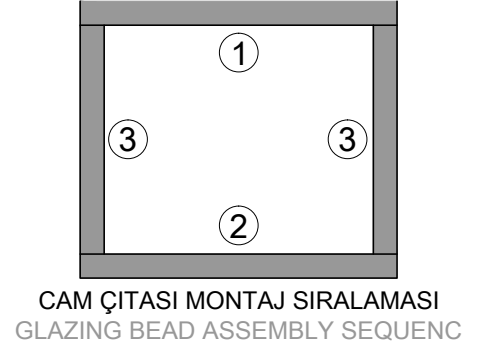
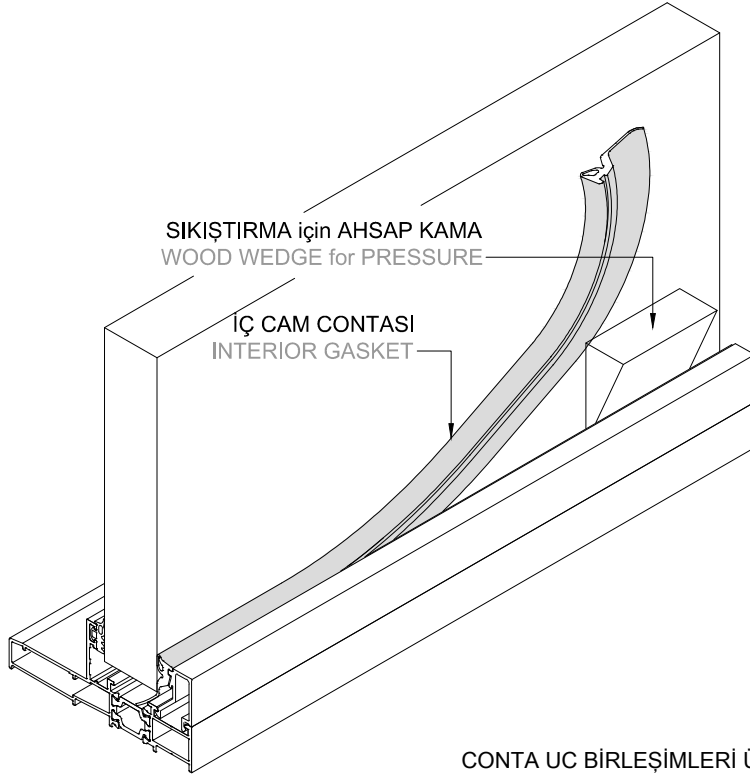

CONTA UC BİRLEŞİMLERİ ÜSTTE
OLMALI ve UYGUN MASTİK İLE
YAPIŞTIRILMALI
GASKET JOINT ON THE TOP,
BOND WITH EPDM GLUE.

① CAM TAKOZU

Cam takozları yerlesimi altta bulunan sematik çizimde gösterilmiştir.
takozların kenara mesafeleri kanat ölçüsünün 5/1 i yada 10/1 i kadar olmalıdır.
GLASS CLEATS

The assembly of glass reinforcement pieces has been showed at the top schematically. The gap distance to the corner should be, the 5/1 or 10/1 of the sash size.

② MESAFE AYARLAMA TAKOZU

Mesafe ayar takozları camın alüminyum çerçeve içinde doğru pozisyonda stabil olarak durmasını sağlar.
cam ile profil arasına takozları zorlamadan yerleştiriniz.

DISTANCE ADJUSTMENT PIECE

Distance adjustment pieces stabilize the glass in the frame at the true position. Put the distance adjustment piece between glass and profile without using force.

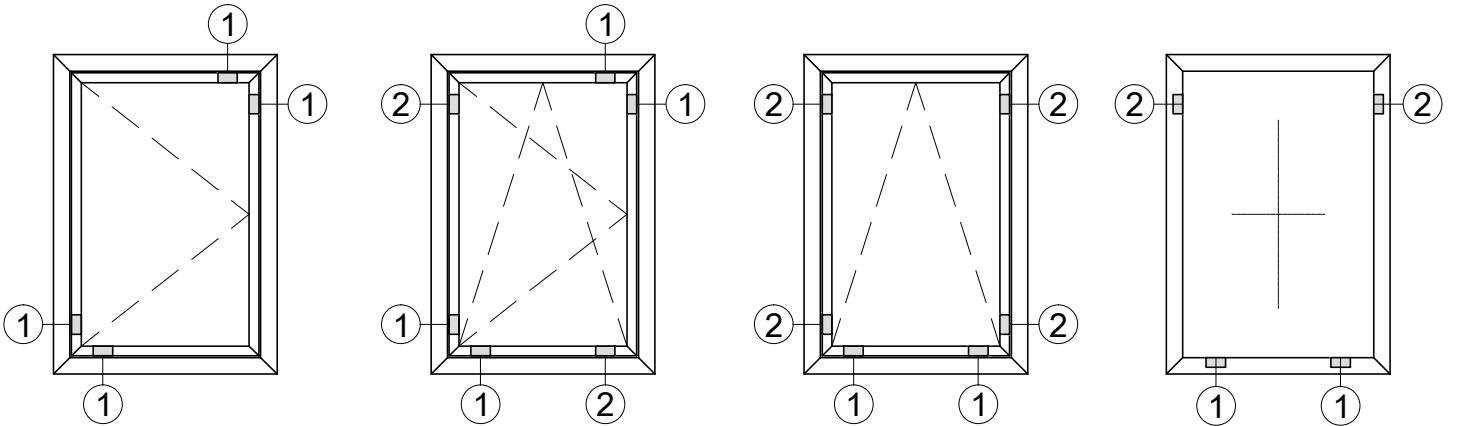

AKSESUAR ve DONANIM MONTAJINDAN ÖNCE,
CAM ve TAKOZLAMA İŞLEMİ YAPILMALIDIR.

THE PANE MUST BE SHIMMED IN THE SASH SO THAT THE SASH OPERATES WITHOUT ADJUSTMENT OF THE HARDWARE.

İÇ ve DIŞ CAM CONTALARI
interior and exterior glazing gasket

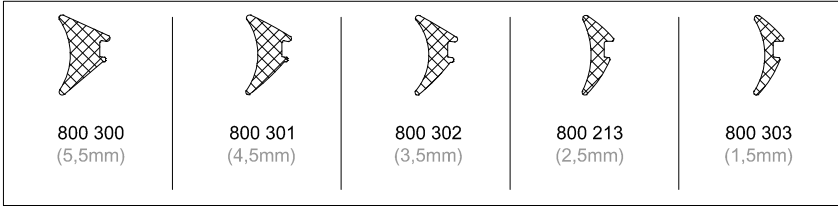

İÇ CAM CONTASI interior glazing gasket	CAM KALINLIĞI glass thickness	DIŞ CAM CONTASI interior glazing gasket
800 300 5,5mm	20mm	800 300 5,5mm
800 301 4,5mm	22mm	800 301 4,5mm
800 302 3,5mm	24mm	800 302 3,5mm
800 213 2,5mm	26mm	800 213 2,5mm
800 303 1,5mm	28mm	800 303 1,5mm

Yanda tablodaki veriler teoriktir.

Lütfen cam ve conta toleranslarını dikkate alınız.

selection tables promise a first planning.

Please keep the glass and gasket tolerances in mind.

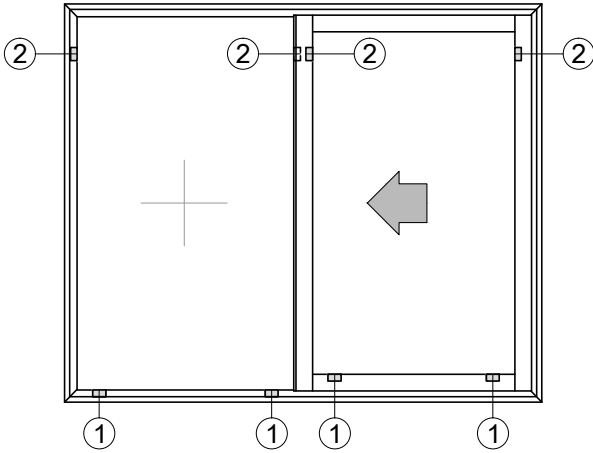

- ① TAŞIYICI TAKOZ
GLASS CLEAT
- ② AYAR TAKOZU
ADJUSTMENT PIECE

① CAM TAKOZU

Cam takozları yerleşimi altta bulunan sematik çizimde gösterilmiştir. takozların kenara mesafeleri kanat ölçüsünün 5/1 i yada 10/1 i kadar olmalıdır.

GLASS CLEATS

The assembly of glass reinforcement pieces has been showed at the top schematically. The gap distance to the corner should be, the 5/1 or 10/1 of the sash size.

② MESAFE AYARLAMA TAKOZU









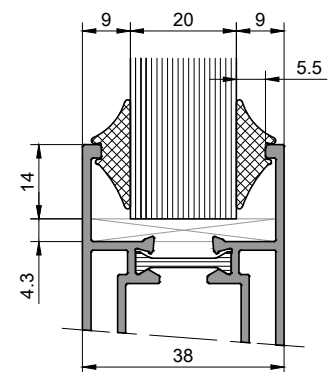
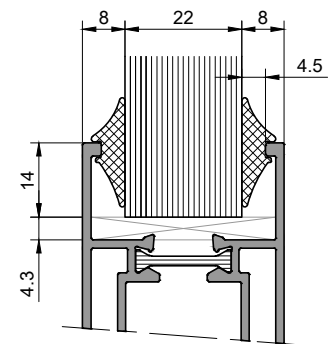
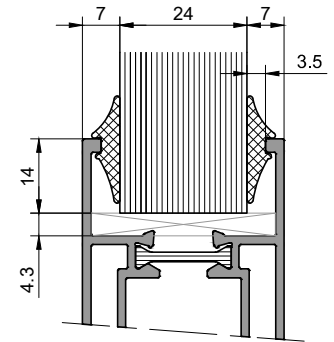
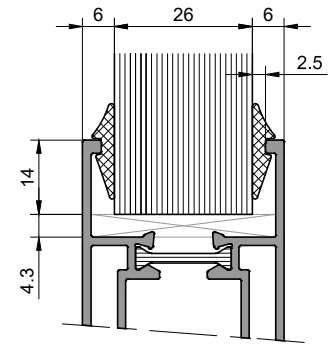
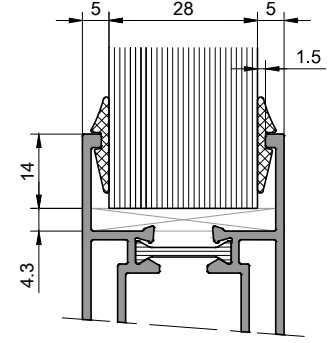

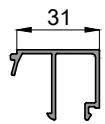
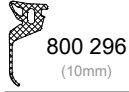
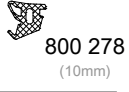
Mesafe ayar takozları camın alüminyum çerçeve içinde doğru pozisyonda stabil olarak durmasını sağlar.

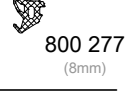
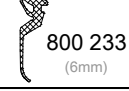
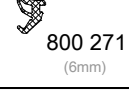
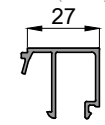
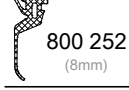
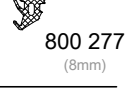
cam ile profil arasına takozları zorlamadan yerleştiriniz.

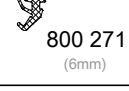
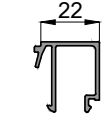
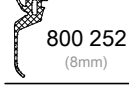
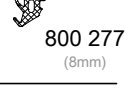
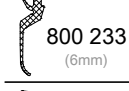
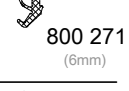
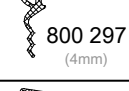
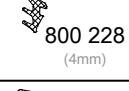
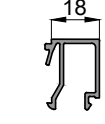
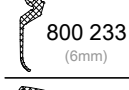
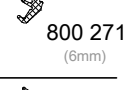
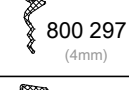
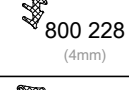
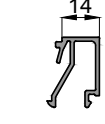
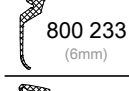
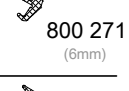
DISTANCE ADJUSTMENT PIECE

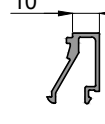

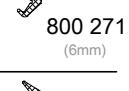
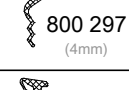
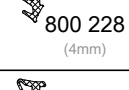
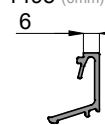
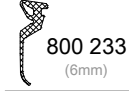
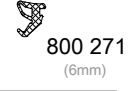

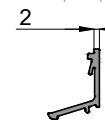
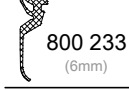
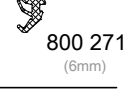
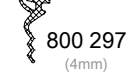
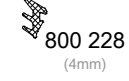

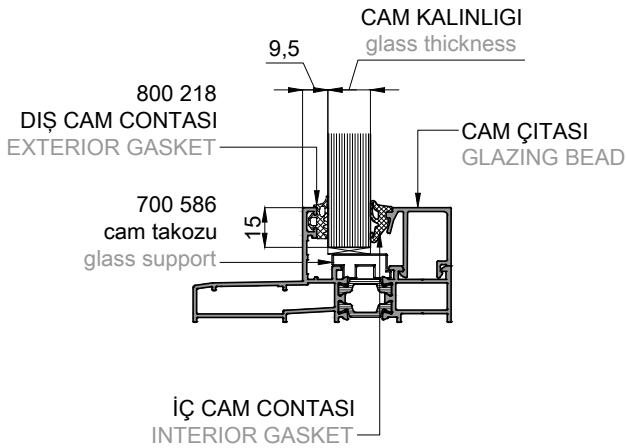



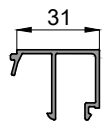
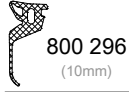
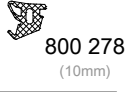

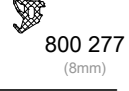
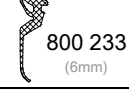
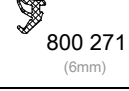
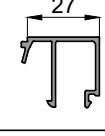
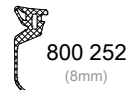
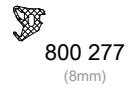
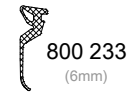
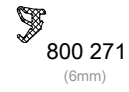
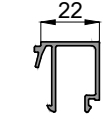

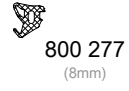
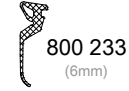
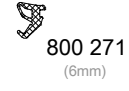
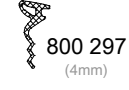
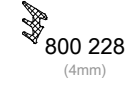
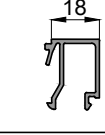
Distance adjustment pieces stabilize the glass in the frame at the true position. Put the distance adjustment piece between glass and profile without using force.

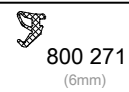

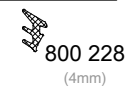
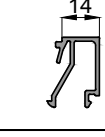
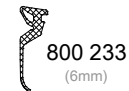
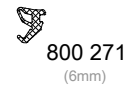
CAM KALINLIĞI glass thickness	ÇITA glazing bead		CAM CONTASI glazing gasket	
	profil section	kod code	perdeli conta with fin gasket	standart conta without fin gasket
4mm		P 1158 (31mm)	 800 296 (10mm)	 800 278 (10mm)
6mm			 800 252 (8mm)	 800 277 (8mm)
8mm			 800 233 (6mm)	 800 271 (6mm)
10mm		P 1180 (27mm)	 800 252 (8mm)	 800 277 (8mm)
12mm			 800 233 (6mm)	 800 271 (6mm)
14mm		P 1105 (22mm)	 800 252 (8mm)	 800 277 (8mm)
16mm			 800 233 (6mm)	 800 271 (6mm)
18mm			 800 297 (4mm)	 800 228 (4mm)
20mm		P 1179 (18mm)	 800 233 (6mm)	 800 271 (6mm)
22mm			 800 297 (4mm)	 800 228 (4mm)
24mm		P 1176 (14mm)	 800 233 (6mm)	 800 271 (6mm)
26mm			 800 297 (4mm)	 800 228 (4mm)
28mm		P 1494 (10mm)	 800 233 (6mm)	 800 271 (6mm)
30mm			 800 297 (4mm)	 800 228 (4mm)
32mm		P 1495 (6mm)	 800 233 (6mm)	 800 271 (6mm)
34mm			 800 297 (4mm)	 800 228 (4mm)
36mm		P 1496 (2mm)	 800 233 (6mm)	 800 271 (6mm)
38mm			 800 297 (4mm)	 800 228 (4mm)

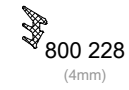
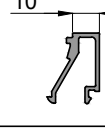
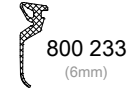
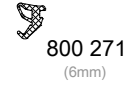
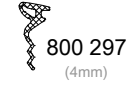
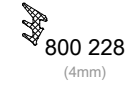

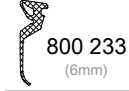
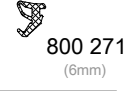
Yanda tablodaki veriler teoriktir.
Lütfen cam ve conta toleranslarını dikkate alınız.
selection tables promise a first planning.
Please keep the glass and gasket tolerances in mind.

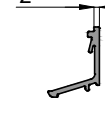
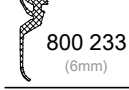
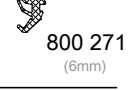
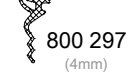
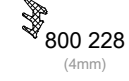
CAM KALINLIĞI glass thickness	ÇITA glazing bead		CAM CONTASI glazing gasket	
	profil section	kod code	perdeli conta with fin gasket	standart conta without fin gasket
4mm		P 1158 (31mm)	 800 296 (10mm)	 800 278 (10mm)
6mm			 800 252 (8mm)	 800 277 (8mm)
8mm			 800 233 (6mm)	 800 271 (6mm)
10mm		P 1180 (27mm)	 800 252 (8mm)	 800 277 (8mm)
12mm			 800 233 (6mm)	 800 271 (6mm)
14mm		P 1105 (22mm)	 800 252 (8mm)	 800 277 (8mm)
16mm			 800 233 (6mm)	 800 271 (6mm)
18mm			 800 297 (4mm)	 800 228 (4mm)
20mm		P 1179 (18mm)	 800 233 (6mm)	 800 271 (6mm)
22mm			 800 297 (4mm)	 800 228 (4mm)
24mm		P 1176 (14mm)	 800 233 (6mm)	 800 271 (6mm)
26mm			 800 297 (4mm)	 800 228 (4mm)
28mm		P 1494 (10mm)	 800 233 (6mm)	 800 271 (6mm)
30mm			 800 297 (4mm)	 800 228 (4mm)
32mm		P 1495 (6mm)	 800 233 (6mm)	 800 271 (6mm)
34mm			 800 297 (4mm)	 800 228 (4mm)
36mm		P 1496 (2mm)	 800 233 (6mm)	 800 271 (6mm)
38mm			 800 297 (4mm)	 800 228 (4mm)

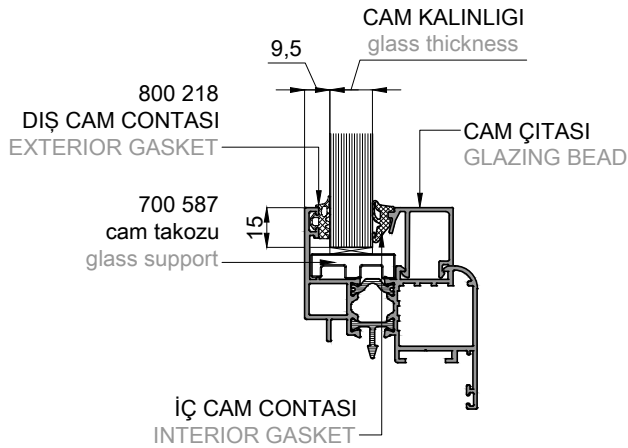













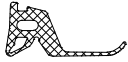

Yanda tablodaki veriler teoriktir.
Lütfen cam ve conta toleranslarını dikkate alınız.
selection tables promise a first planning.
Please keep the glass and gasket tolerances in mind.





NOVA
BASİT SÜRME KAPI ve PENCERE SİSTEMİ
SIMPLE SLIDE DOOR and WINDOW SYSTEM

CONTALAR
GASKETS

CONTA ŞEKLİ GASKET SECTION	CONTA KODU GASKET NO	MALZEME MATERIAL	CONTA TANIMI GASKET DESCRIPTION	PAKET PACKAGE
	800 213	EPDM	2,5mm İÇ ve DIŞ CAM CONTASI 2,5mm interior and exterior glazing gasket	290mt/pk 0,052kg/mt
	800 222	EPDM	ÇİFT KANAT BİRLEŞİM CONTASI double sash meeting gasket	330mt/pk 0,045kg/mt
	800 218	EPDM	DIŞ CAM CONTASI exterior glazing gasket	200mt/pk 0,072kg/mt
	800 228	EPDM	4mm İÇ CAM CONTASI 4mm interior glazing gasket	185mt/pk 0,081kg/mt
	800 233	EPDM	6mm PERDELİ İÇ CAM CONTASI 6mm interior glazing gasket	125mt/k 0,117kg/mt
	800 234	EPDM	Ø4mm YUVARLAK CONTA Ø4 oring gasket	500mt/pk 0,017kg/mt
	800 252	EPDM	8mm PERDELİ İÇ CAM CONTASI 8mm interior glazing gasket	100mt/pk 0,150kg/mt
	800 254	EPDM	KENET CONTASI interlock gasket	250mt/pk 0,050kg/mt
	800 258	EPDM	KANAL KAPATMA CONTASI channel closing gasket	450mt/pk 0,036kg/mt
	800 270	EPDM	ORTA SIZDIRMAZLIK CONTASI central tightness gasket	70mt/pk 0,205kg/mt



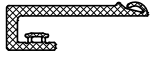



CONTA ŞEKLİ GASKET SECTION	CONTA KODU GASKET NO	MALZEME MATERIAL	CONTA TANIMI GASKET DESCRIPTION	PAKET PACKAGE
	800 271	EPDM	6mm İÇ CAM CONTASI 6mm interior glazing gasket	185mt/pk 0,081kg/mt
	800 272	EPDM	PERVAZ BİNİ CONTASI overlap gasket for architrave	415mt/pk 0,036kg/mt
	800 277	EPDM	8mm İÇ CAM CONTASI 8mm interior glazing gasket	165mt/pk 0,092kg/mt
	800 278	EPDM	10mm İÇ CAM CONTASI 10mm interior glazing gasket	115mt/pk 0,130kg/mt
	800 296	EPDM	10mm PERDELİ İÇ CAM CONTASI 10mm interior glazing gasket	90mt/pk 0,165kg/mt
	800 297	EPDM	4mm PERDELİ İÇ CAM CONTASI 4mm interior glazing gasket	160mt/pk 0,092kg/mt
	800 300	EPDM	5,5mm İÇ ve DIŞ CAM CONTASI 5,5mm interior and exterior glazing gasket	165mt/pk 0,090kg/mt
	800 301	EPDM	4,5mm İÇ ve DIŞ CAM CONTASI 4,5mm interior and exterior glazing gasket	195mt/pk 0,077kg/mt
	800 302	EPDM	3,5mm İÇ ve DIŞ CAM CONTASI 3,5mm interior and exterior glazing gasket	235mt/pk 0,064kg/mt
	800 303	EPDM	1,5mm İÇ ve DIŞ CAM CONTASI 1,5mm interior and exterior glazing gasket	350mt/pk 0,043kg/mt

CONTA ŞEKLİ GASKET SECTION	CONTA KODU GASKET NO	MALZEME MATERIAL	CONTA TANIMI GASKET DESCRIPTION	PAKET PACKAGE
	800 304	EPDM	KANAL KAPATMA CONTASI channel closing gasket	390mt/pk 0,033kg/mt
	800 305	EPDM	ÇİFT KANAT BİRLEŞİM CONTASI double sash meeting gasket	185mt/pk 0,080kg/mt
	800 306	EPDM	ÇİFT KANAT BİRLEŞİM CONTASI double sash meeting gasket	127mt/pk 0,118kg/mt
	800 307	EPDM	KANAL KAPATMA CONTASI channel closing gasket	185mt/pk 0,083kg/mt
	800 308	EPDM	ÇİFT KANAT BİRLEŞİM CONTASI double sash meeting gasket	240mt/pk 0,050kg/mt
	800 309	EPDM	TEK RAYLI KASA YALITIM CONTASI single track rail frame insulating gasket	165mt/pk 0,091kg/mt
	800 310	Polipropylene	FİRÇA FİTİL brush gasket	350mt/pk
	800 311	TPE	BALON CONTA baloon gasket	300mt/pk 0,022kg/mt
	800 312 ST G 2011	EPDM	SİNEKLİK TELİ MONTAJ CONTASI fly screen assembly gasket	500mt/pk 0,022kg/mt
	800 313	Polipropylene	FİRÇA FİTİL brush gasket	350mt/pk

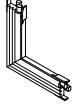



CONTA ŞEKLİ GASKET SECTION	CONTA KODU GASKET NO	MALZEME MATERIAL	CONTA TANIMI GASKET DESCRIPTION	PAKET PACKAGE
	800 331	EPDM	DIŞ BİNİ CONTASI exterior overlap gasket	285mt/pk 0,035kg/mt
	800 332	EPDM	İÇ BİNİ CONTASI interior overlap gasket	370mt/pk 0,027kg/mt
	800 430	EPDM	KENET YALITIM CONTASI interlock isolation gasket	75mt/pk 0,201kg/mt
	800 431	EPDM	KALDIR-SÜR BİNİ CONTASI lift&slide side overlap gasket	433mt/pk 0,030kg/mt
	QL 69750	QLON	QLON CONTA QLON GASKET (beyaz/white ral 9003 (siyah/black ral 9005) (gümüş gri/silver grey ral 7001) talep üzerine diğer renkler other colours upon request	500mt/pk 200mt X2pcs

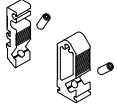
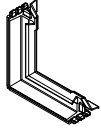

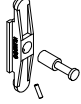
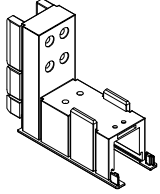
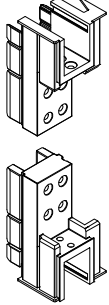
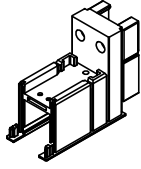
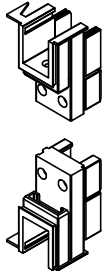

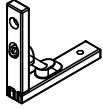
NOVA
BASİT SÜRME KAPI ve PENCERE SİSTEMİ
SIMPLE SLIDE DOOR and WINDOW SYSTEM

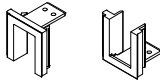



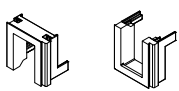
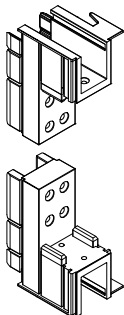
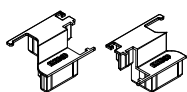
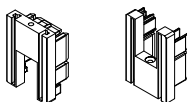

AKSESUARLAR
ACCESSORIES

AKSESUAR ŞEKLİ ACCESSORIES SHAPE	AKSESUAR ACCESS. NO	AKSESUAR TANIMI ACCESSORIES DESCRIPTION	MİKTAR QUANTITY
	700 303	PVC KÖŞE ONBAŞI pvc corner angle for architrave	500 adet/pieces
	700 305	DIŞ CAM CONTASI İÇİN KÖŞE VULKANİZE vulcanized corner for ext.glazing gasket	50 adet/pieces
	700 322	ALUMİNYUM SIKIŞTIRMALI ONBAŞI aluminium corner with alien key	250 adet/pieces
	700 328	İNOX RAY stainless steel rail	30mt (3mt X 10pcs)
	700 329	KANAT İÇİN ALUMİNYUM ONBAŞI aluminum corner angle for sash	500 adet/pieces
	700 331	KANAT İÇİN ALUMİNYUM ONBAŞI aluminum corner angle for sash	500 adet/pieces
	700 334	KASA İÇİN PVC ONBAŞI pvc corner angle for sash and frame	500 adet/pieces
	700 356	KANAT İÇİN ALUMİNYUM ONBAŞI aluminum corner angle for sash	500 adet/pieces
	700 403	ORTA KAYIT T BİRLEŞİM ÖN ve ARKA PARÇASI T connecting bracket for mullion	50 çift/pair
	700 405	ORTA SIZDIRMAZLIK CONTASI İÇİN KÖŞE VULKANİZE vulcanized corner for central gasket	50 adet/pieces

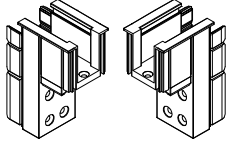
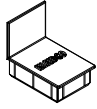
AKSESUAR ŐEKLİ ACCESSORIES SHAPE	AKSESUAR ACCESS. NO	AKSESUAR TANIMI ACCESSORIES DESCRIPTION	MİKTAR QUANTITY
	700 411	KİLİT KARŐILIGI keeper	25 adet/pieces
	700 412	TİJLİ SİSTEM KİLİTLEME AKSESUARI locking device for polyamide rod	25 adet/pieces
	700 413	KÖŐE BİRLEŐİM PVC TAKOZU corner assembly block for sash	25 adet/pieces
	700 414	37mm KENET İÇİN KÖŐE BİRLEŐİM PVC TAKOZU corner assembly block for 27mm interlock	25 çift/pair
	700 680	İNCE KANAT İÇİN KÖŐE BİRLEŐİM PVC TAKOZU corner assembly block for slim sash	25 çift/pair
	700 681	28mm KENET İÇİN KÖŐE BİRLEŐİM PVC TAKOZU corner assembly block for 28mm interlock	25 çift/pair

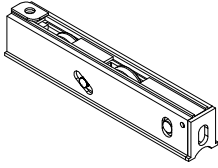

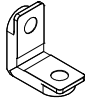
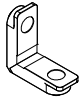
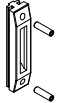

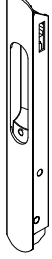
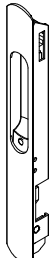
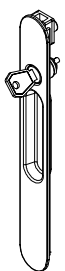
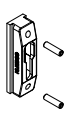
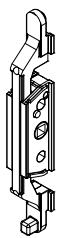
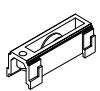

AKSESUAR ŐEKLİ ACCESSORIES SHAPE	AKSESUAR ACCESS. NO	AKSESUAR TANIMI ACCESSORIES DESCRIPTION	MİKTAR QUANTITY
	700 682	28mm KENET İÇİN KÖŐE BİRLEŐİM PVC TAKOZU corner assembly block for 28mm interlock	25 çift/pair
	700 683	KANAT İÇİN PVC ONBAŐI plastic corner angle for sash	100 adet/pieces
	700 684	İNCE KANAT İÇİN CIVATALI PVC KÖŐE TAKOZU corner assembly block for slim interlock	100 adet/pieces
	700 415	ALT ve ÜŐT KENET KAPAGI top and bottom cap plug for interlock	25 çift/pair
	700 416	47mm KENET İÇİN KÖŐE BİRLEŐİM PVC TAKOZU corner assembly block for 47mm interlock	25 çift/pair
	700 417	KANAT İÇİN PVC ONBAŐI plastic corner angle for sash	500 adet/pieces
	700 418	GENİŐ KENET EK PVC ADAPTÖRÜ additional pvc plug for wide interlock	25 çift/pair
	700 419	TAKVİYELİ KENET PROFİLİ ALT ve ÜŐT KAPAGI pvc cap plug for reinforcement interlock	50 adet/pieces
	700 420	TAKVİYELİ KENET PROFİLİ ALT ve ÜŐT KAPAGI pvc cap plug for reinforcement interlock	50 adet/pieces



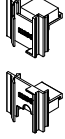
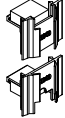

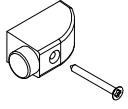
AKSESUAR ŐEKLİ ACCESSORIES SHAPE	AKSESUAR ACCESS. NO	AKSESUAR TANIMI ACCESSORIES DESCRIPTION	MİKTAR QUANTITY
	700 421	TAKVİYELİ KENET PROFİLİ ALT ve ÜST KAPAGI pvc cap plug for reinforcement interlock	50 adet/pieces
	700 422	ÇİFT KANAT ADAPTÖR PROFİLİ KAPAGI pvc cap plug for double sash adapter profile	25 adet/pieces
	700 423	KANAT İÇİN PVC ONBAŐI plastic corner angle for sash	500 adet/pieces
	700 424	KANAT İÇİN PVC ONBAŐI plastic corner angle for sash	500 adet/pieces
	700 425	EKSENEL KOL ve TİJ BAĞLANTI PABUCU pvc adapter plug for axial handle	50 adet/pieces
	700 426	DAR KENET EK PVC ADAPTÖRÜ additional pvc plug for slim interlock	25 çift/pair
	700 427	47mm KENET İÇİN KÖŐE BİRLEŐİM PVC TAKOZU 47mm interlock corner joint assembly pvc block	25 çift/pair
	700 428	ÇİFT KANAT ADAPTÖR PROFİLİ KAPAGI pvc cap plug for double sash adapter profile	25 çift/pair
	700 429	47mm KENET İÇİN KÖŐE BİRLEŐİM PVC TAKOZU 47mm interlock corner joint assembly pvc block	25 çift/pair

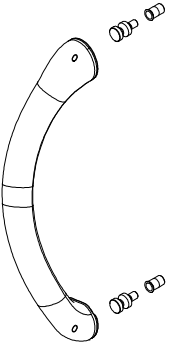
AKSESUAR ŐEKLİ ACCESSORIES SHAPE	AKSESUAR ACCESS. NO	AKSESUAR TANIMI ACCESSORIES DESCRIPTION	MİKTAR QUANTITY
	700 430	47mm KENET İÇİN KÖŐE BİRLEŐİM PVC TAKOZU 47mm interlock corner joint assembly pvc block	25 çift/pair
	700 431	TAKVİYELİ KENET PROFİLİ ALT ve ÜŐT KAPAGI pvc cap plug for reinforcement interlock	50 adet/pieces
	700 432	ALUMİNYUM SIKIŐTIRMALI ONBAŐI aluminium corner with alien key	50 adet/pieces
	700 433	AYARLI RULMAN adjustable roller	50 adet/pieces
	700 434	SİNEKLİK ALT-ÜŐT KILAVUZ top and bottom guide for fly screen	50 adet/pieces
	700 435	BUTONLU KÖŐE TAKOZU (10x25 button corner for fly screen)	50 adet/pieces
	700 436	BUTONLU KÖŐE TAKOZU (10x19 button corner for fly screen)	50 adet/pieces
	700 437	KİLİT KARŐILIGI keeper for pool handle	25 adet/pieces
	700 438	ÇELİK DİL locking device for pool handle	100 adet/pieces

AKSESUAR ŐEKLİ ACCESSORIES SHAPE	AKSESUAR ACCESS. NO	AKSESUAR TANIMI ACCESSORIES DESCRIPTION	MİKTAR QUANTITY
	700 439	OTOMATİK KOL (Standart renk : siyah) (Tüm Ral renkleri - min.miktar :1000ad) automatic spring handle (standart color : black) (for all Ral color - min.quantity :1000pcs.)	25 adet/pieces
	700 440	EL İLE KUMANDALI KOL (Standart renk : siyah) (Tüm Ral renkleri - min.miktar :1000ad) manuel control handle (standart color : black) (for all Ral color - min.quantity :1000pcs.)	25 adet/pieces
	700 441	ANAHTAR KİLİTLİ KOL (Standart renk : siyah) (Tüm Ral renkleri - min.miktar :1000ad) key locking handle (standart color : black) (for all Ral color - min.quantity :1000pcs.)	25 adet/pieces
	700 442	PVC İSPANYOLET KİLİT KARŐILIGI keeper for 16mm pvc espagnolettes	25 adet/pieces
	700 443	TİJLİ SİSTEM İÇİN KİLİT MEKANİZMASI gear box device for multipoint locking	25 adet/pieces
	700 444	SİNEKLİK İÇİN RULMAN roller for fly screen	50 adet/pieces

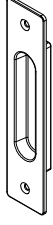
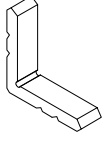
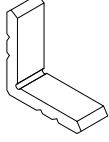

AKSESUAR ŞEKLİ ACCESSORIES SHAPE	AKSESUAR ACCESS. NO	AKSESUAR TANIMI ACCESSORIES DESCRIPTION	MİKTAR QUANTITY
	700 445	ALT ve ÜST SIZDIRMAZLIK tightness plug for single track rail	25 adet/pieces
	700 446	ALT ve ÜST SIZDIRMAZLIK tightness plug for single track rail	25 adet/pieces
	700 447	ALT ve ÜST SIZDIRMAZLIK tightness plug for double-triple track rail	25 adet/pieces
	700 448	ALT ve ÜST SIZDIRMAZLIK tightness plug for double-triple track rail	25 adet/pieces
	700 449	ALT ve ÜST SIZDIRMAZLIK tightness plug for double-triple track rail	25 adet/pieces
	700 451	SU TAHLİYE KAPAGI weep hole cap	50 adet/pieces
	700 452	ÇİFT KANAT ADAPTÖR PROFİLİ KAPAGI pvc cap plug for double sash adapter profile	25 çift/pair
	700 454	KANAT SABİTLEME ALT TAKOZU bottom fixation block for fixed sash	25 adet/pieces
	700 455	KANAT SABİTLEME ALT TAKOZU side fixation block for fixed sash	25 adet/pieces
	700 456	KANAT SABİTLEME ALT TAKOZU top fixation block for fixed sash	25 adet/pieces

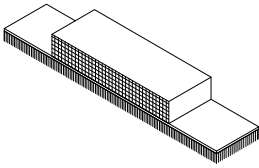
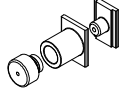
AKSESUAR ŐEKLİ ACCESSORIES SHAPE	AKSESUAR ACCESS. NO	AKSESUAR TANIMI ACCESSORIES DESCRIPTION	MİKTAR QUANTITY
	700 457	DIŐ-SAG KANAT ALT ÜST KAPAK SETİ top&bottom cap plug for outside-right sash	25 çift/pair
	700 458	DIŐ-SOL KANAT ALT ÜST KAPAK SETİ top&bottom cap plug for outside-left sash	25 çift/pair
	700 459	KANAT SALLANTI ENGELLEME TAKOZU anti swing block for sash	100 adet/pieces
	700 473	KANAT STOPERİ bumper	50 adet/pieces
	700 479	ALUMİNYUM KÖŐE ONBAŐI aluminum corner angle for architrave	100 adet/pieces
	700 482	SABİT D KOL (Standart renk : siyah) (Tüm Ral renkleri - min.miktar :1000ad) fixed D handle (standart color : black) (for all Ral color - min.quantity :1000pcs.)	50 adet/pieces
	700 493	KÜÇÜK HAVUZ KOL (Standart renk : siyah) (Tüm Ral renkleri - min.miktar :1000ad) small pool handle (standart color : black) (for all Ral color - min.quantity :1000pcs.)	50 adet/pieces

AKSESUAR ŐEKLİ ACCESSORIES SHAPE	AKSESUAR ACCESS. NO	AKSESUAR TANIMI ACCESSORIES DESCRIPTION	MİKTAR QUANTITY
	700 494	BÜYÜK HAVUZ KOL (Standart renk : siyah) (Tüm Ral renkleri - min.miktar :1000ad) big pool handle (standart color : black) (for all Ral color - min.quantity :1000pcs.)	50 adet/pieces
	700 495	KÖŐE TAKOZU (19mm) corner cleat (19mm)	50 adet/pieces
	700 496	KÖŐE TAKOZU (25mm) corner cleat (25mm)	50 adet/pieces
	700 497	TEK RAYLI KASA ORTA KAYIT ADAPTÖR TAPASI (ortada,dıŐta alıŐan kanat ile kullanılır)	50 adet/pieces
	700 510	HAVUZ KOL OK NOKTA KİLİTLEME KANCASI locking device for multipoint locking with pool handle	50 adet/pieces
	700 511	LIFT & SLIDE KANAT İİN AKSESUAR MONTAJ LAMASI aluminum rod profile for lift&slide accessories assembly	50cmX20ad. 50cmX20pcs
	700 512	LIFT & SLIDE ÜŐT SIZDIRMAZLIK tightness plug for lift&slide double-triple track rail	50 adet/pieces
	700 513	KANAT İİ GİZLİ STOPER hidden bumper for inside of the sash	50 adet/pieces

NOVA
BASİT SÜRME KAPI ve PENCERE SİSTEMİ
SIMPLE SLIDE DOOR and WINDOW SYSTEM

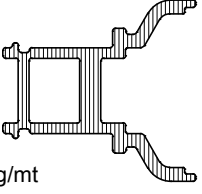
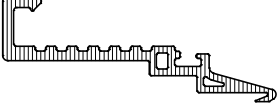
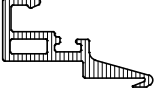
PLASTİK PROFİLLER
PVC PROFILES

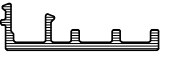
PROFİL ŞEKLİ PROFILE SECTION	PROFİL KODU PROFILE NO	MALZEME MATERIAL	PROFİL TANIMI PROFILE DESCRIPTION	PAKET PACKAGE
 0,144kg/mt	600 416	PVC	KASA İÇİ U KANAL PROFİLİ pvc U channel for frame	6mt 25ad/pk
 0,320kg/mt	600 417	PVC	İSPANYOLET KANAL PROFİLİ channel for espagnolette	6mt 25ad/pk
 0,211kg/mt	600 418	PVC	GENİŞ PVC KENET PROFİLİ pvc interlock for wide sash	6mt 25ad/pk
 0,133kg/mt	600 419	PVC	DAR PVC KENET PROFİLİ pvc interlock for slim sash	6mt 25ad/pk
 0,079kg/mt	600 420	PVC	CAM ÇITA PROFİLİ pvc glazing bead profile	6mt 25ad/pk
 0,070kg/mt	600 429	POLYAMİD	POLYAMİD TİJ PROFİLİ polyamide rod profile	6mt 25ad/pk
 0,100kg/mt	600 435	PVC	LIFT&SLIDE KANAT ARABA BESLEME PROFİLİ additional plastic profile for lift&slide roller set	6mt 25ad/pk

NOVA
BASİT SÜRME KAPI ve PENCERE SİSTEMİ
SIMPLE SLIDE DOOR and WINDOW SYSTEM

UYGULANABİLİR AÇILIM TİPLERİ
APPLICABLE OPENING TIPOLOGIES

TİP - 1 :
tek raylı kasa,tek kanat kayar,
tek sabit camlı
single track,one sash slide,
one fix glass

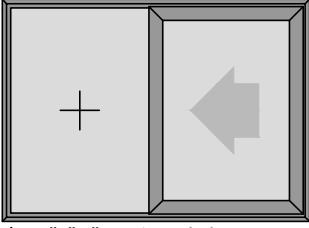

1

dış görünüş-external view



TİP - 2 :
tek raylı kasa,tek kanat kayar,
tek sabit camlı,üstte sabit pencere
single track,one sash slide,one fix glass,
fix window above

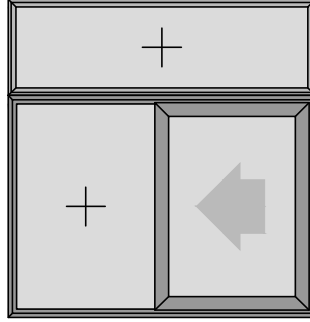

2

dış görünüş-external view

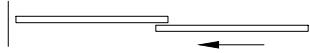

TİP - 3 :
tek raylı kasa,tek kanat kayar,
tek sabit camlı,altta sabit pencere
single track,one sash slide,one fix glass,
fix window bottom

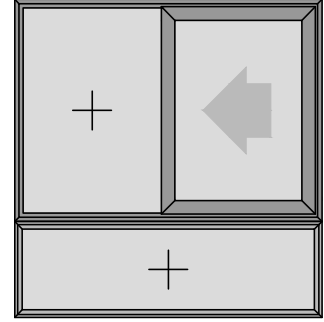

3

dış görünüş-external view

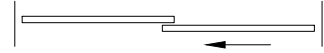

TİP - 4 :
tek raylı kasa,çift kanat kayar,çift sabit camlı
single tracks,two sashes slide,two fix glasses

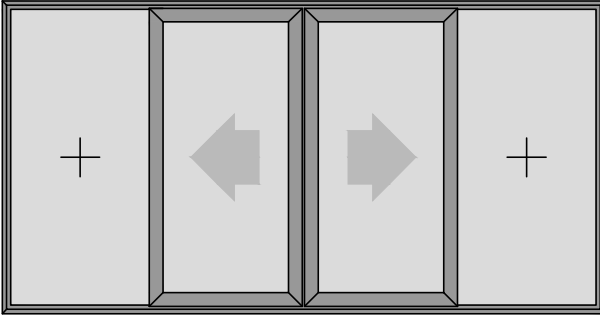

4

dış görünüş-external view

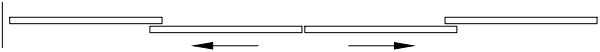

TİP - 5 :
tek raylı kasa,çift kanat kayar,ortada tek sabit camlı
single tracks,two sashes slide,single fix glass in the middle

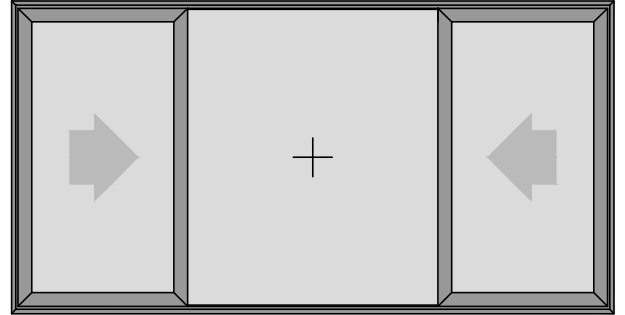

5

dış görünüş-external view



TİP - 6 :
tek raylı kasa,çift kanat kayar,çift sabit camlı,altta sabit pencere
single tracks,two sashes slide,two fix glasses,fix window bottom

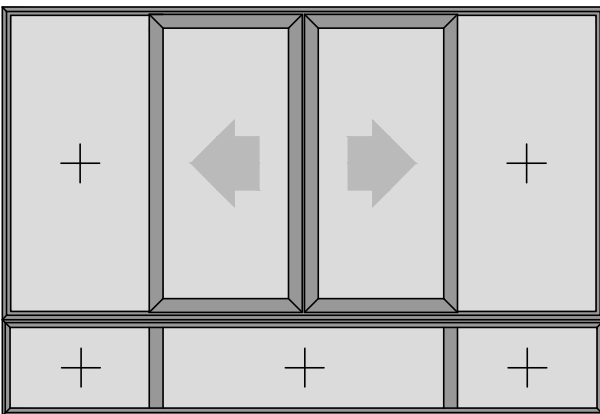

6

dış görünüş-external view



TİP - 7 :
tek raylı kasa,çift kanat kayar,ortada tek sabit camlı,üstte sabit pencere
single tracks,two sashes slide,single fix glass in the middle,fix window top

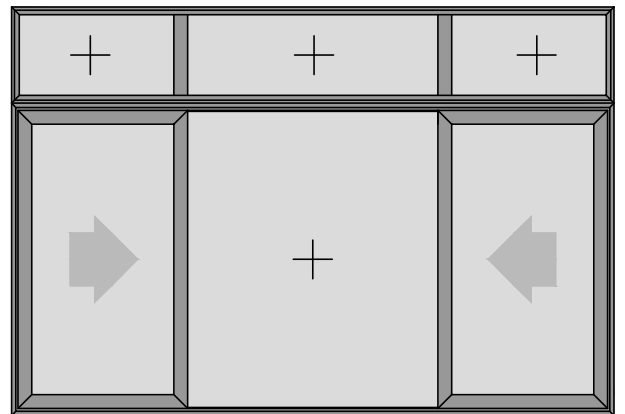

7

dış görünüş-external view

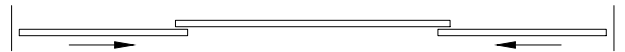

TİP - 8 :
tek raylı kasa,tek kanat kayar,
çift açılım pencere
single track,one sash slide,
double opening window

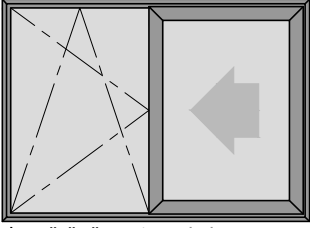

8

dış görünüş-external view

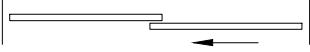

TİP - 9 :
tek raylı kasa,tek kanat kayar,
çift açılım pencere,üste vasistas pencere
single track,one sash slide,
double opening window,
bottom hung window top

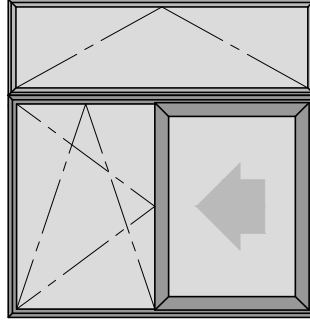

9

dış görünüş-external view

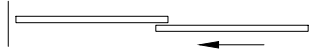

TİP - 10 :
tek raylı kasa,tek kanat kayar,
çift açılım pencere,altta vasistas pencere
single track,one sash slide,
double opening window,
bottom hung window bottom

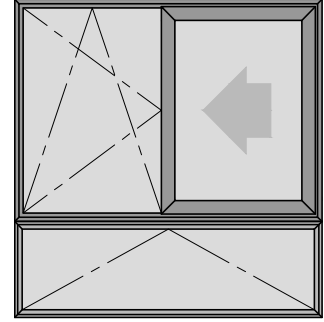

10

dış görünüş-external view

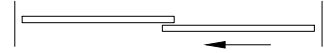

TİP - 11 :
tek raylı kasa,çift kanat kayar,çift açılım pencere
single track,double sash slide,double opening window

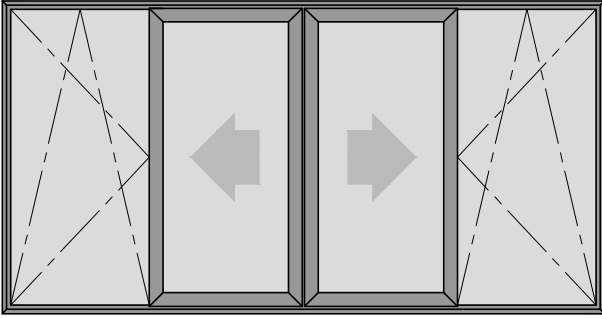

11

dış görünüş-external view



TİP - 12 :
tek raylı kasa,çift kanat kayar,çift açılım pencere
single track,double sash slide,double opening window

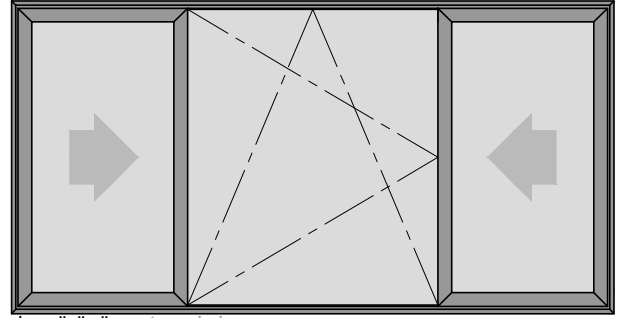

12

dış görünüş-external view



TİP - 13 :
tek raylı kasa,tek kanat kayar,çift açılım pencere,altta vasistas
pencere
single track,one sash slide,double opening window,bottom hung
window bottom

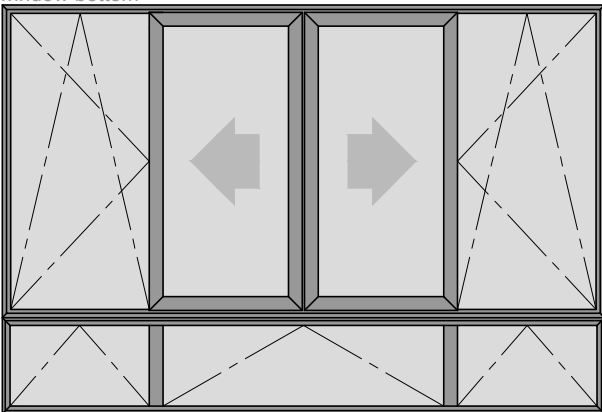

13

dış görünüş-external view



TİP - 14 :
tek raylı kasa,tek kanat kayar,çift açılım pencere,üste vasistas
pencere
single track,one sash slide,double opening window,bottom hung
window top

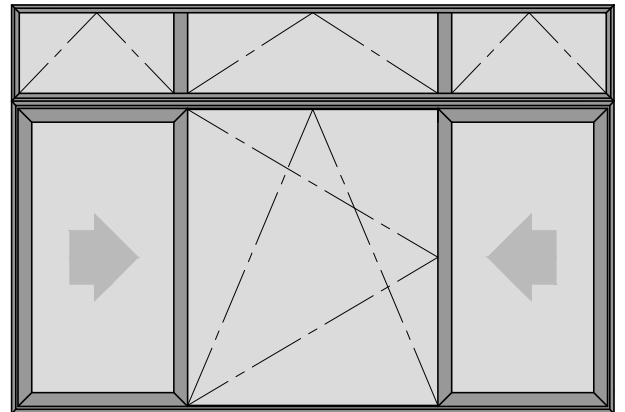

14

dış görünüş-external view

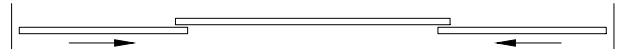

TİP - 15 :
tek raylı kasa,çift kanat kayar,çift açılım pencere,altta vasistas
pencere
single track,double sash slide,double opening window,
bottom hung window bottom

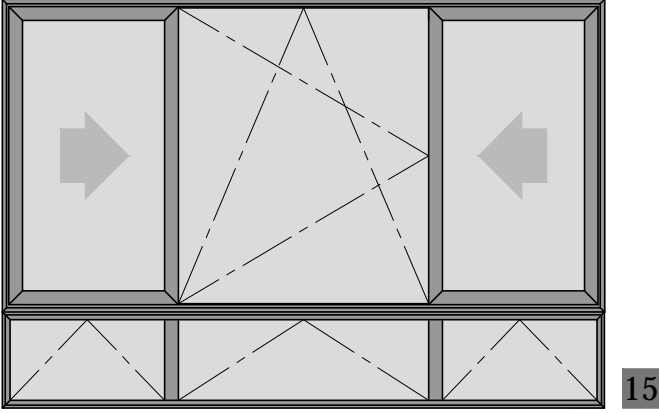

dış görünüş-external view

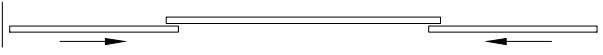

TİP - 16 :
tek raylı kasa,tek kanat kayar,çift sabit camlı,
altta sabit cam ve vasistas pencere
single track,single sash slide,double fix window,
single bottom hung window,double fix window bottom

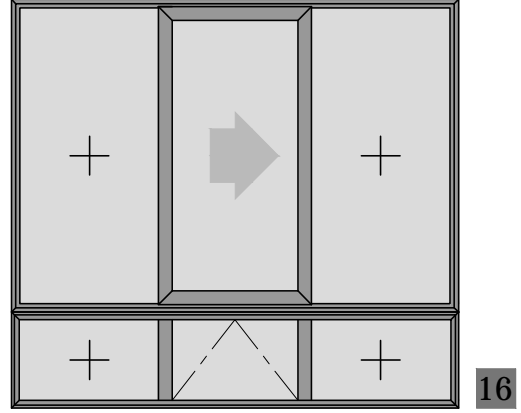

dış görünüş-external view

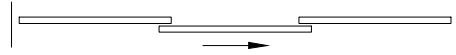

TİP - 17 :
tek raylı kasa,çift kanat kayar,ortada tek sabit camlı,altta sabit pencere
single tracks,two sashes slide,single fix glass in the middle,fix window bottom

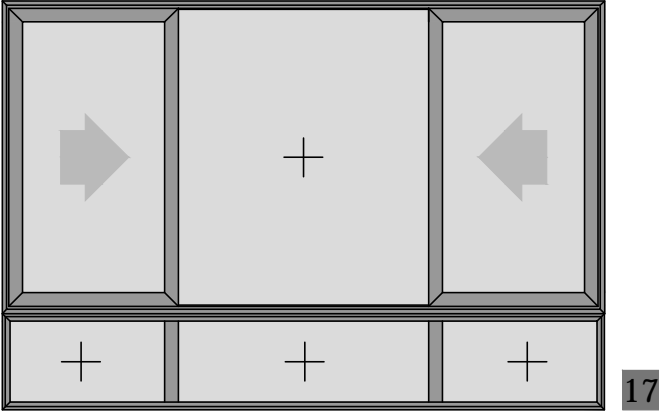

dış görünüş-external view

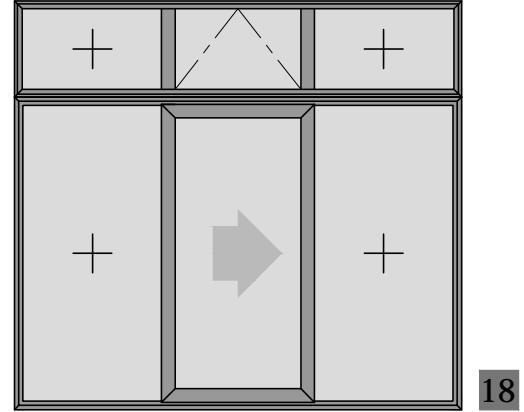
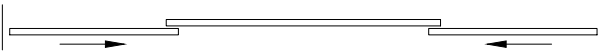

dış görünüş-external view

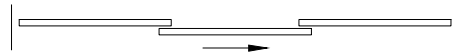

TİP - 19 :
tek raylı kasa,tek kanat kayar,çift sabit camlı
single track,single sash slide,double fix window

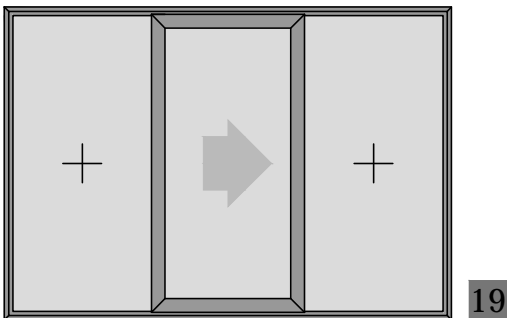

dış görünüş-external view

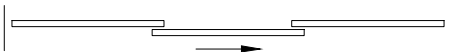

TİP - 18 :
tek raylı kasa,tek kanat kayar,çift sabit camlı,üstte sabit cam ve
vasistas pencere
single track,single sash slide,double fix window,single bottom hung
window bottom,double fix window

TİP - 20 :
çift raylı kasa,çift kanat kayar
double tracks,double sash slide

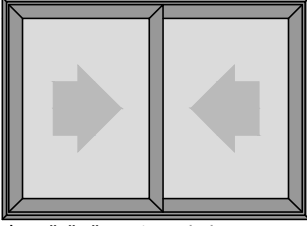

20

dış görünüş-external view



TİP - 21 :
çift raylı kasa,tek kanat kayar,
tek kanat sabit,
double tracks,single sash slide,
single sash fix

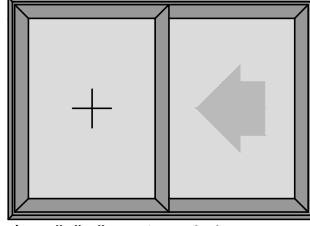

21

dış görünüş-external view



TİP - 22 :
çift raylı kasa,tek kanat kayar,
tek sabit camlı,altta sabit pencere,
double tracks,one sash slide,one fix sash,
fix window bottom

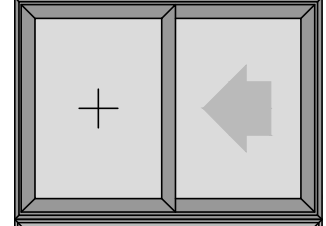

22

dış görünüş-external view



TİP - 23 :
çift raylı kasa,çift kanat kayar,
altta sabit pencere,
double tracks,two sashes slide,
fix window top

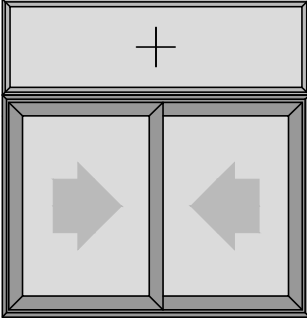

23

dış görünüş-external view



TİP - 24 :
çift raylı kasa,dört kanat kayar,
double tracks,four sashes slide,

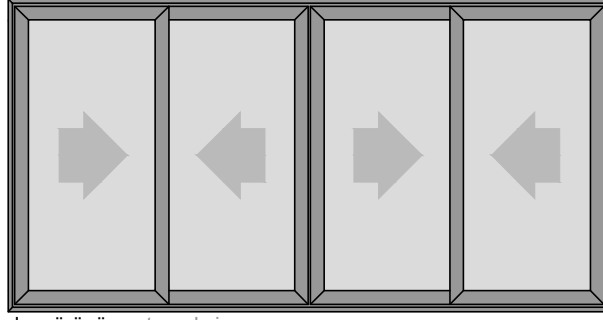

24

dış görünüş-external view



TİP - 25 :
çift raylı kasa,çift kanat kayar,çift kanat sabit,
double tracks,two sashes slide,two sashes fix

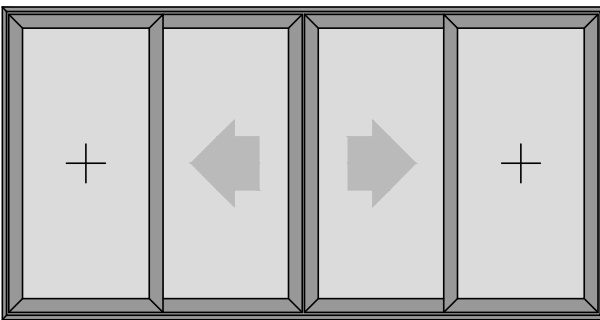

25

dış görünüş-external view



TİP - 26 :
çift raylı kasa,çift kanat kayar,
üste vasistas pencere
double tracks,double sash slide,
bottom hung window above

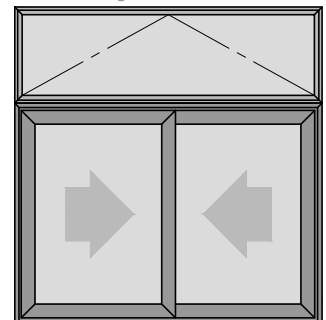

26

dış görünüş-external view

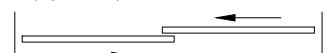

TIP - 27 :
çift raylı kasa,ortada tek kanat sabit,çift kanat kayar,
double tracks,one sash fix in the middle,two sashes slide,

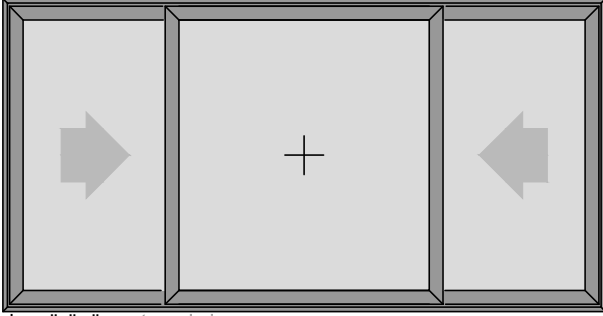

27

dış görünüş-external view

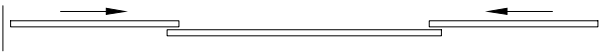

TIP - 28 :
çift raylı kasa,tek kanat kayar,
tek sabit camlı,altta vasistas pencere,
double tracks,one sash slide,one fix sash,
bottom hung window bottom

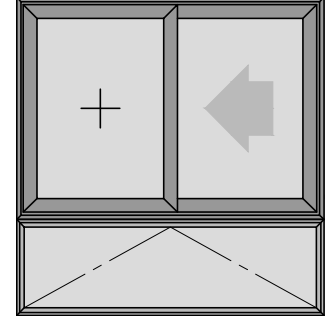

28

dış görünüş-external view

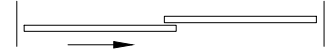

TIP - 29 :
çift raylı kasa,dört kanat kayar,üste sabit pencere
double tracks,four sashes slide,fix window above

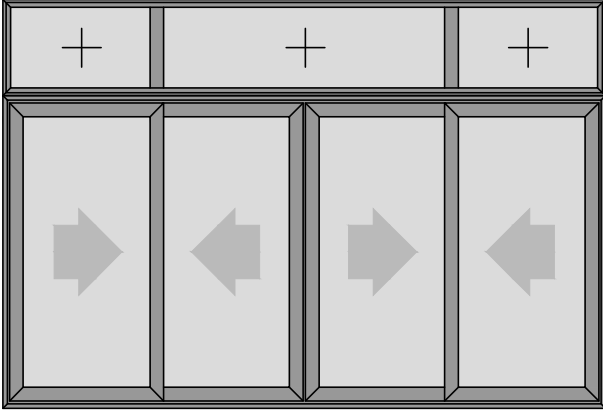

29

dış görünüş-external view



TIP - 30 :
çift raylı kasa,çift kanat kayar,çift kanat sabit,üste sabit pencere
double tracks,two sashes slide,two sashes fix,fix window above

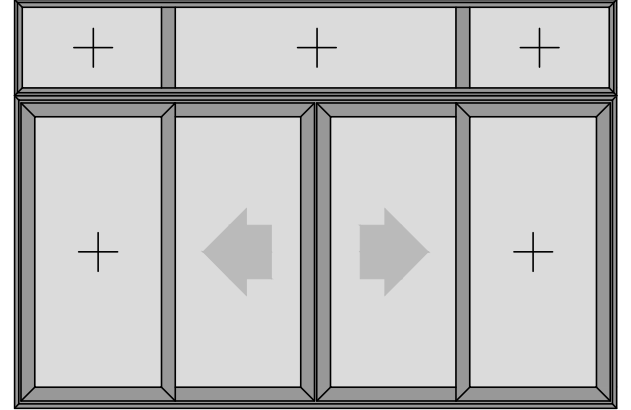

30

dış görünüş-external view



TIP - 31 :
çift raylı kasa,ortada tek kanat sabit,çift kanat kayar,altta sabit pencere
double tracks,one sash fix in the middle,two sashes slide,fix window bottom

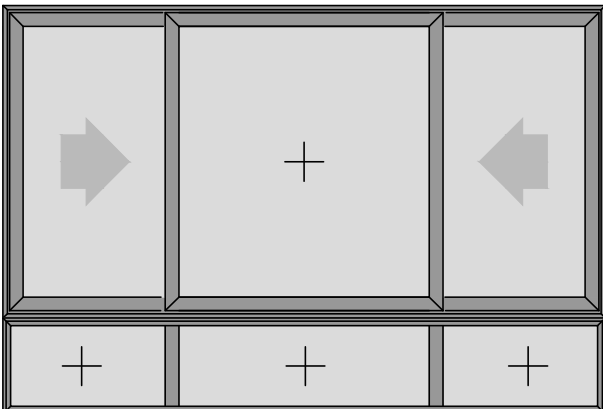

31

dış görünüş-external view



TIP - 32 :
çift raylı kasa,ortada tek kanat sabit,çift kanat kayar,üste sabit pencere
double tracks,one sash fix in the middle,two sashes slide,fix window above

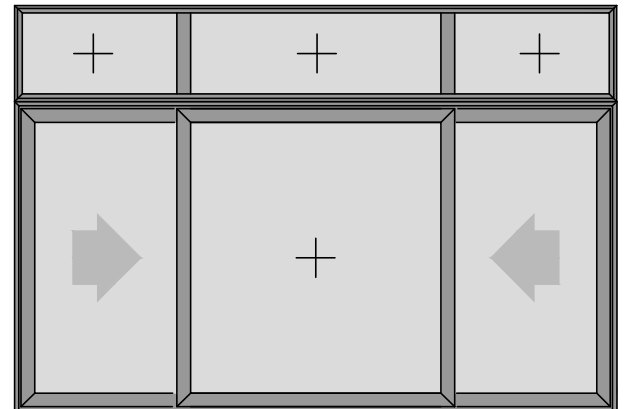

32

dış görünüş-external view



TIP - 33 :
çift raylı kasa,dört kanat kayar,üstte vasistas pencere
double tracks,four sashes slide,bottom hung window above

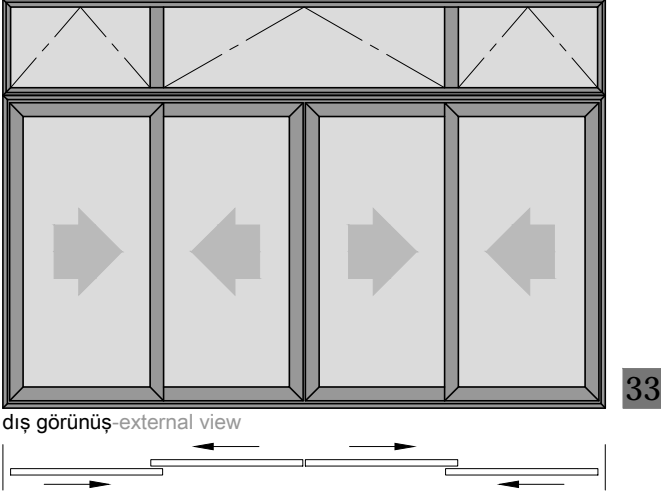

TIP - 34 :
çift raylı kasa,ortada tek kanat kayar,çift kanat sabit,
double tracks,one sash slide in the middle,two sashes fix

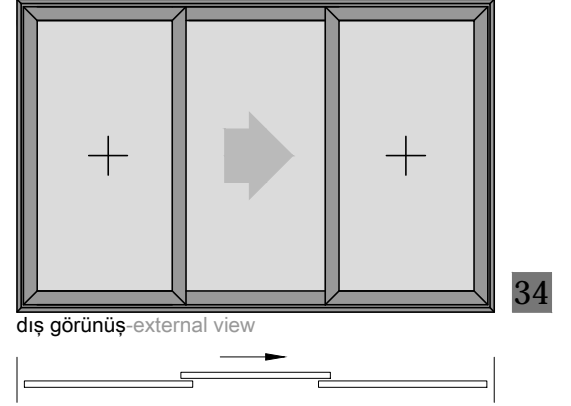

TIP - 35 :
çift raylı kasa,ortada tek kanat sabit,çift kanat kayar,altta vasistas pencere,
double tracks,one sash fix in the middle,two sashes slide,
bottom hung window bottom

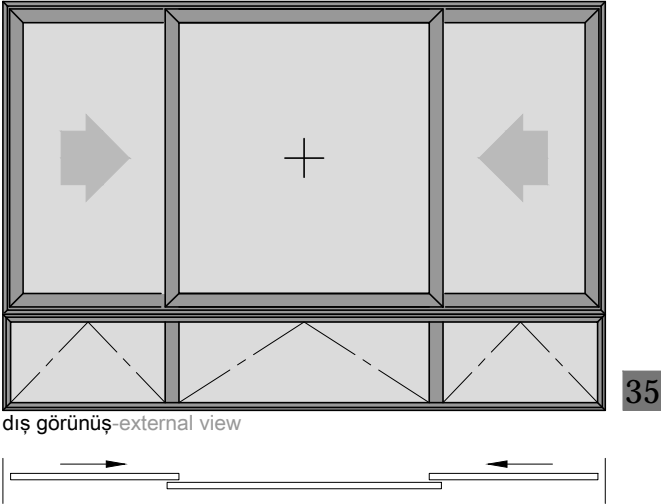

TIP - 36 :
çift raylı kasa,ortada tek kanat sabit,çift kanat kayar,üstte vasistas pencere,
double tracks,one sash fix in the middle,two sashes slide,
bottom hung window top

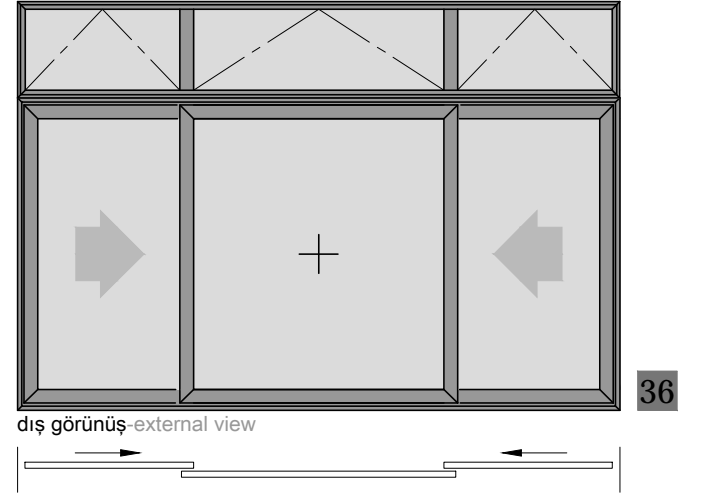

TIP - 37 :
çift raylı kasa,ortada tek kanat kayar,çift kanat sabit,
altta sabit cam ve vasistas pencere
double tracks,one sash slide in the middle,two sashes fix,
single bottom hung window,double fix window bottom

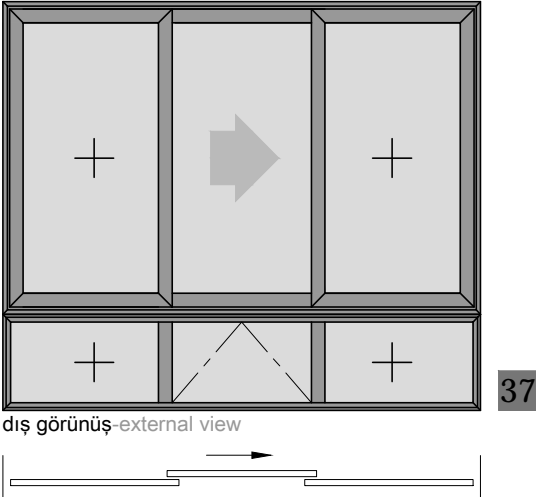

TIP - 38 :
çift raylı kasa,ortada tek kanat kayar,çift kanat sabit,
üstte sabit cam ve vasistas pencere
double tracks,one sash slide in the middle,two sashes fix,
single bottom hung window,double fix window top

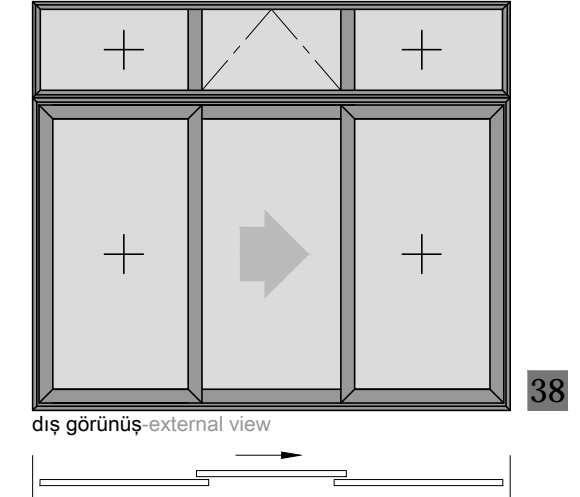

TİP - 39 :

sineklikli çift raylı kasa,çift kanat kayar,
tek sineklik kanat

double tracks with fly screen rail,
double sash slide,single sash fly screen

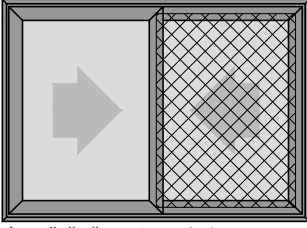

39

dış görünüş-external view



TİP - 40 :

sineklikli çift raylı kasa,tek kanat kayar,
tek kanat sabit,tek sineklik kanat

double tracks with fly screen rail,single sash slide,
single sash fix,single sash fly screen

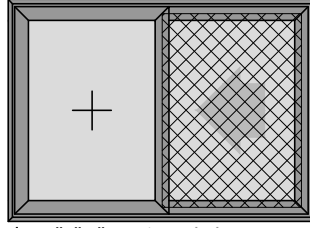

40

dış görünüş-external view

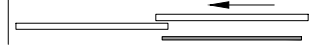

TİP - 41 :

sineklikli çift raylı kasa,dört kanat kayar,çift sineklik kanat

double tracks with fly screen rail,four sashes slide,double sash
fly screen

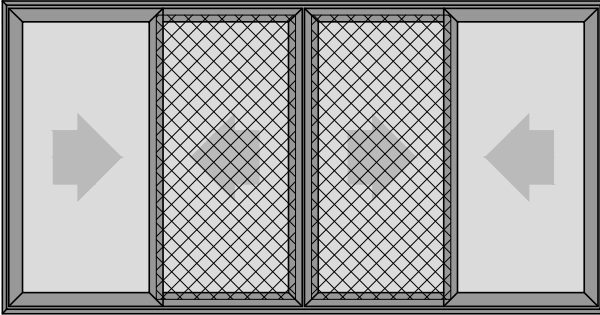

41

dış görünüş-external view



TİP - 42 :

sineklikli çift raylı kasa,iki kanat kayar,iki kanat sabit,çift sineklik kanat

double tracks with fly screen rail,double sashes slide,double sash fix,
double sash fly screen

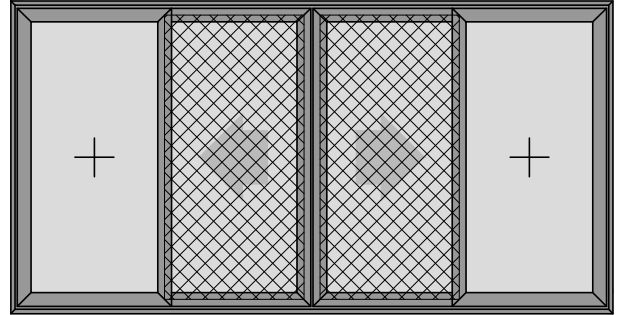

42

dış görünüş-external view



TİP - 43 :

sineklikli çift raylı kasa,iki kanat kayar,ortada tek kanat sabit,
çift sineklik kanat

double tracks with fly screen rail,double sashes slide,middle single sash fix
double sash fly screen

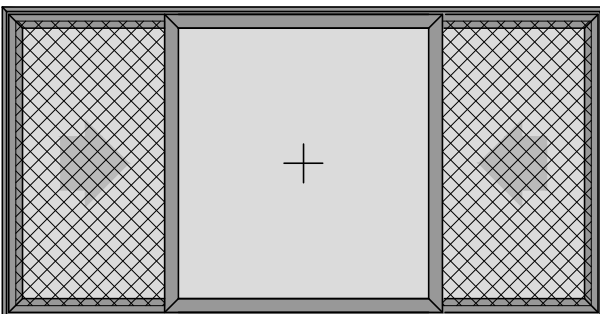

43

dış görünüş-external view



TİP - 44 :

sineklikli çift raylı kasa,tek kanat kayar,
çift kanat sabit,tek sineklik kanat

double tracks with fly screen rail,single sash slide,
double sash fix,single sash fly screen

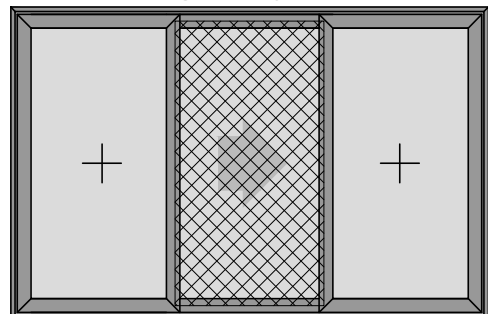

44

dış görünüş-external view

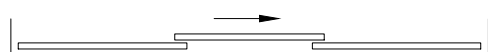

TİP - 45 :
üç raylı kasa,altı kanat kayar,
triple tracks,six sashes slide,

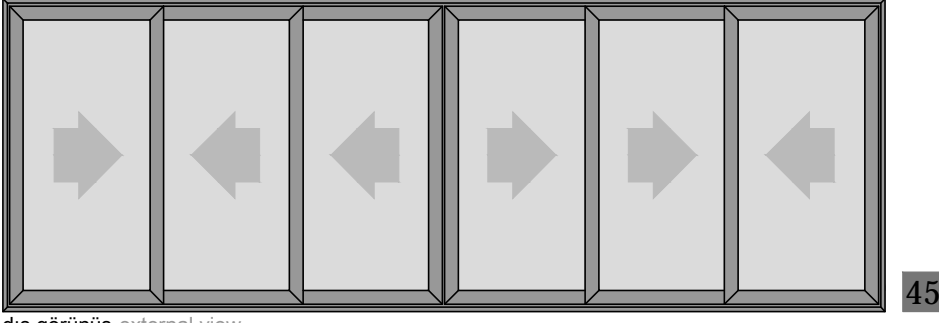

dış görünüş-external view

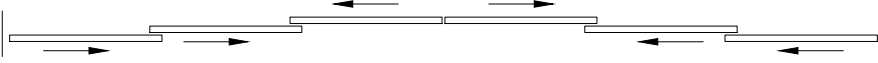

TİP - 46 :
üç raylı kasa,üç kanat kayar,çift kanat sabit,
triple tracks,three sashes slide,two sashes fix

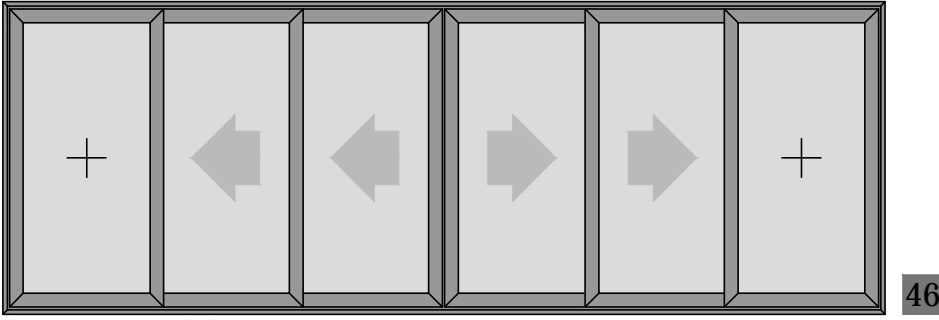

dış görünüş-external view



TİP - 47 :
üç raylı kasa,iki kanat kayar,tek kanat sabit,
triple tracks,two sashes slide,one sash fix

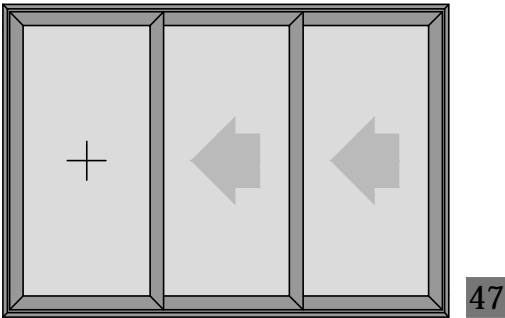

dış görünüş-external view

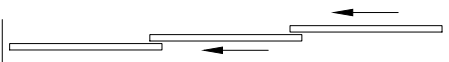

TİP - 48 :
üç raylı kasa,üç kanat kayar,
triple tracks,three sashes slide,

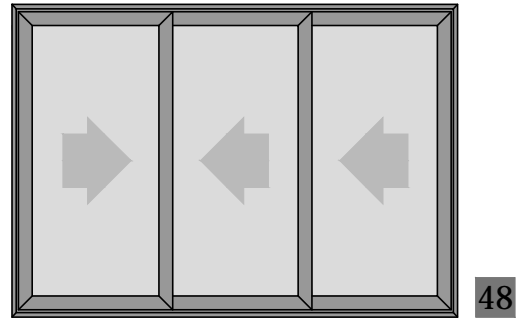

dış görünüş-external view

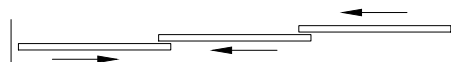



NOVA
BASİT SÜRME KAPI ve PENCERE SİSTEMİ
SIMPLE SLIDE DOOR and WINDOW SYSTEM

TAM ÖLÇEKLİ ALUMİNYUM PROFİLLER
FULL SCALE ALUMINIUM PROFILES

P 1254

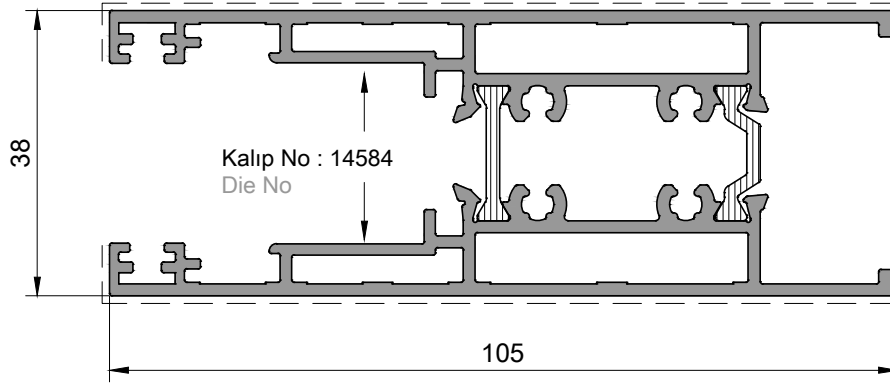
Yatay Kanat Profili / 2,255kg/mt
Horizontal Sash Profile





I_x  17.77 cm⁴ I_y  61.80 cm⁴

P 1255

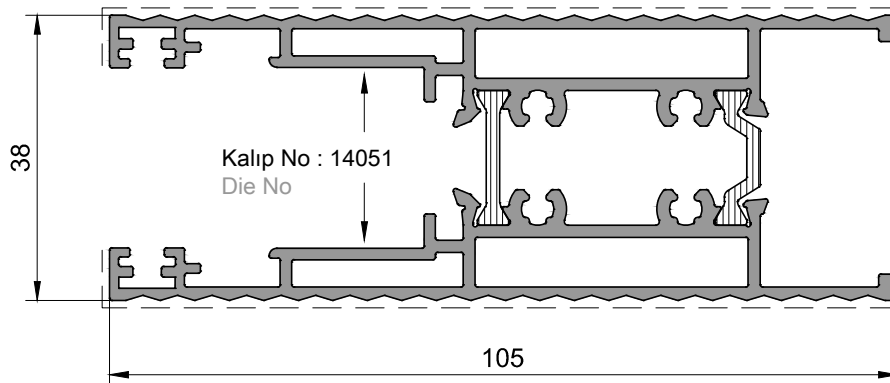
Yatay Kanat Profili / 2,135kg/mt
Horizontal Sash Profile



I_x  15.28 cm⁴ I_y  55.76 cm⁴

P 1256

Kanat Profili / 1,950kg/mt
Sash Profile

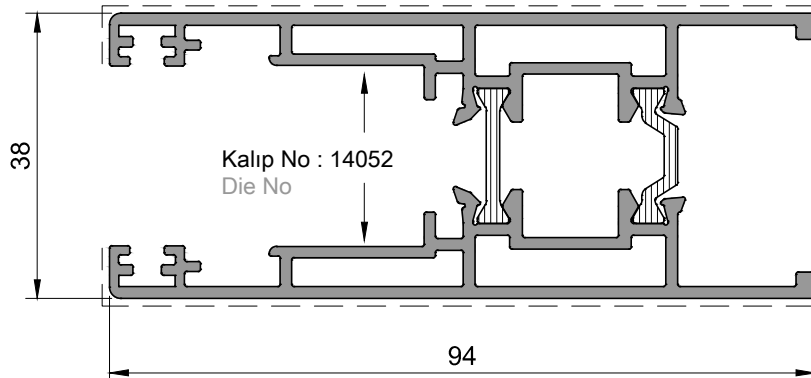

I_x  15.26 cm⁴ I_y  41.32 cm⁴

P 1630

Düsey Kanat Profili / 1,280kg/mt
Vertical Sash Profile

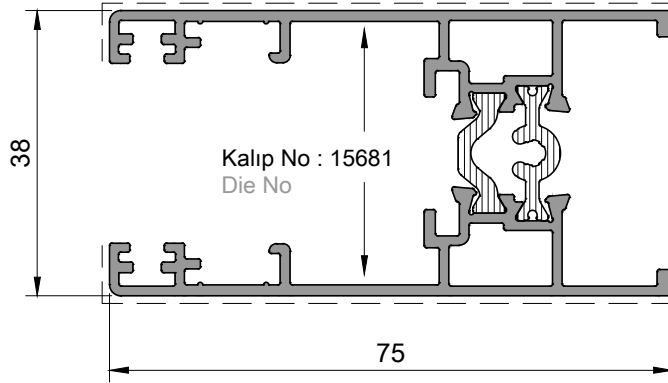

I_x)
9.72 cm⁴

) I_y
18.74 cm⁴

P 1631

Yatay Kanat Profili / 1,545kg/mt
Horizontal Sash Profile

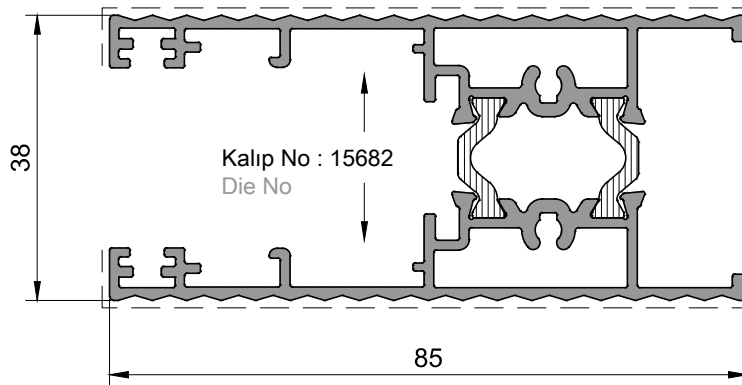

I_x)
11.07 cm⁴

) I_y
27.97 cm⁴

P 1633

Dar Kenet Profili / 0,900kg/mt
Slim Interlock Profile

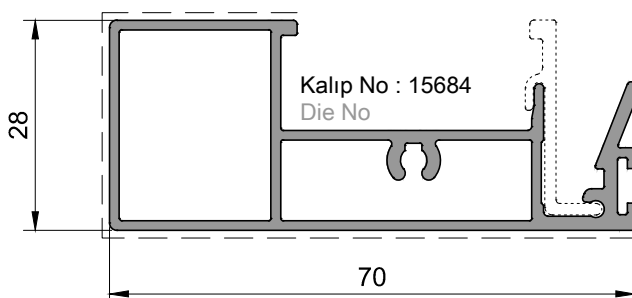

I_x)
17.36 cm⁴

) I_y
2.23 cm⁴

P 1257

Düsey Kanat Profili / 1,980kg/mt
Vertical Sash Profile

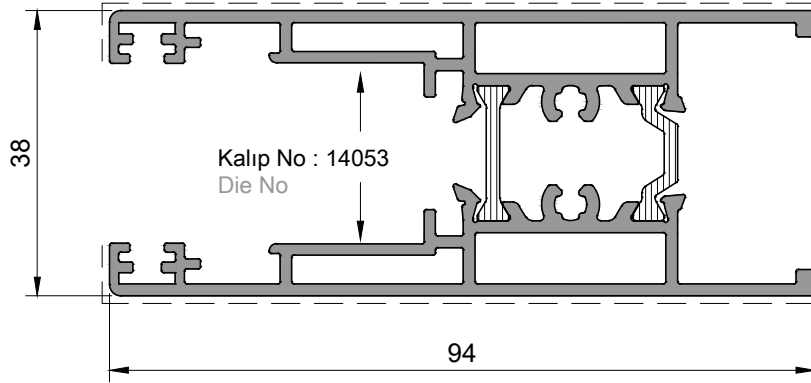

I_x) 15.11 cm⁴ I_y) 41.44 cm⁴

P 1258

Dar Kenet Profili / 0,895kg/mt
Slim Interlock Profile

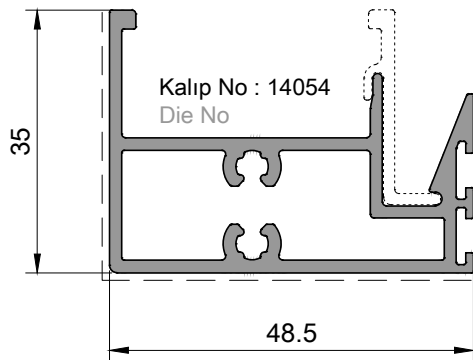

I_x) 8.97 cm⁴ I_y) 2.41 cm⁴

P 1259

Dar Kenet Profili / 1,605kg/mt
Slim Interlock Profile

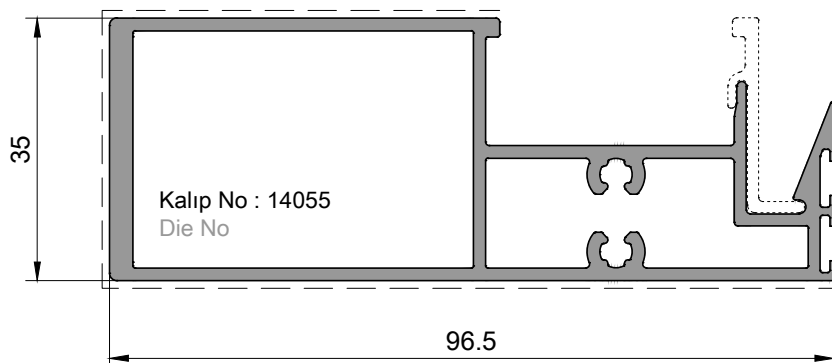

I_x) 62.19 cm⁴ I_y) 7.82 cm⁴

P 1632

Dar Kenet Profili / 0,660kg/mt
Slim Interlock Profile

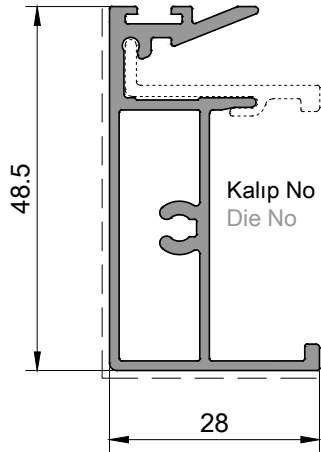

I_x)
6.78 cm⁴

I_y)
1.08 cm⁴

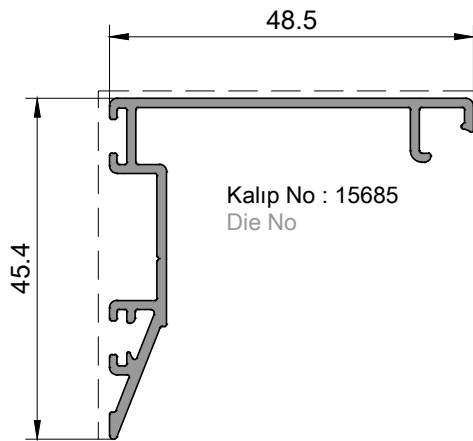

P 1634

Kenet Kapak Profil / 0,435kg/mt
Interlock Cap Profile

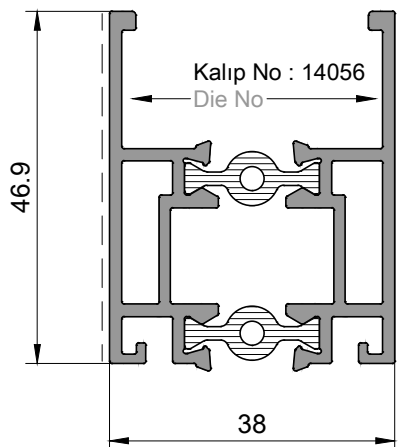

P 1260

Dar Kenet Profili / 1,185kg/mt
Slim Interlock Profile

I_x)
7.80 cm⁴

I_y)
6.28 cm⁴

P 1261

Dar Kenet Profili / 1,895kg/mt
Slim Interlock Profile

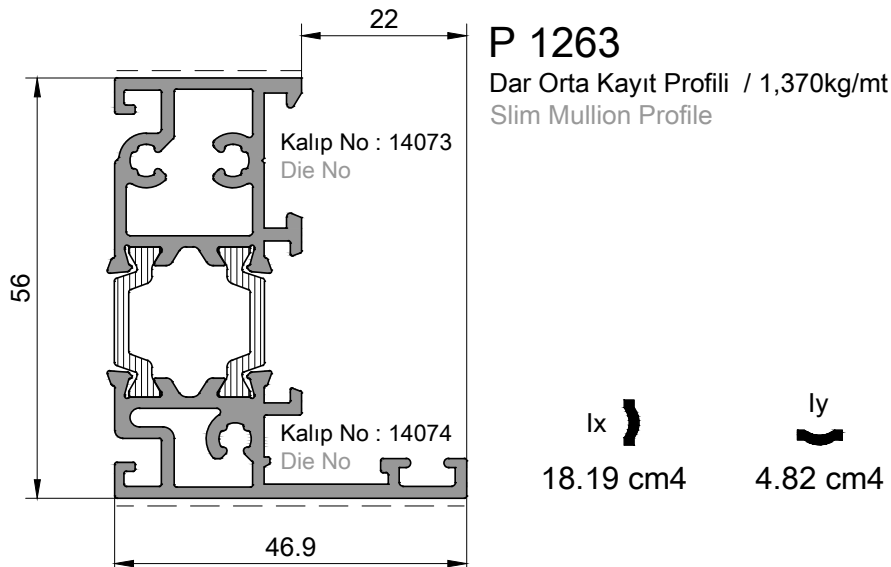
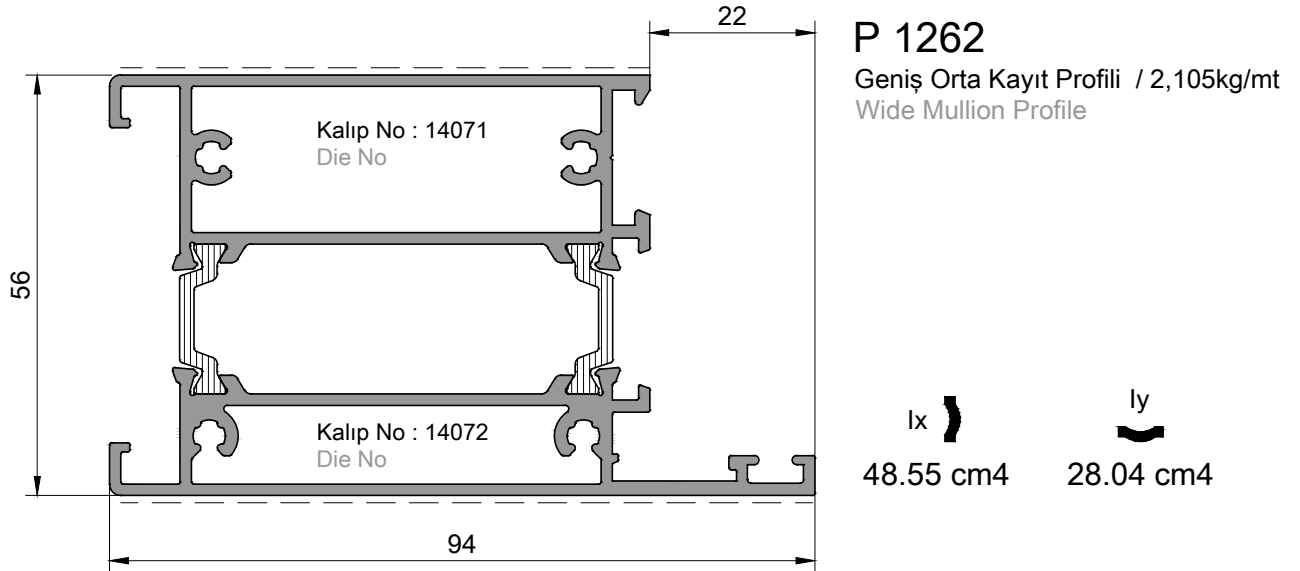
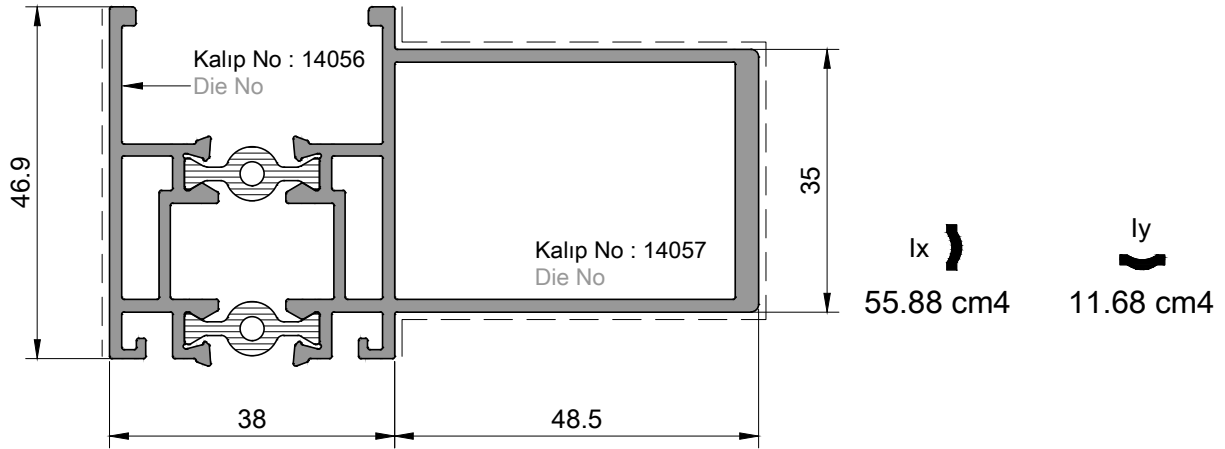

P 1263

Dar Orta Kayıt Profili / 1,370kg/mt
Slim Mullion Profile

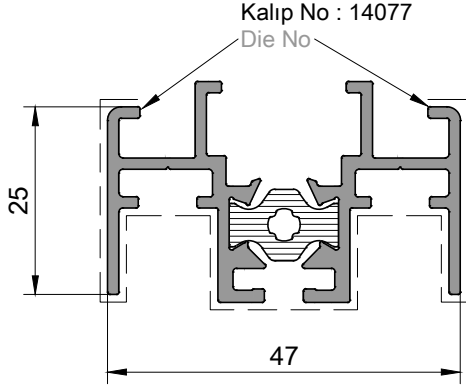

P 1264

Çift Kanat Adaptör Profili / 0,900kg/mt
Double Sash Adapter Profile

lx) 6.60 cm⁴ ly) 1.79 cm⁴

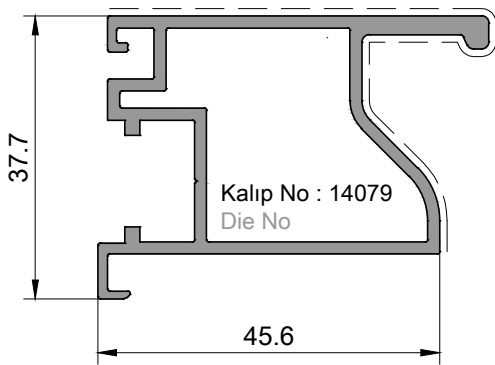

P 1265

Çift Kanat Adaptör Profili / 0,880kg/mt
Double Sash Adapter Profile

lx) 8.39 cm⁴ ly) 4.77 cm⁴

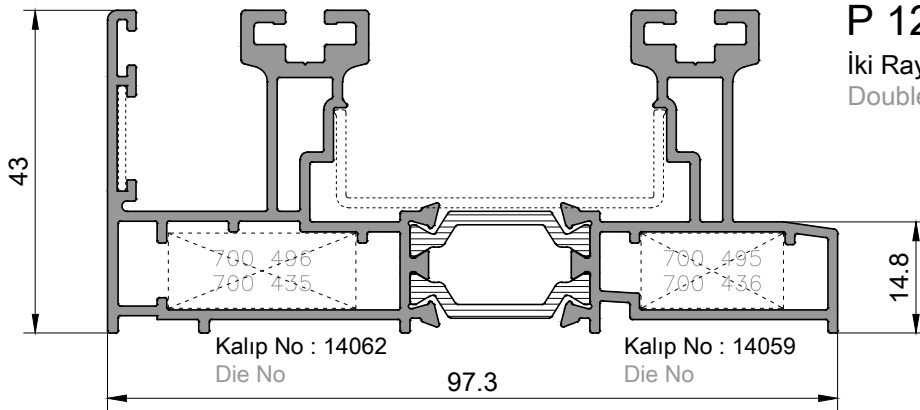

P 1267

İki Raylı Kasa Profil / 1,910kg/mt
Double Track Rail Profile

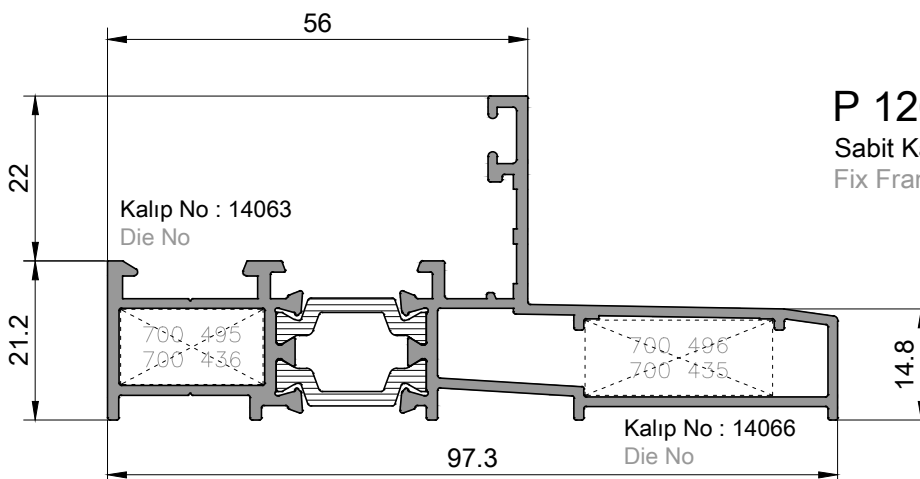

P 1268

Sabit Kasa Profil / 1,315kg/mt
Fix Frame Profile

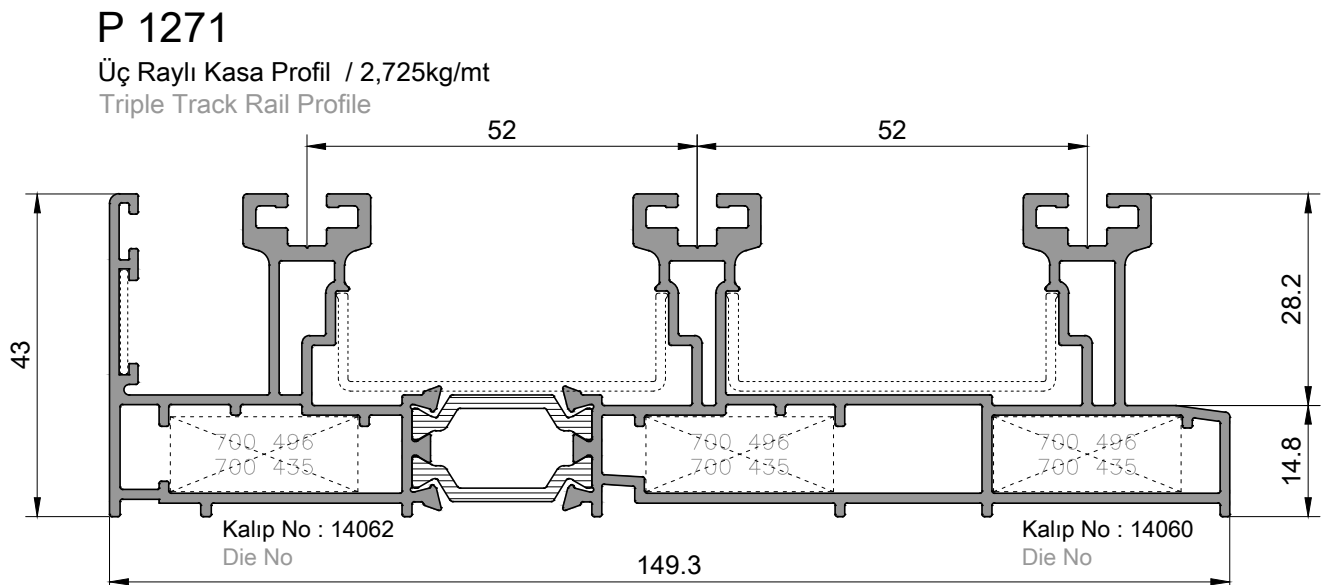
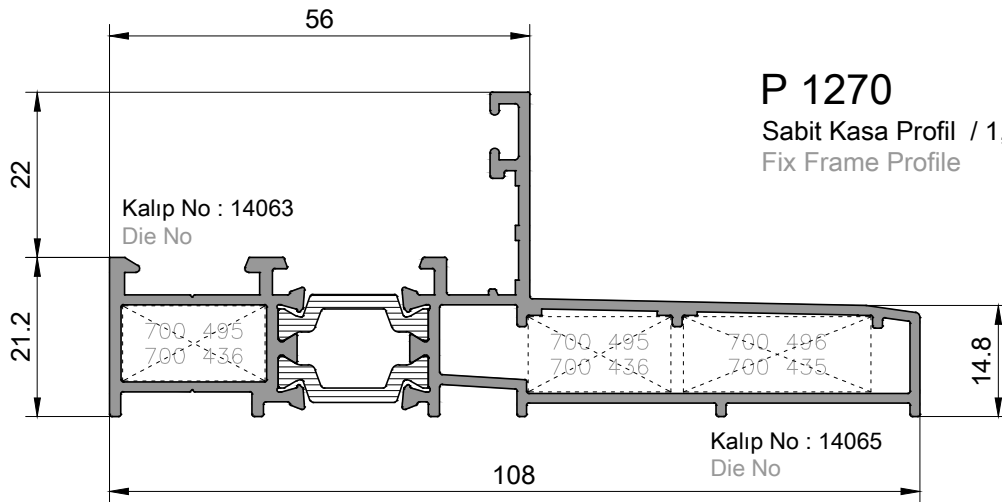
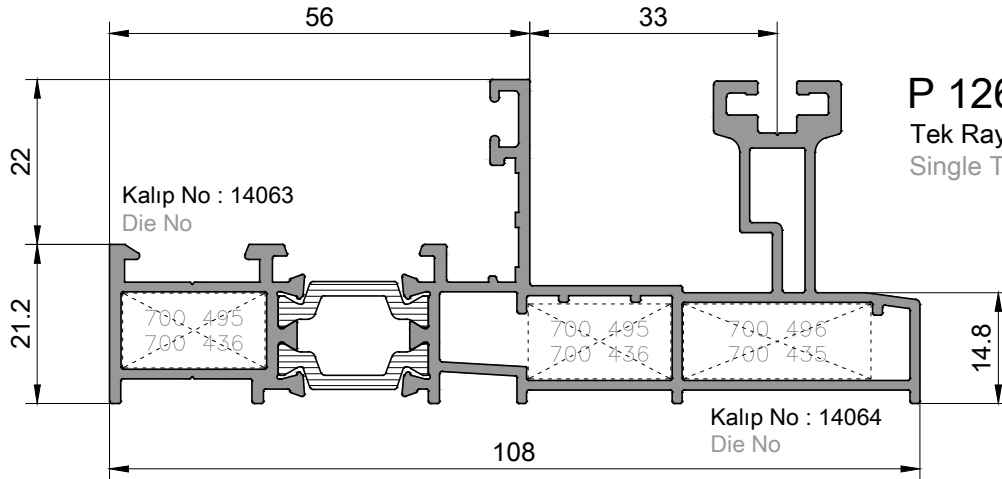

P 1272

Sineklikli Kasa Profil / 2,455kg/mt
Fly Screen Rail Profile

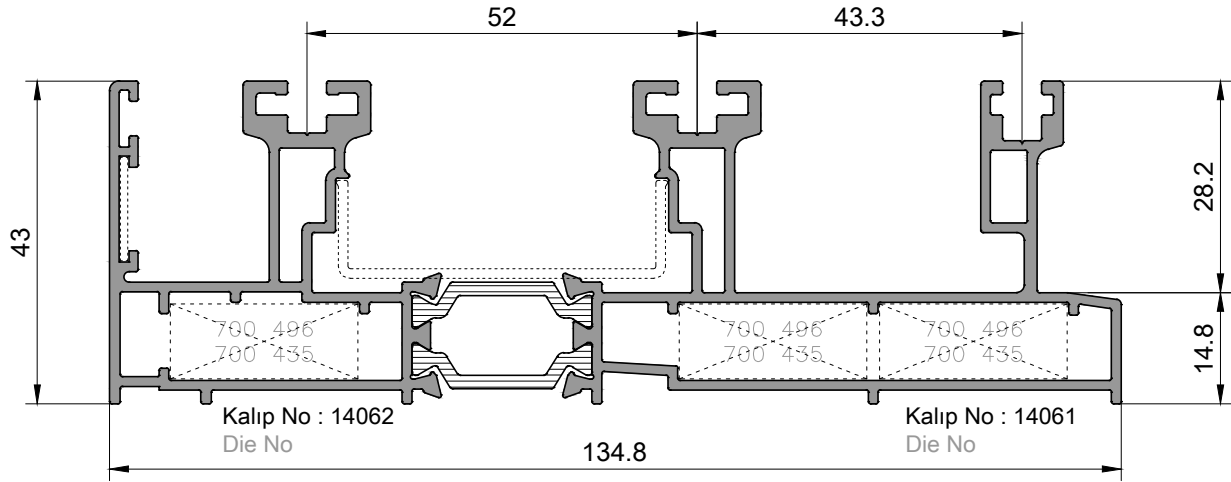

P 1273

Kasa Kapatma Profil / 0,445kg/mt
Frame Closing Profile

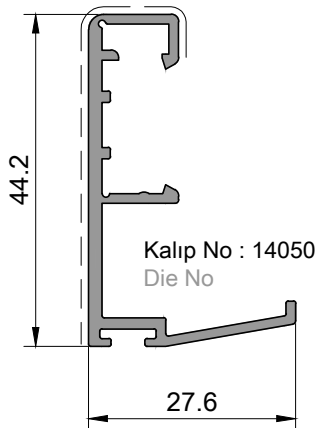

P 1274

Kasa Kapatma Profil / 0,515kg/mt
Frame Closing Profile

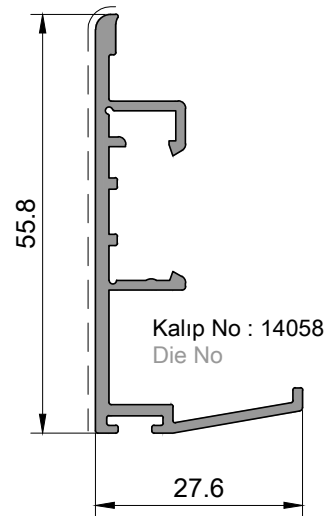

P 1275

Kasa Kapatma Profil / 0,880kg/mt
Frame Closing Profile

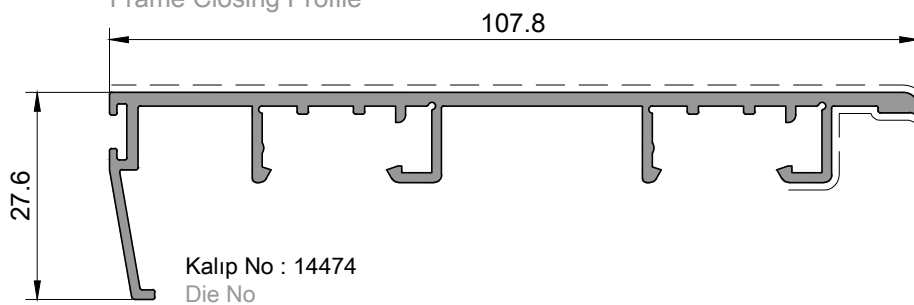

P 1276

Kasa Kapatma Profil / 0,810kg/mt
Frame Closing Profile

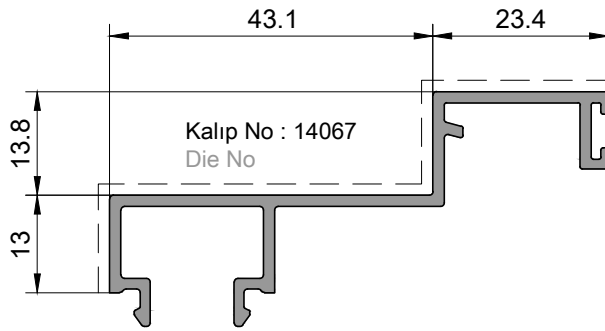
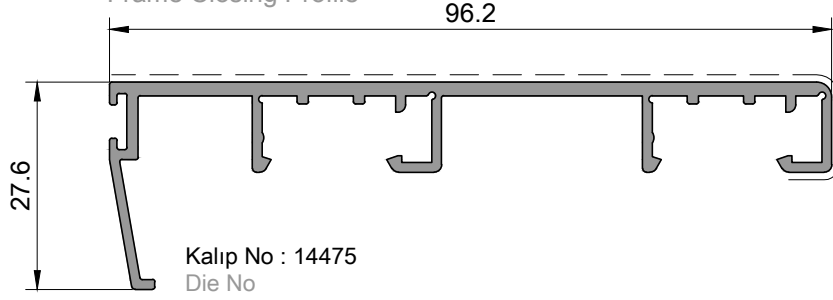

P 1277

Kasa Kapatma Profil / 0,555kg/mt
Frame Closing Profile

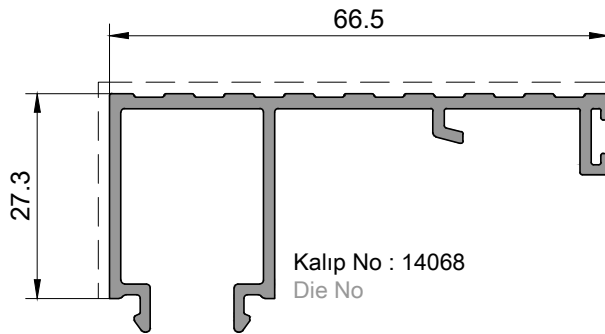

P 1278

Eşik Profil / 0,675kg/mt
Threshold Profile

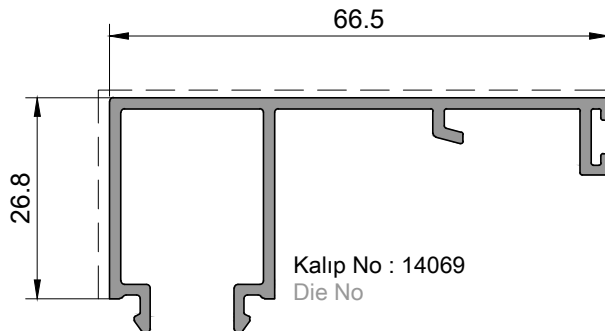

P 1279

Kasa Kapatma Profil / 0,625kg/mt
Frame Closing Profile

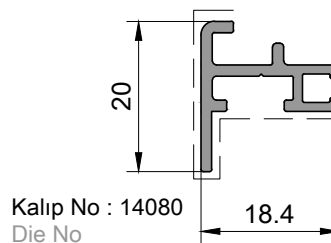

P 1266

Çift Kanat Adaptör Profili / 0,215kg/mt
Double Sash Adapter Profile

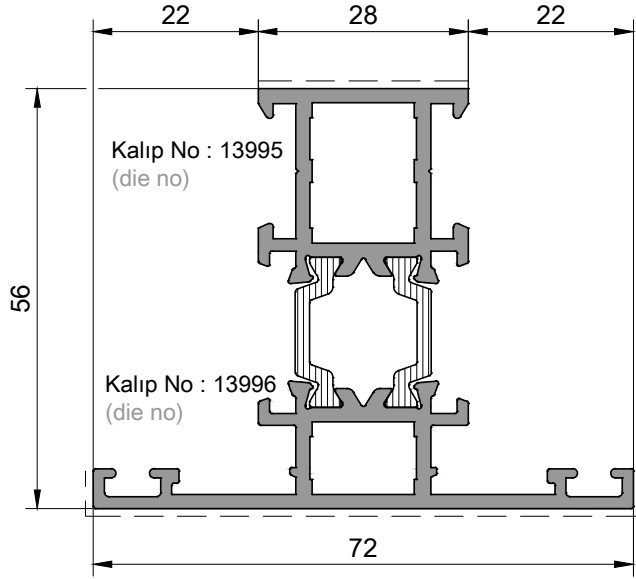

P 1244

Orta Kayıt Profili / 1,530kg/mt
Mullion Profile

I_x 17.31 cm⁴ I_y 10.65 cm⁴

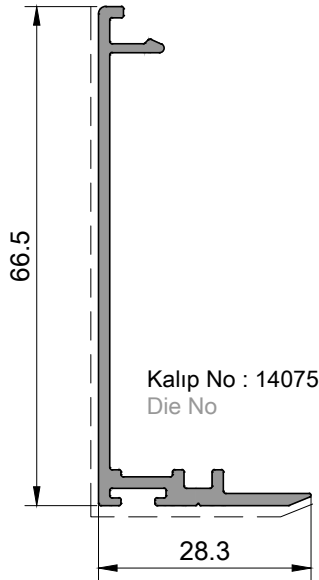

P 1281

Kenet Kapak Profili / 0,465kg/mt
Interlock Cap Profile

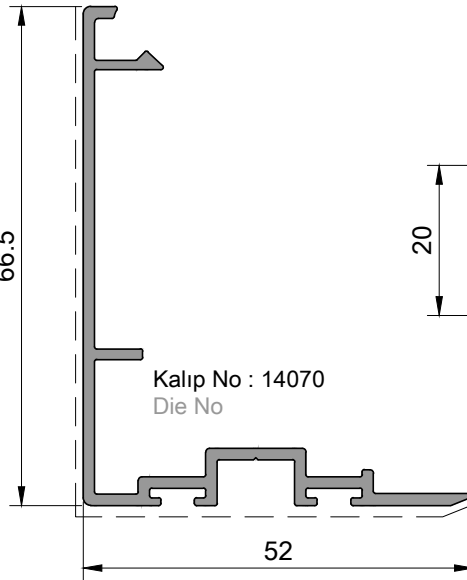

P 1280

Kenet Kapak Profili / 0,635kg/mt
Interlock Cap Profile

P 1321

Pervaz Profili / 0,160kg/mt
Architrave Profile

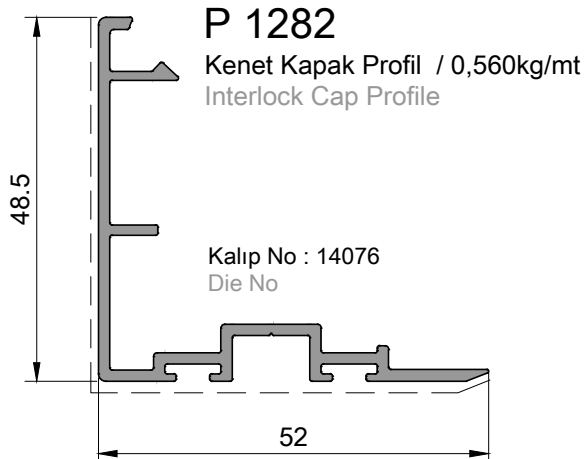
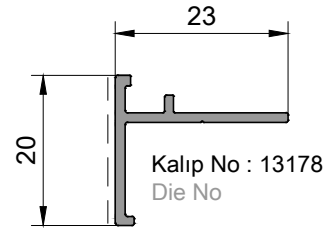

P 1282

Kenet Kapak Profili / 0,560kg/mt
Interlock Cap Profile

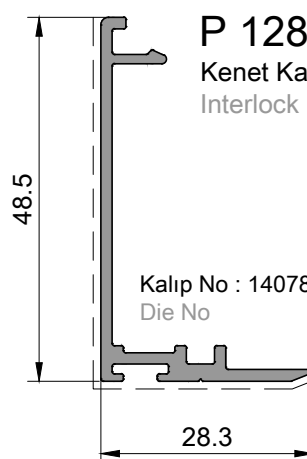

P 1283

Kenet Kapak Profili / 0,390kg/mt
Interlock Cap Profile

P 1173

Kanat Profili / 1,535kg/mt
Sash Profile

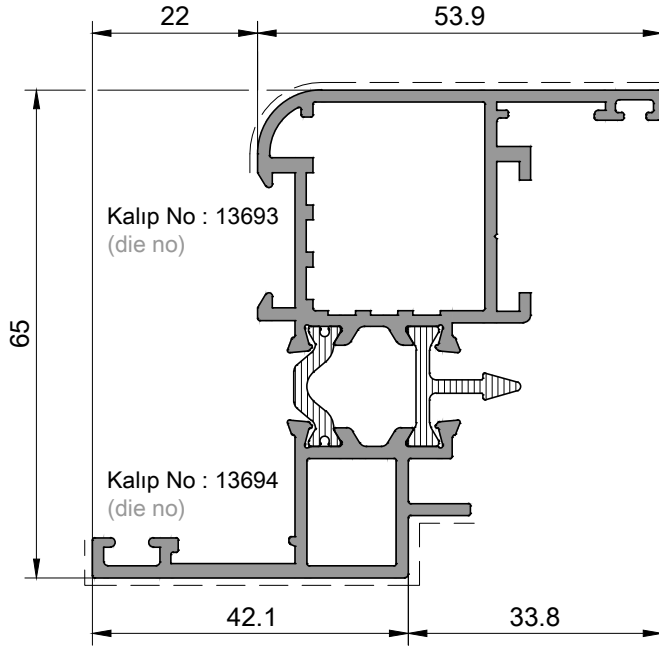

lx)
27.42 cm⁴

ly)
7.64 cm⁴

P 1242

Kanat Profili / 1,715kg/mt
Sash Profile

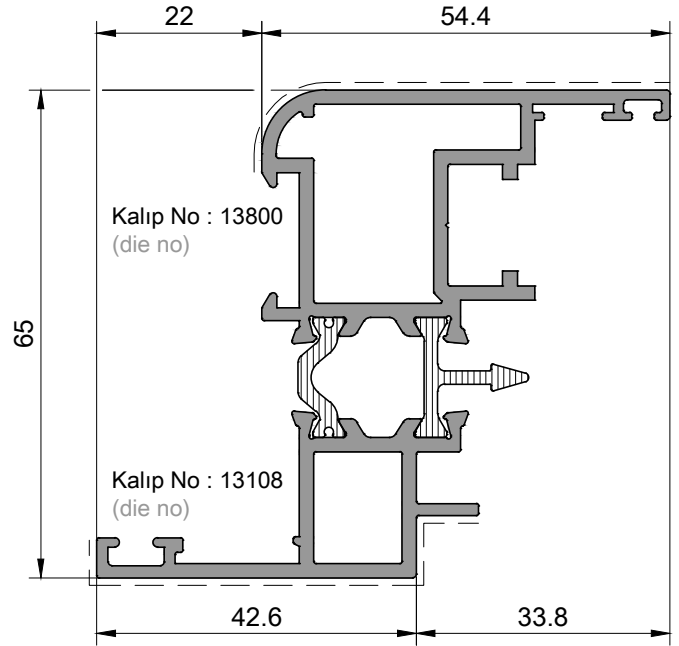

lx)
30.22 cm⁴

ly)
8.03 cm⁴

P 1327

Adaptör Profili / 2,505kg/mt
Adepter Profile

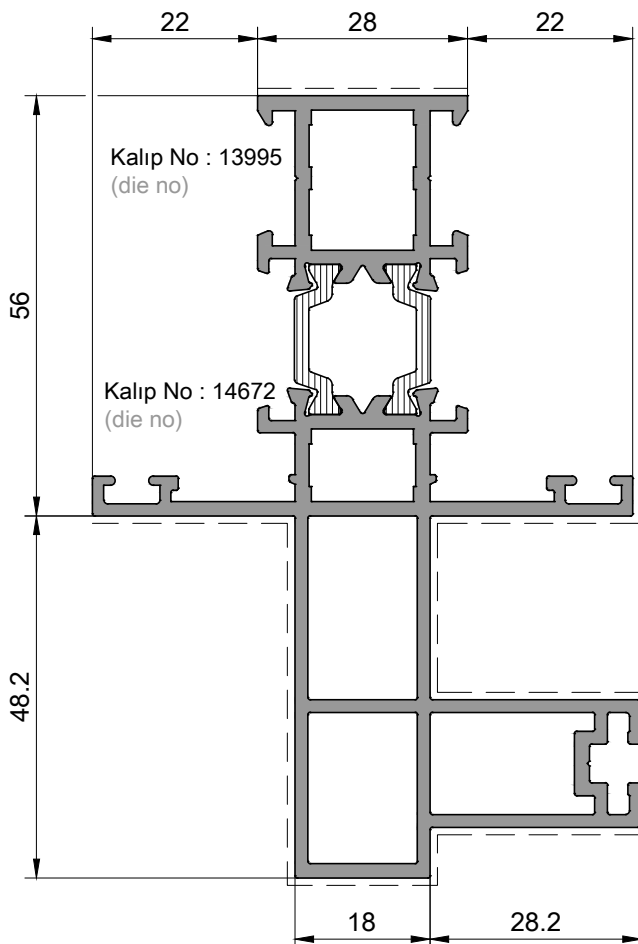

lx)
84.63 cm⁴

ly)
18.44 cm⁴

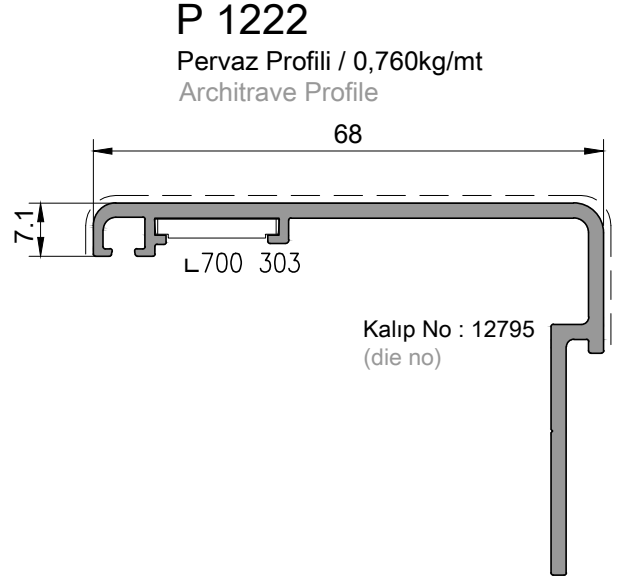
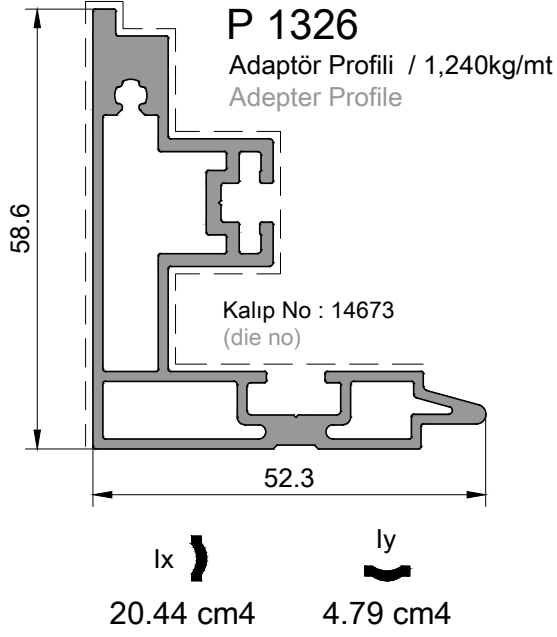

P 1284
Sineklik Adaptör Profili / 0,730kg/mt
Fly Screen Adepter Profile

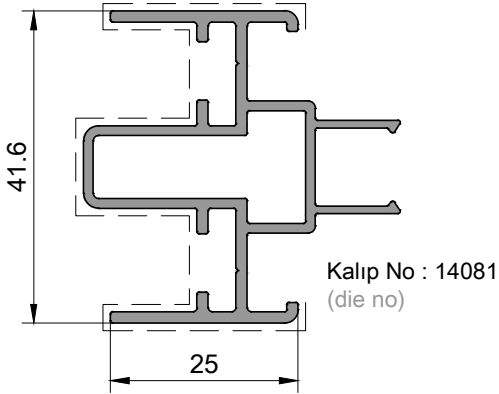

P 1285
Yatay Sineklik Profili / 0,980kg/mt
Horizontal Fly Screen Profile

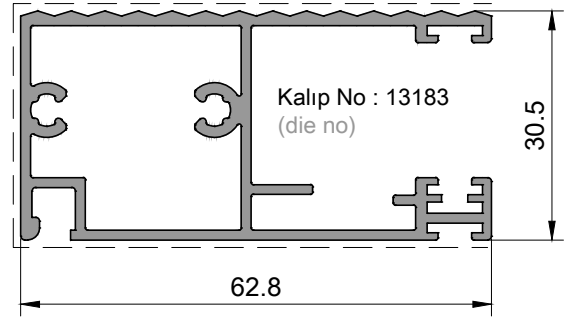

P 1286
Düsey Sineklik Profili / 0,725kg/mt
Vertical Fly Screen Profile

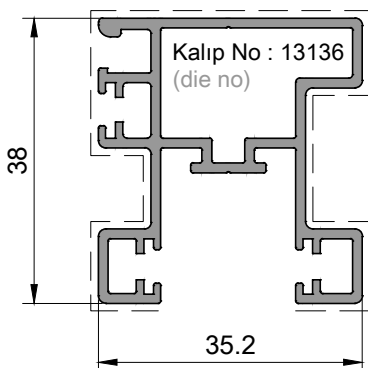

P 1347
Yatay Sineklik Profili / 0,920kg/mt
Horizontal Fly Screen Profile

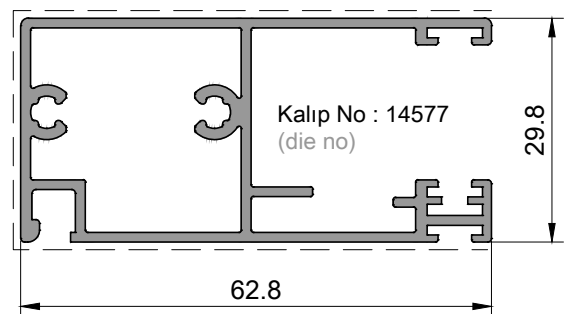

P 1494

Çıta Profili / 0,325kg/mt
Glazing Bead Profile

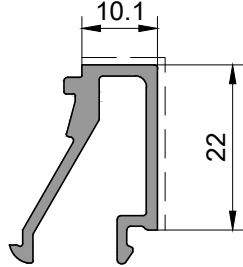

Kalıp : 15306
(die no)

P 1495

Çıta Profili / 0,270kg/mt
Glazing Bead Profile

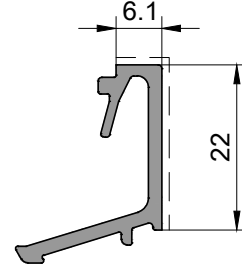

Kalıp : 15307
(die no)

P 1496

Çıta Profili / 0,245kg/mt
Glazing Bead Profile

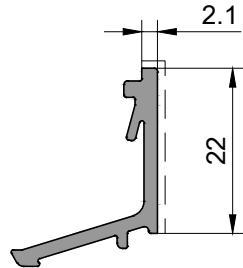

Kalıp : 15308
(die no)

P 1497

Çıta Profili / 0,435kg/mt
Glazing Bead Profile

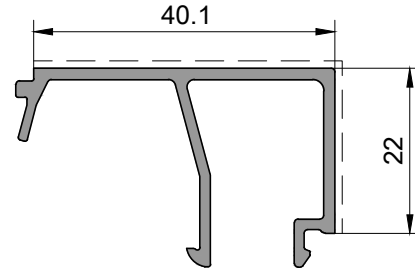

Kalıp : 15309
(die no)

P 1177

Pervaz Profili / 0,300kg/mt
Architrave Profile

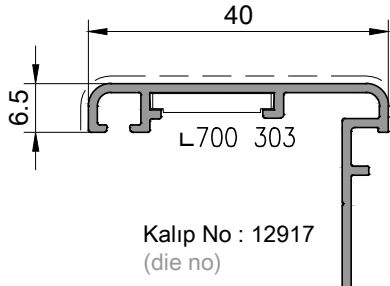

Kalıp No : 12917
(die no)

P 1178

Pervaz Profili / 0,375kg/mt
Architrave Profile

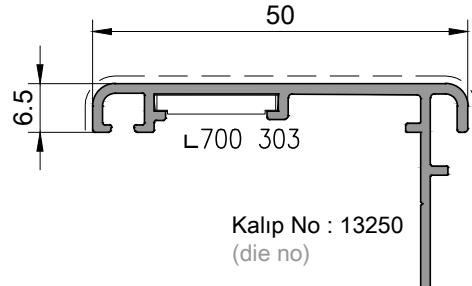

Kalıp No : 13250
(die no)

P 1176

Çıta Profili / 0,335kg/mt
Glazing Bead Profile

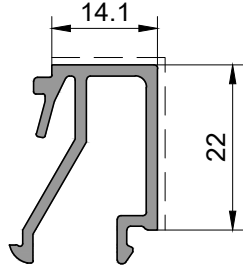

Kalıp No : 13698
(die no)

P 1179

Çıta Profili / 0,350kg/mt
Glazing Bead Profile

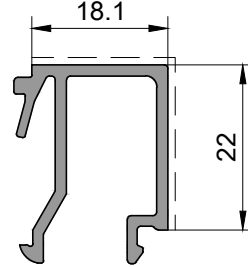

Kalıp No : 13671
(die no)

P 1180

Çıta Profili / 0,380kg/mt
Glazing Bead Profile

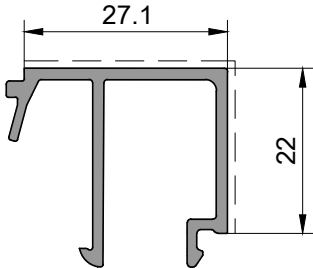

Kalıp No : 13670
(die no)

P 1105

Çıta Profili / 0,360kg/mt
Glazing Bead Profile

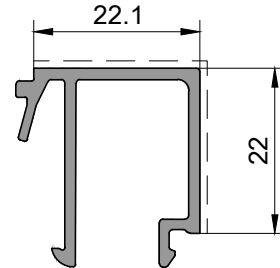

Kalıp No : 13113
(die no)

P 1158

Çıta Profili / 0,365kg/mt
Glazing Bead Profile

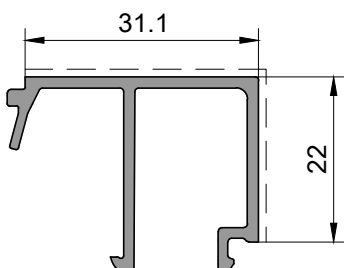

Kalıp No : 13111
(die no)

P 1498

Çıta Profili / 0,415kg/mt
Glazing Bead Profile

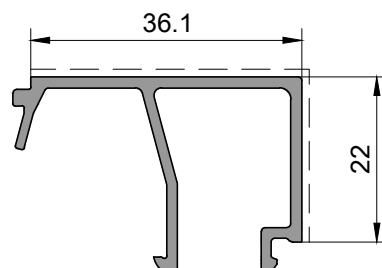

Kalıp : 15310
(die no)

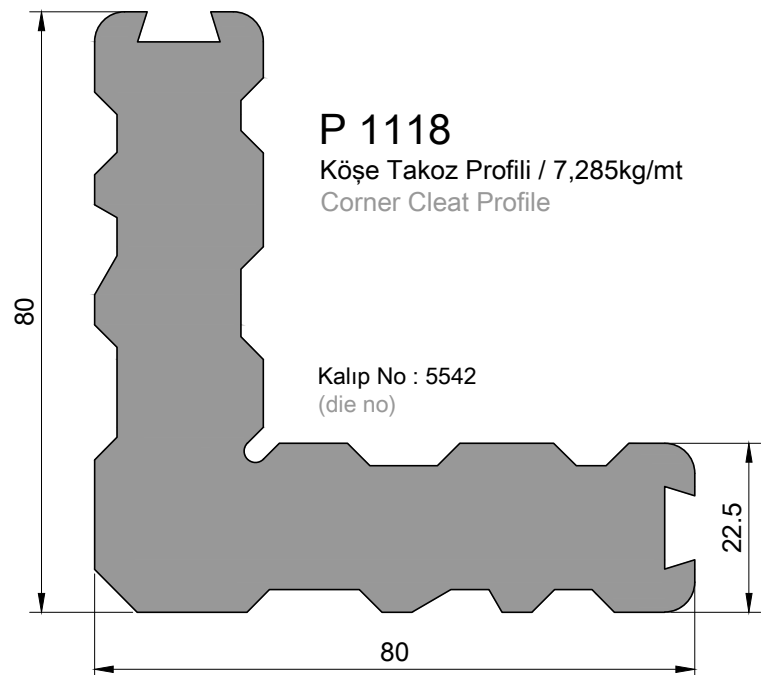
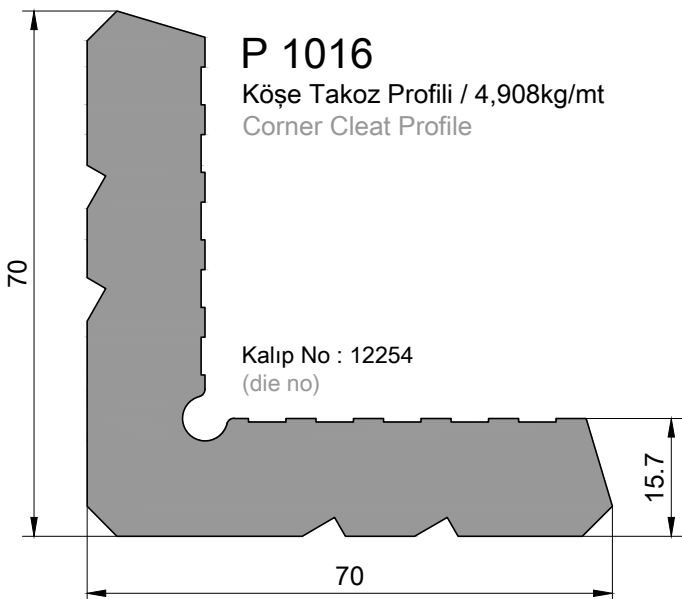
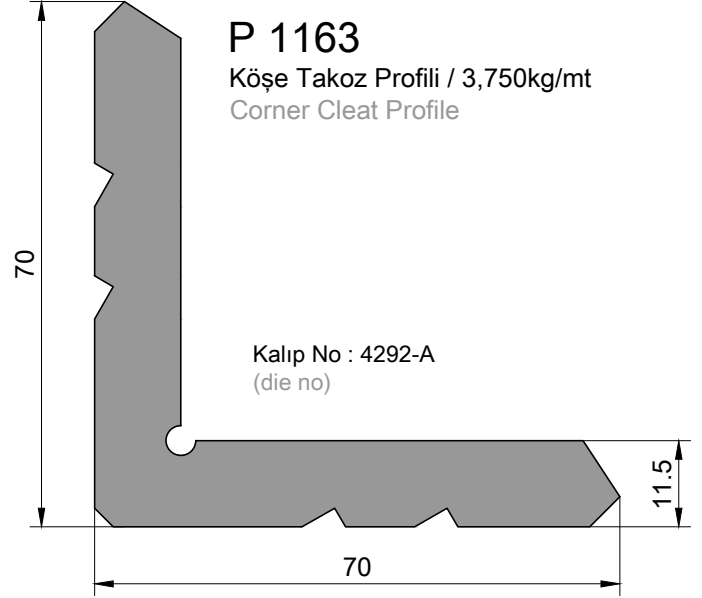
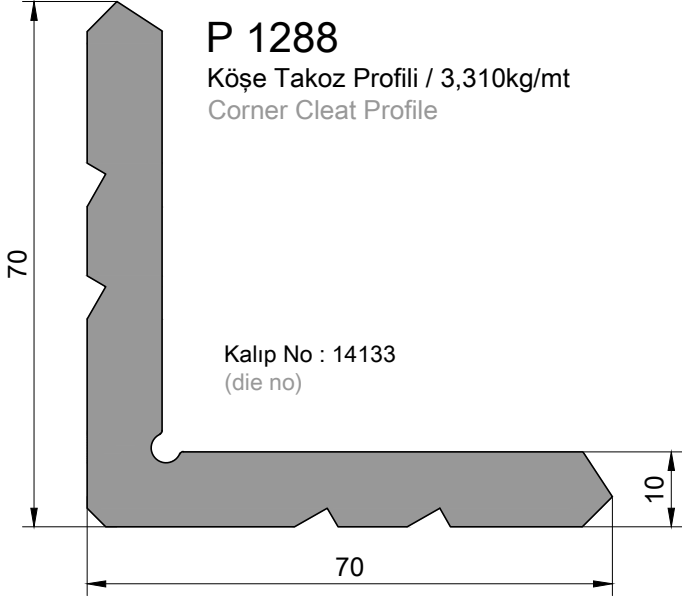

NOVA
BASİT SÜRME KAPI ve PENCERE SİSTEMİ
SIMPLE SLIDE DOOR and WINDOW SYSTEM

TEK RAYLI KASA SİSTEM DETAYLARI
SINGLE TRACK RAIL PRINCIPAL SECTION

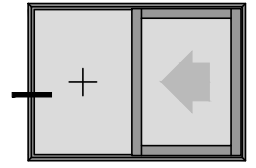

dış görünüş - external view

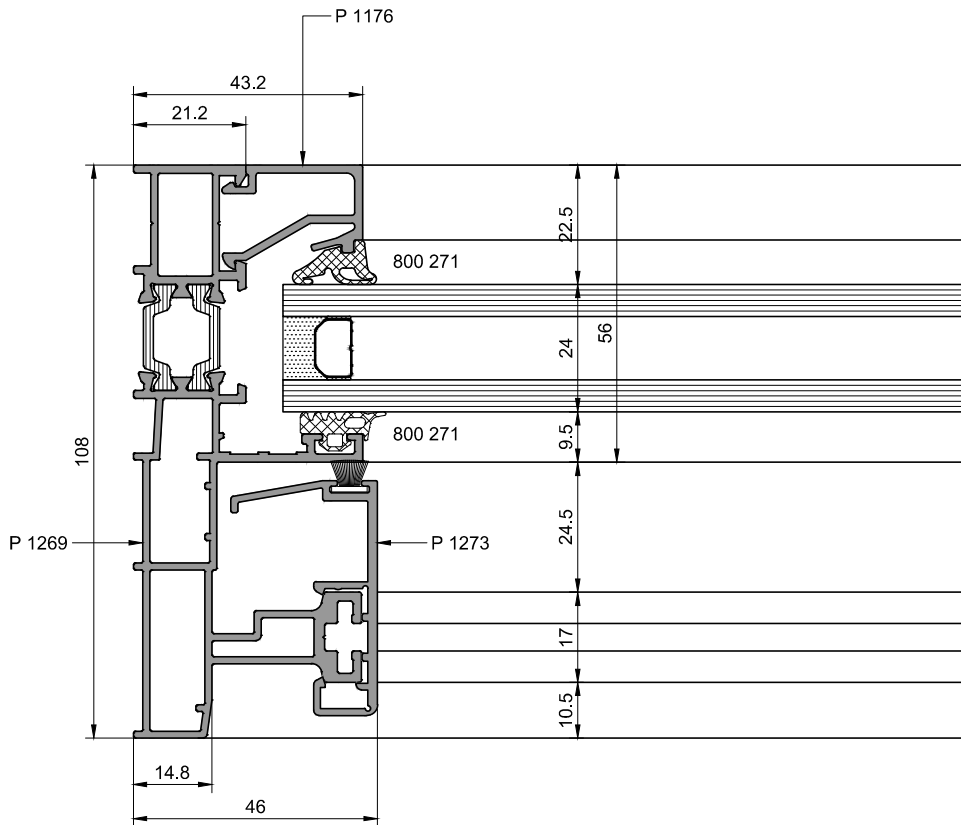

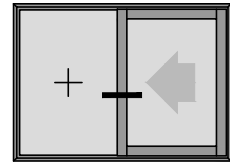
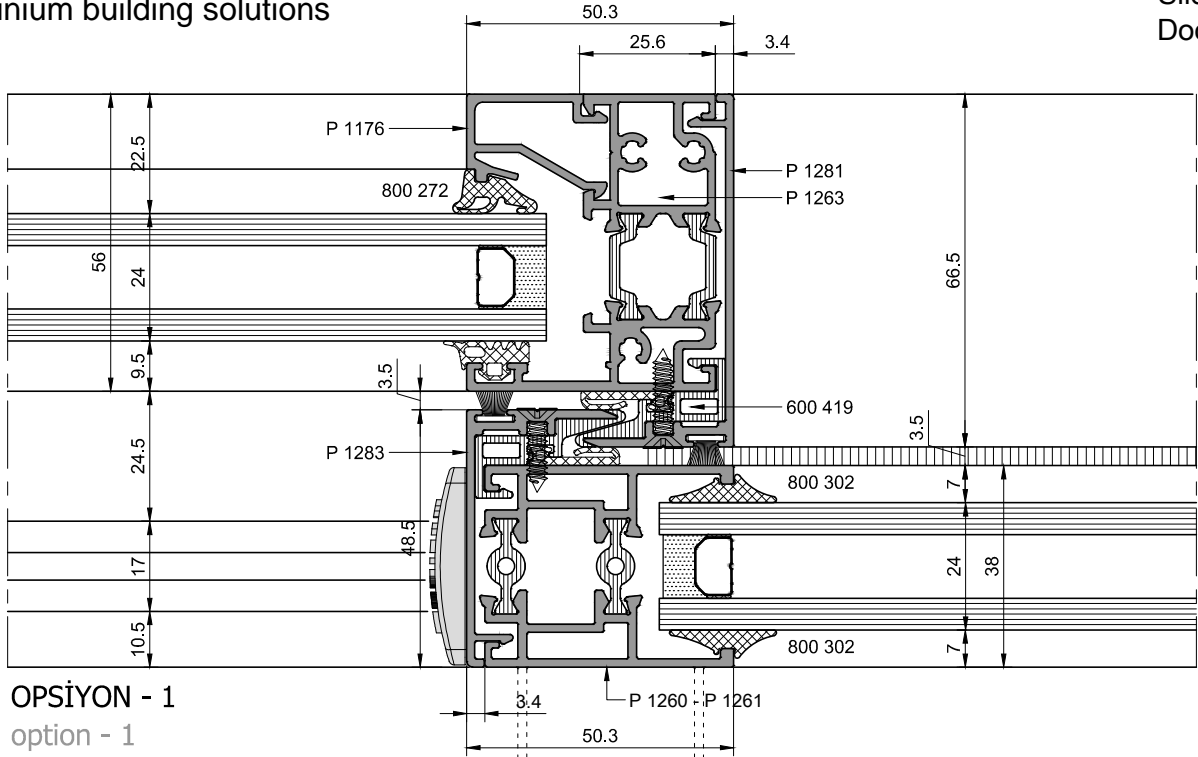

dış görünüş-external view

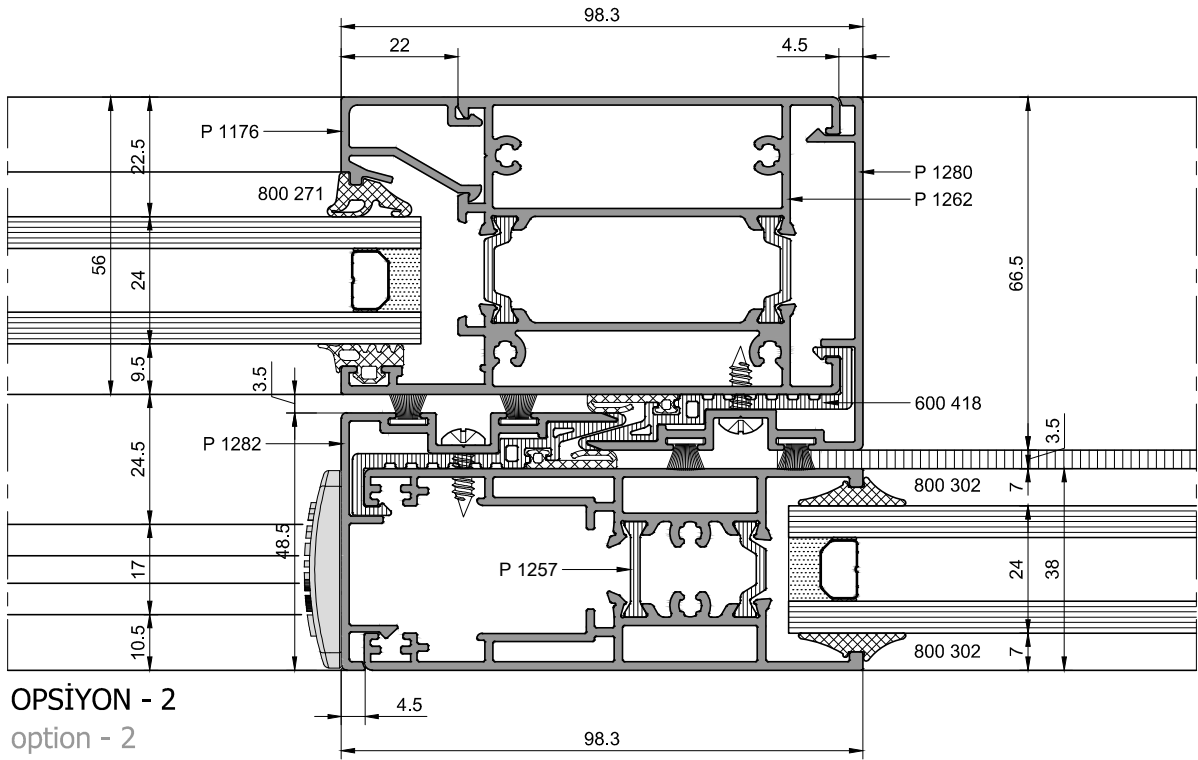

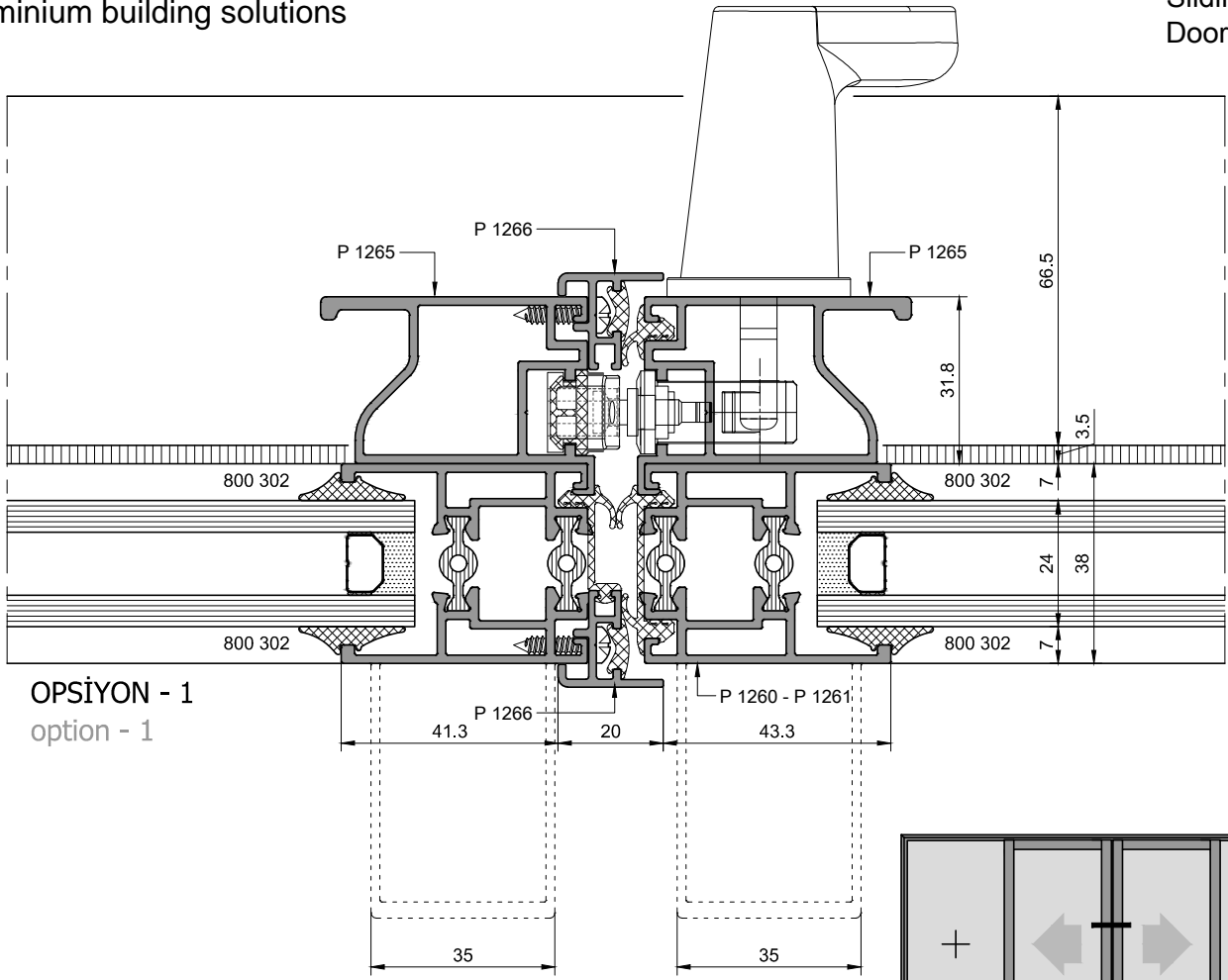

OPSİYON - 1
option - 1

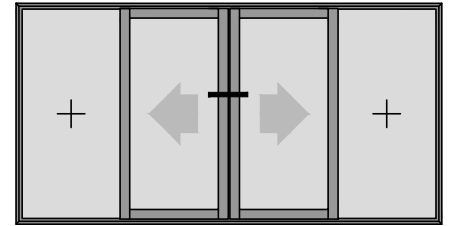

dış görünüş-external view

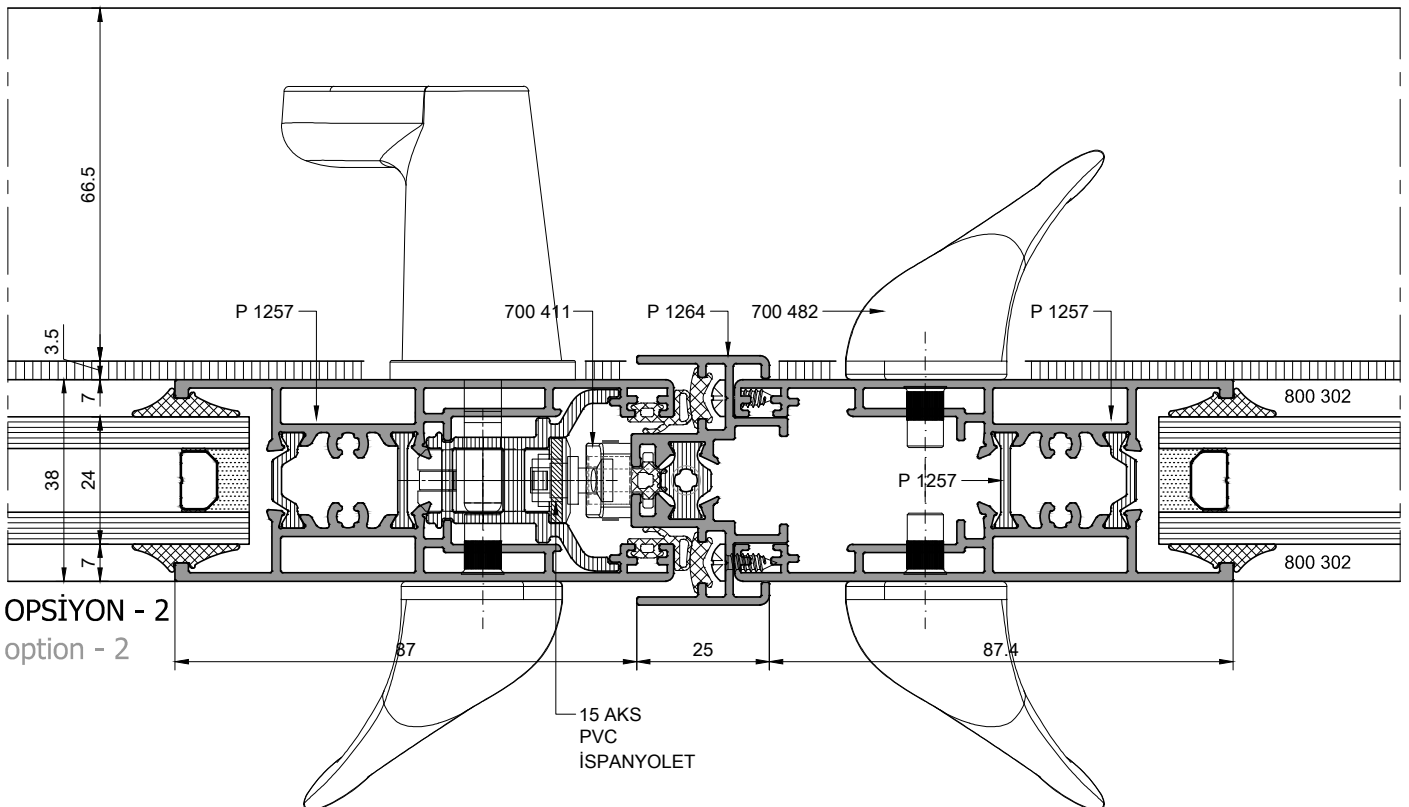

OPSİYON - 2
option - 2

15 AKS
PVC
İSPANYOLET

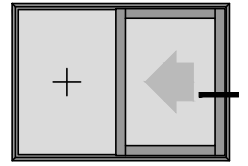

dış görünüş-external view

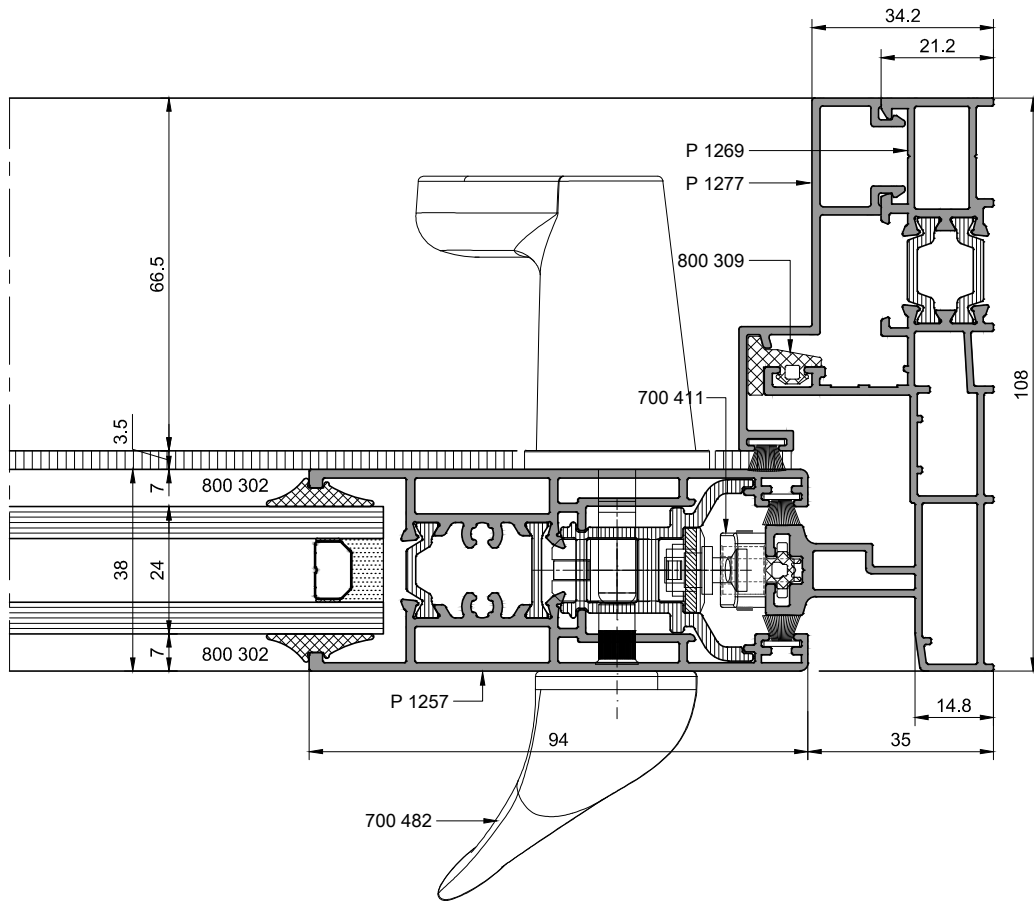

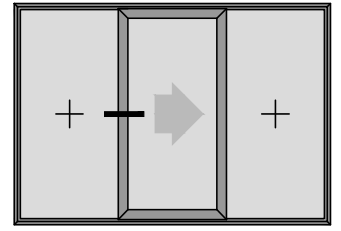

dış görünüş-external view

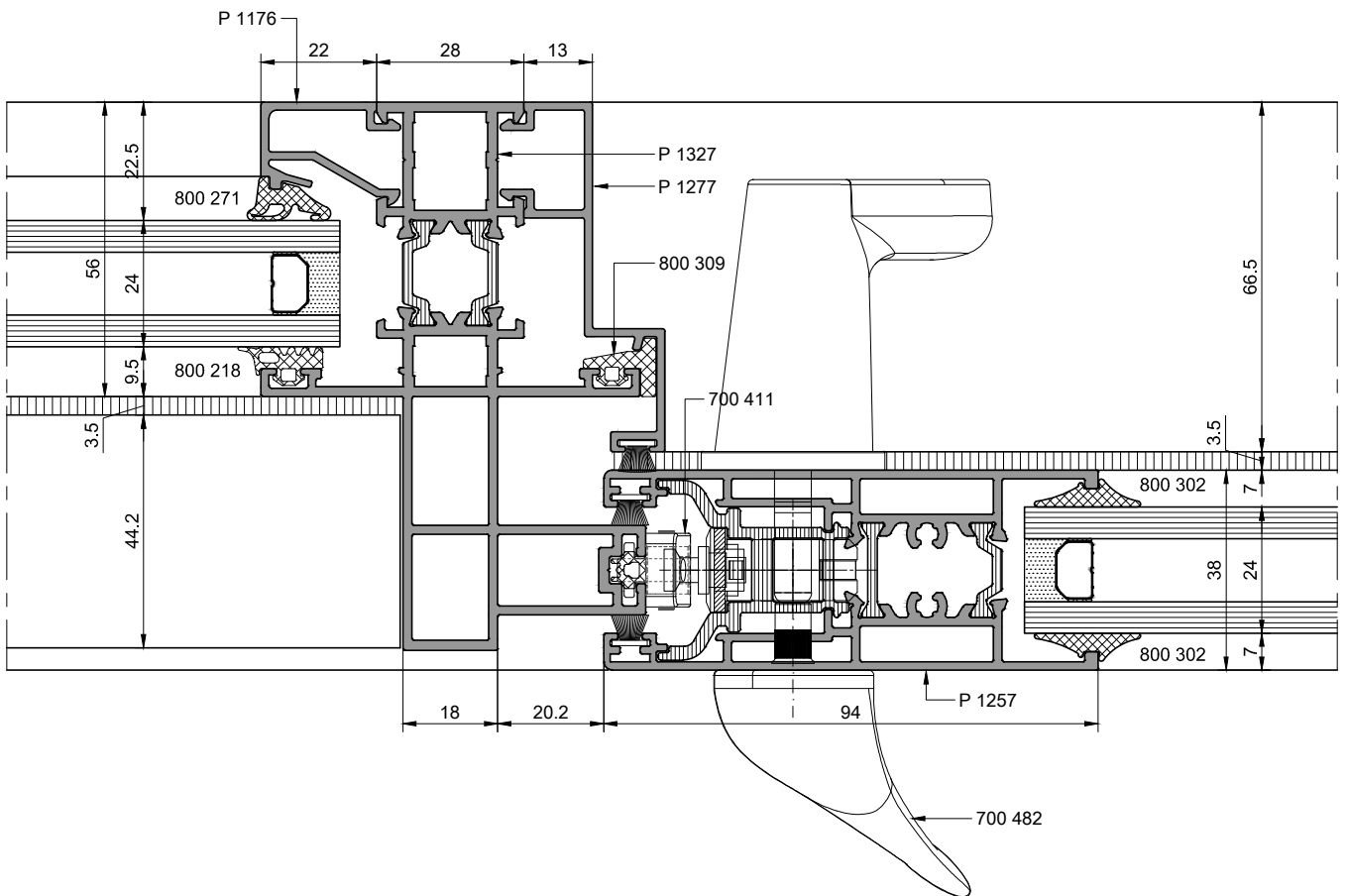

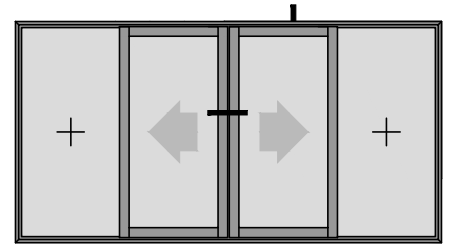
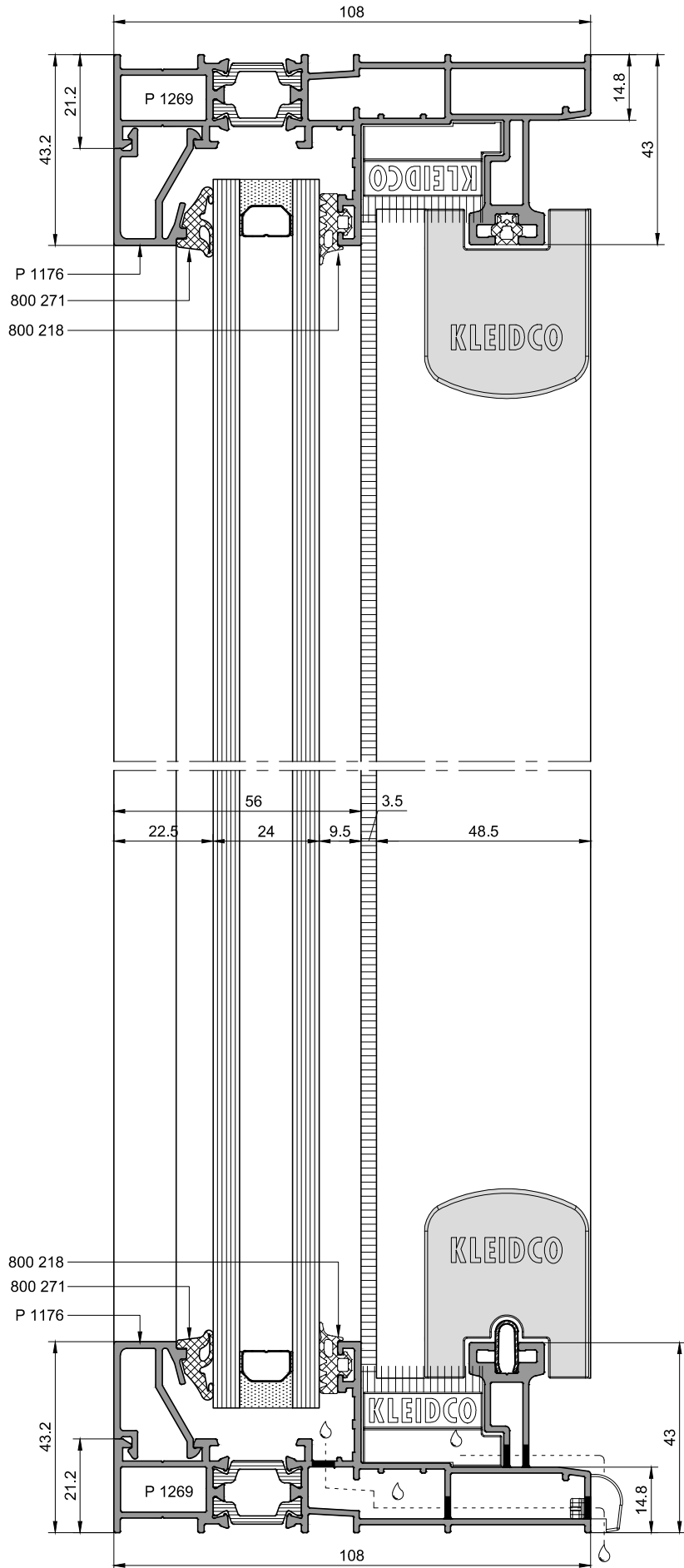

dış görünüş-external view

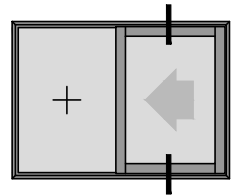
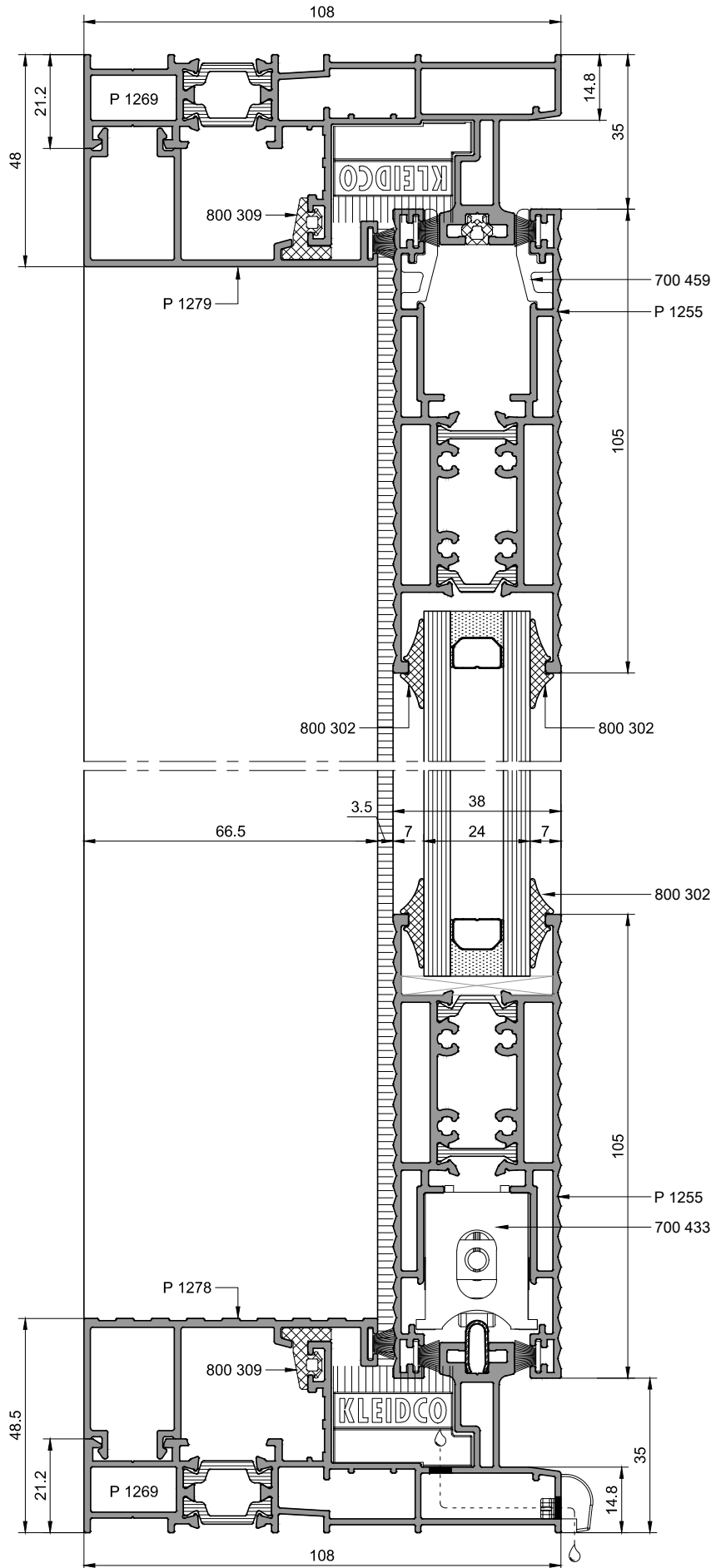

dış görünüş-external view

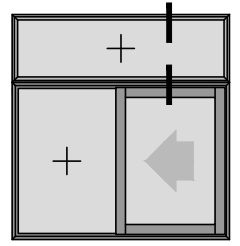
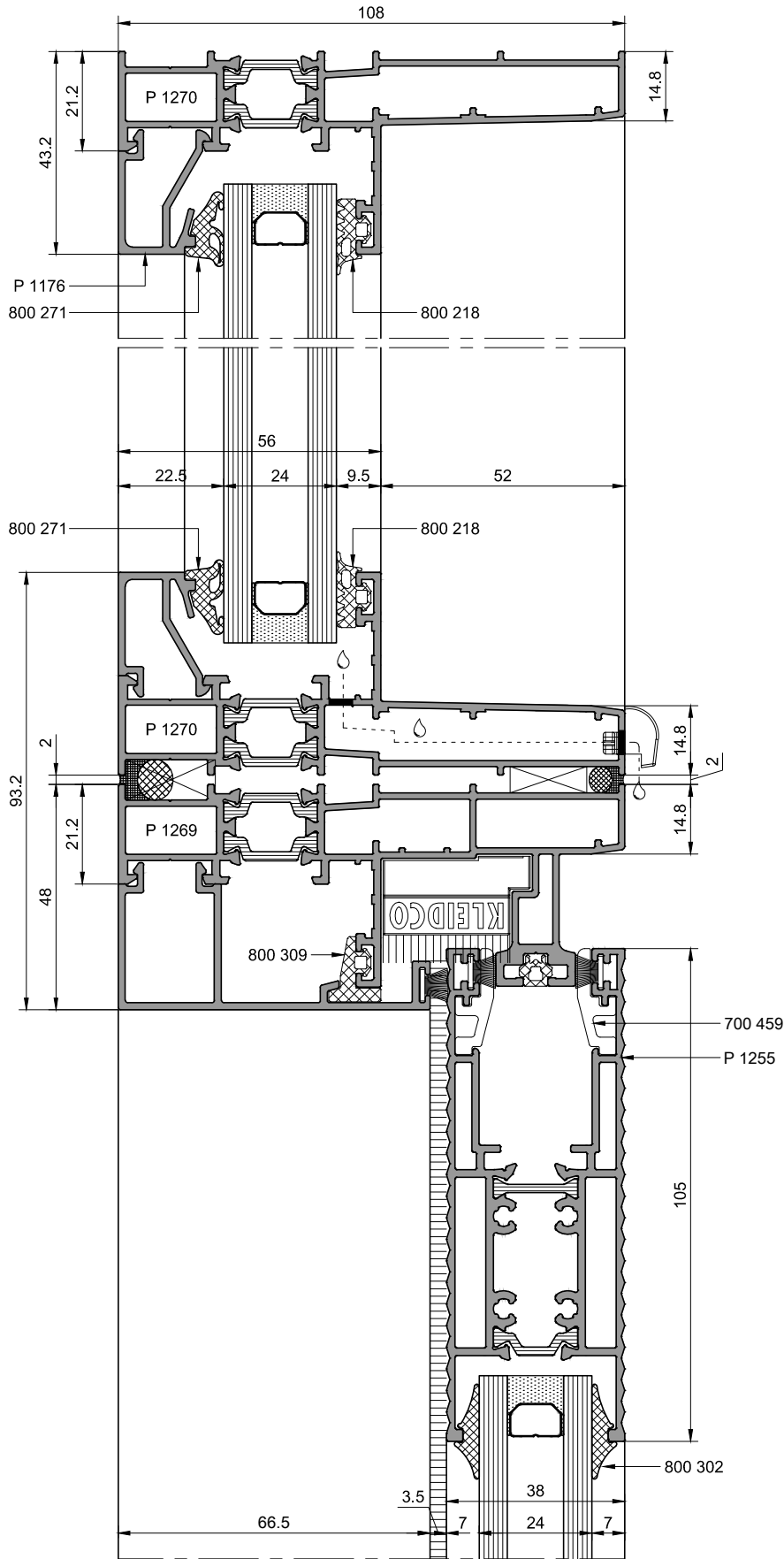

dış görünüş-external view

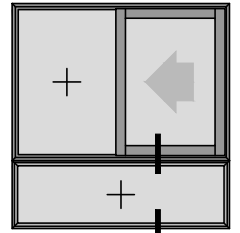

dış görünüş-external view

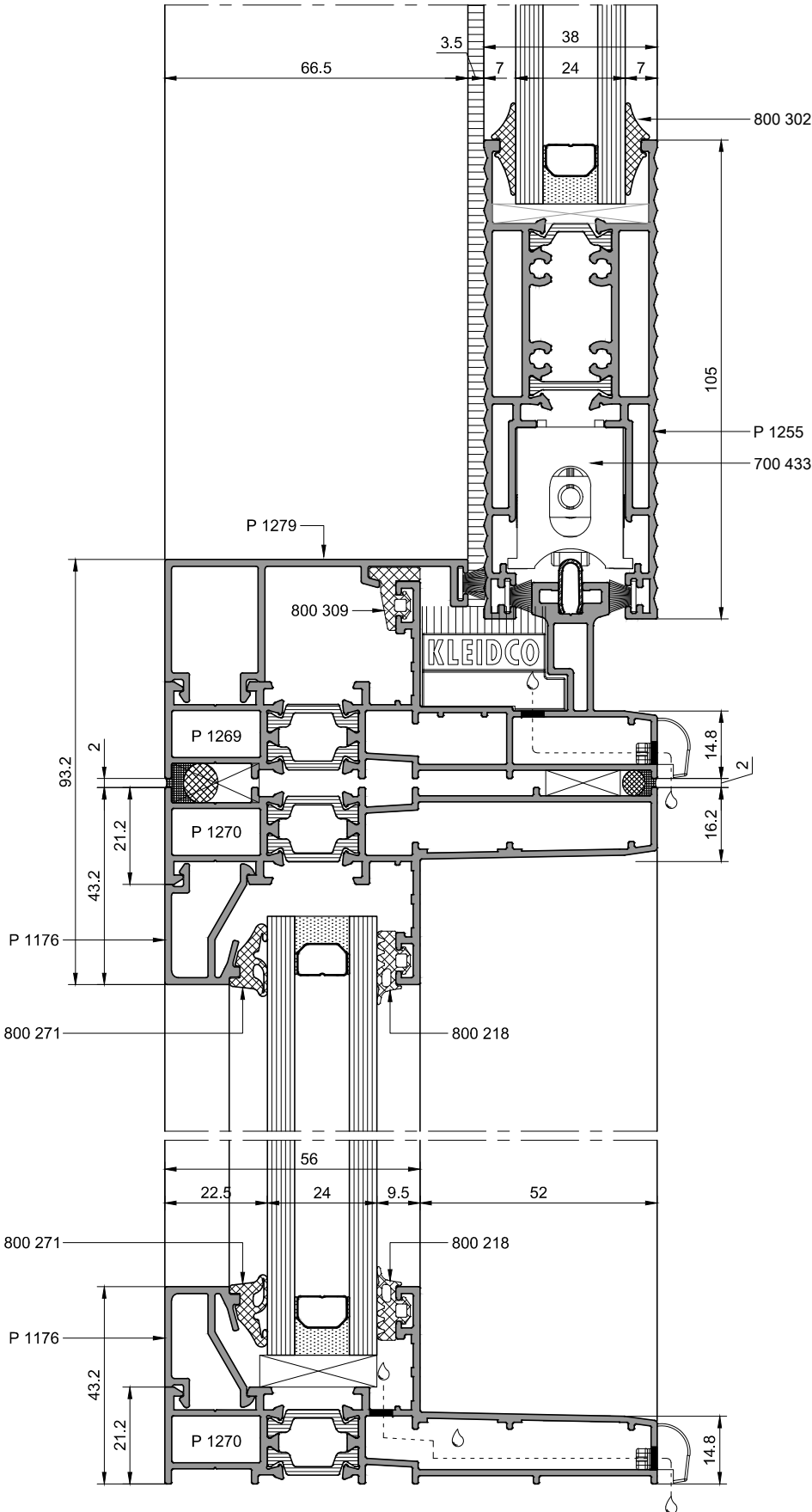

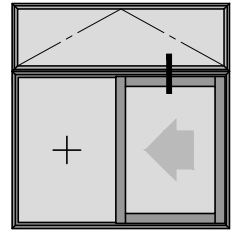
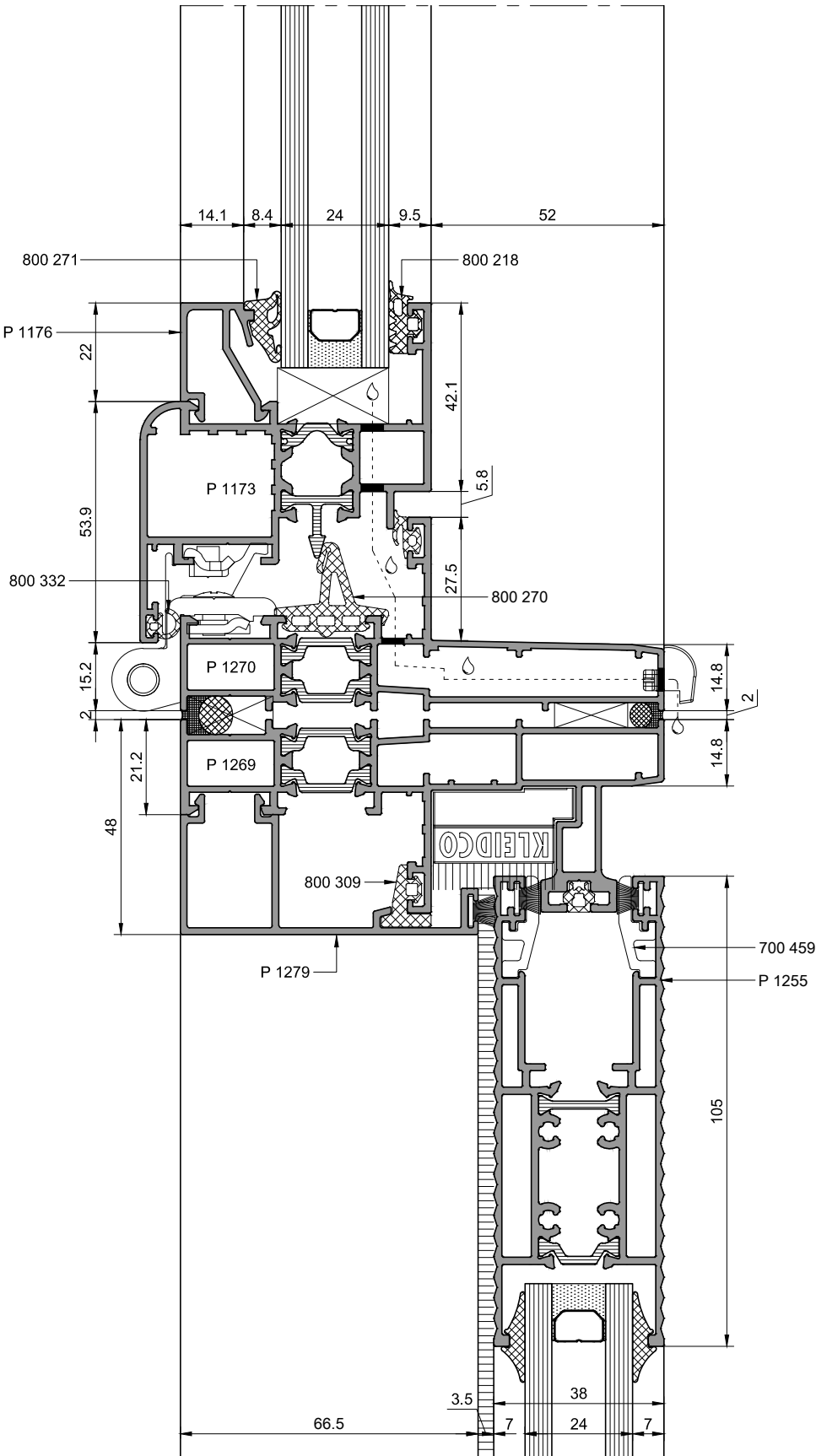

dış görünüş-external view

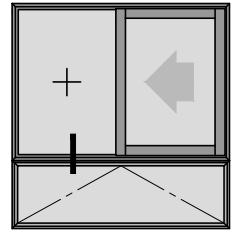

dış görünüş-external view

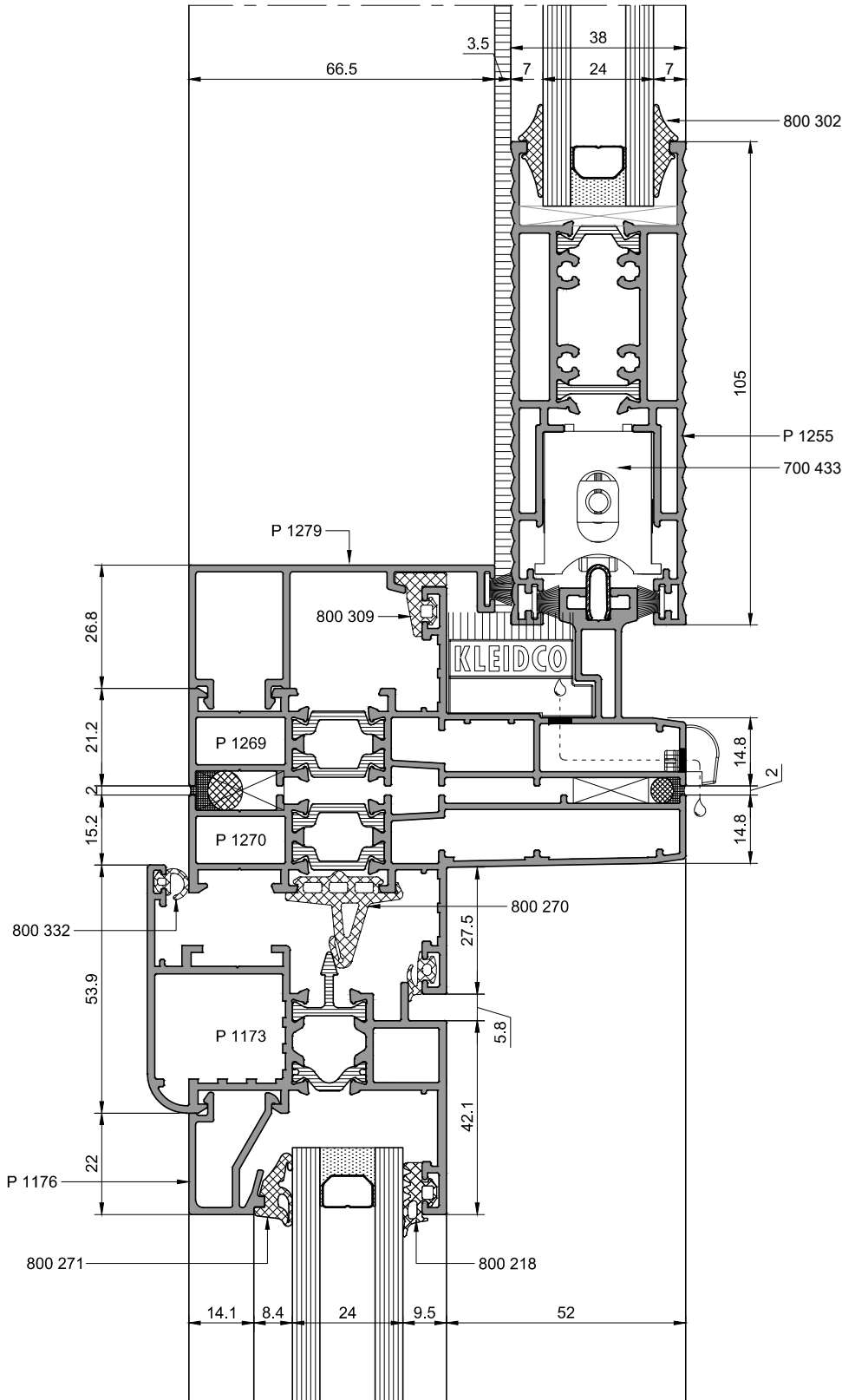

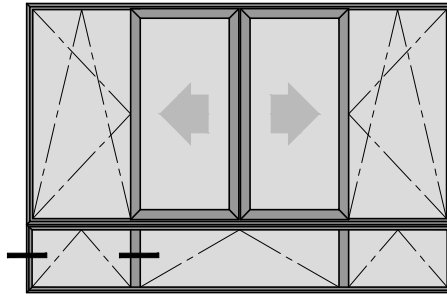

dış görünüş-external view

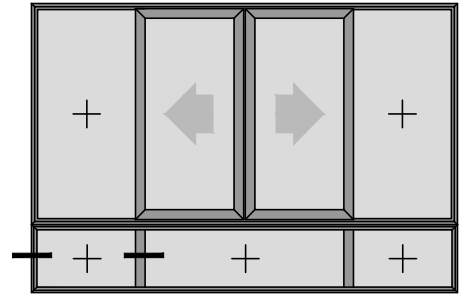

dış görünüş-external view

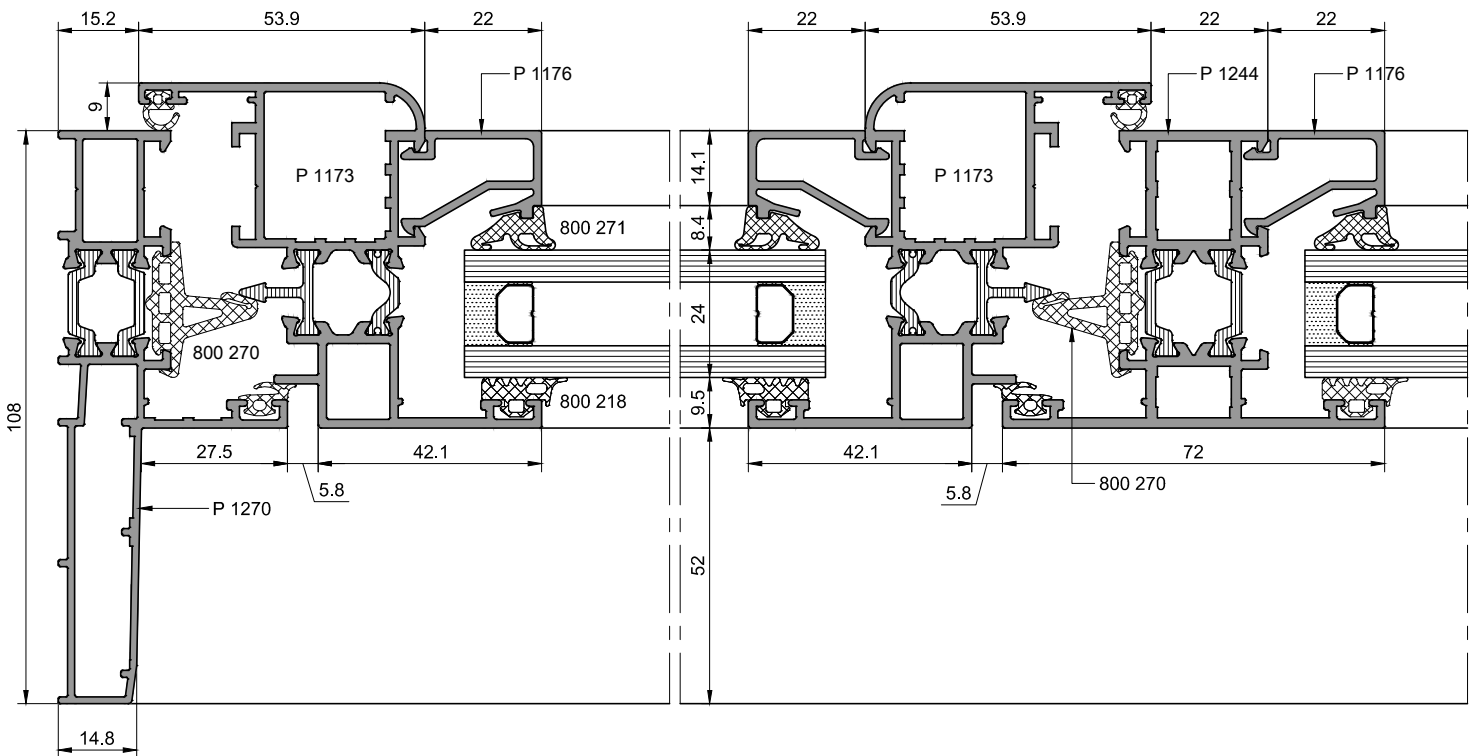
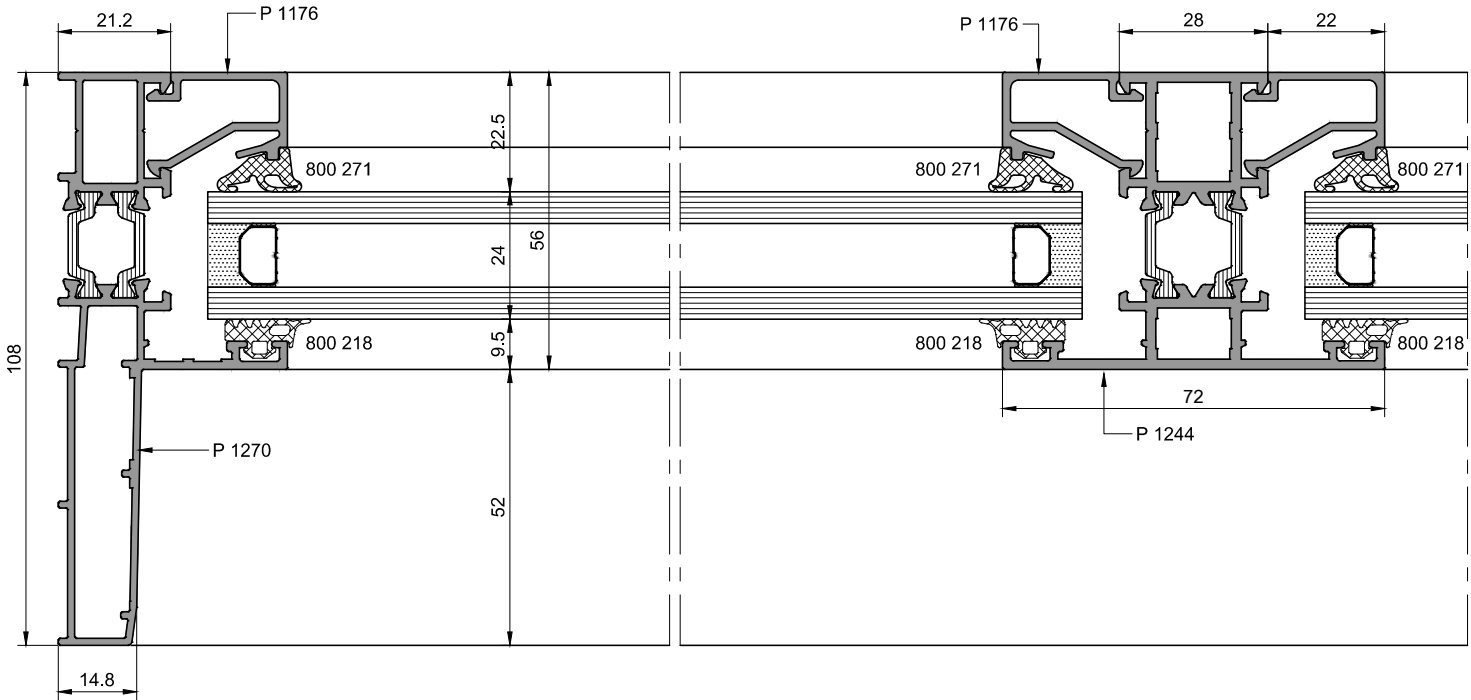

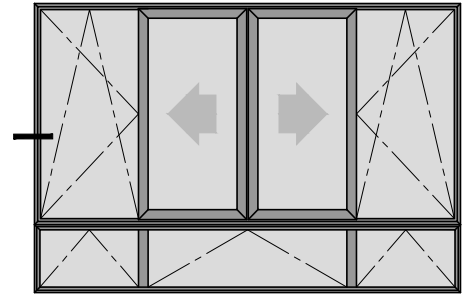

dış görünüş-external view

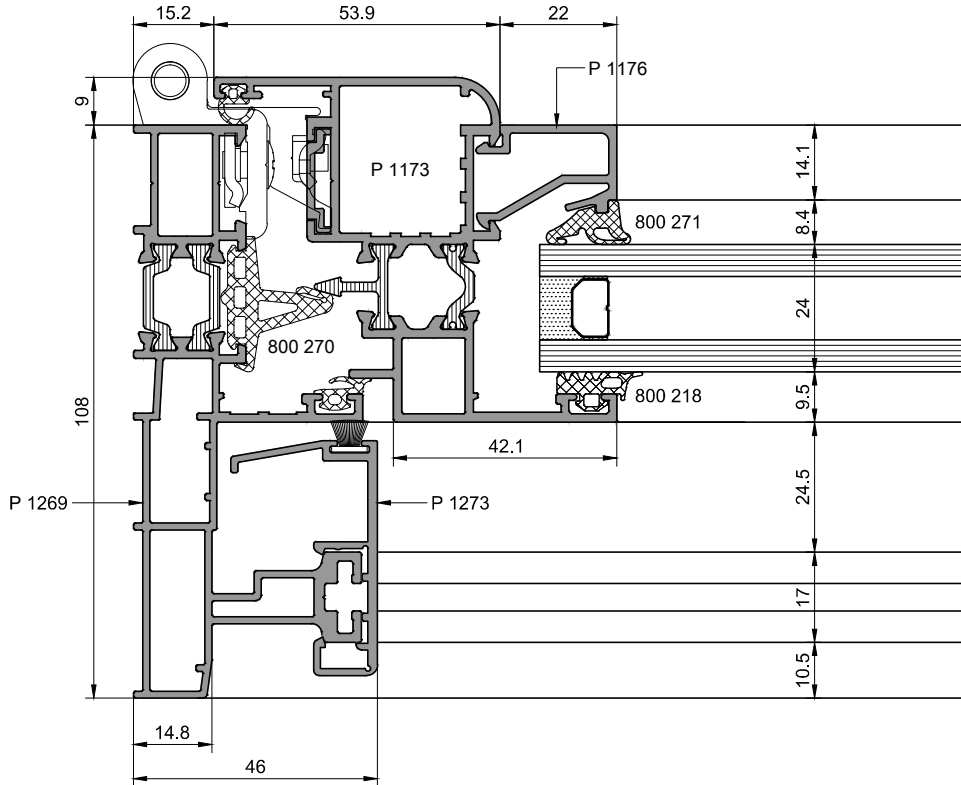

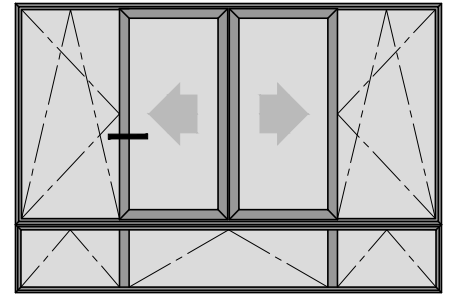

dış görünüş-external view

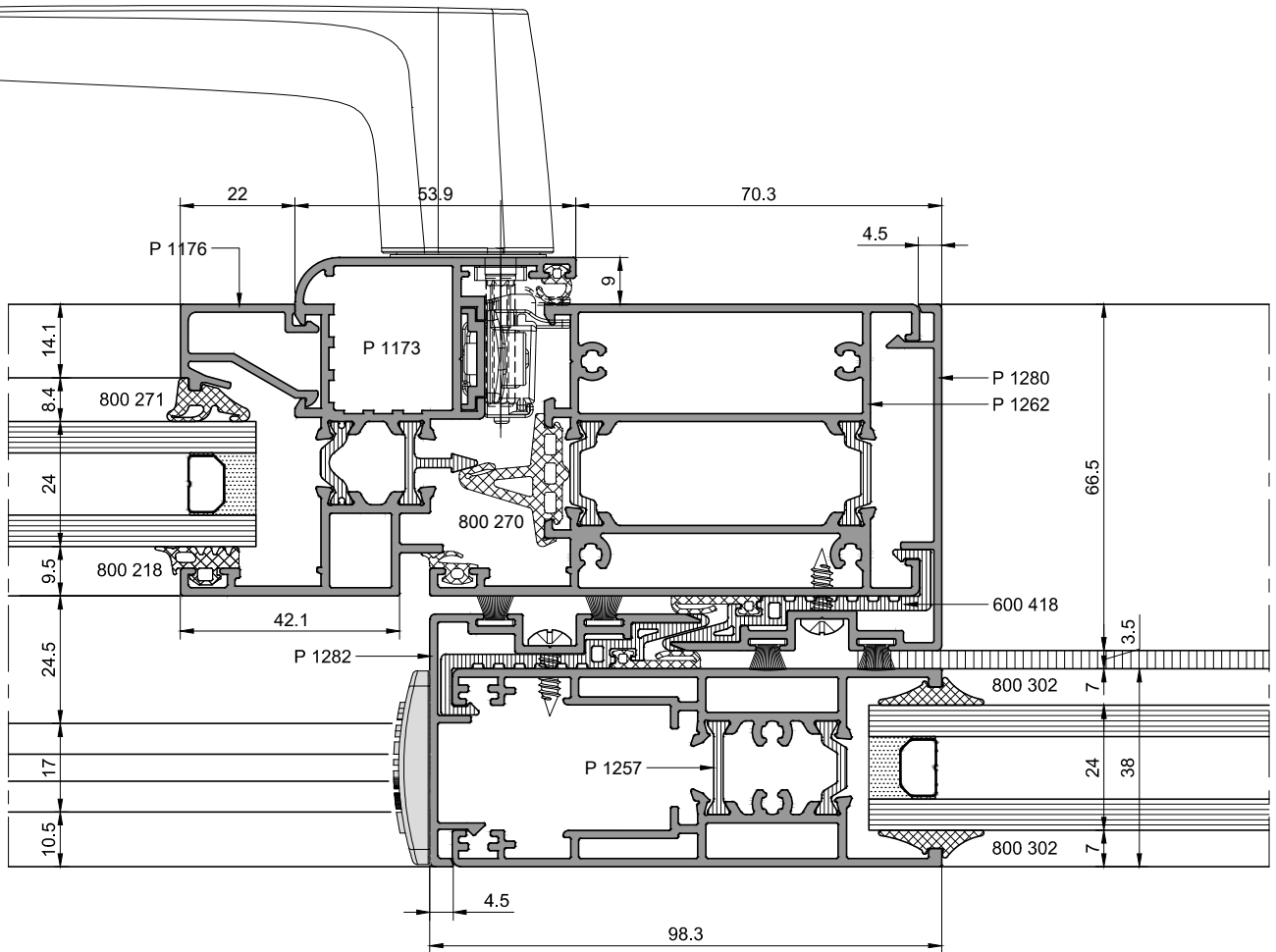

NOVA
BASİT SÜRME KAPI ve PENCERE SİSTEMİ
SIMPLE SLIDE DOOR and WINDOW SYSTEM

TEK RAYLI KASA ve İNCE KANATLI
SİSTEM DETAYLARI
SINGLE TRACK RAIL with SLIM SASH
PRINCIPAL SECTION

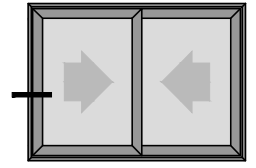

dış görünüş-external view

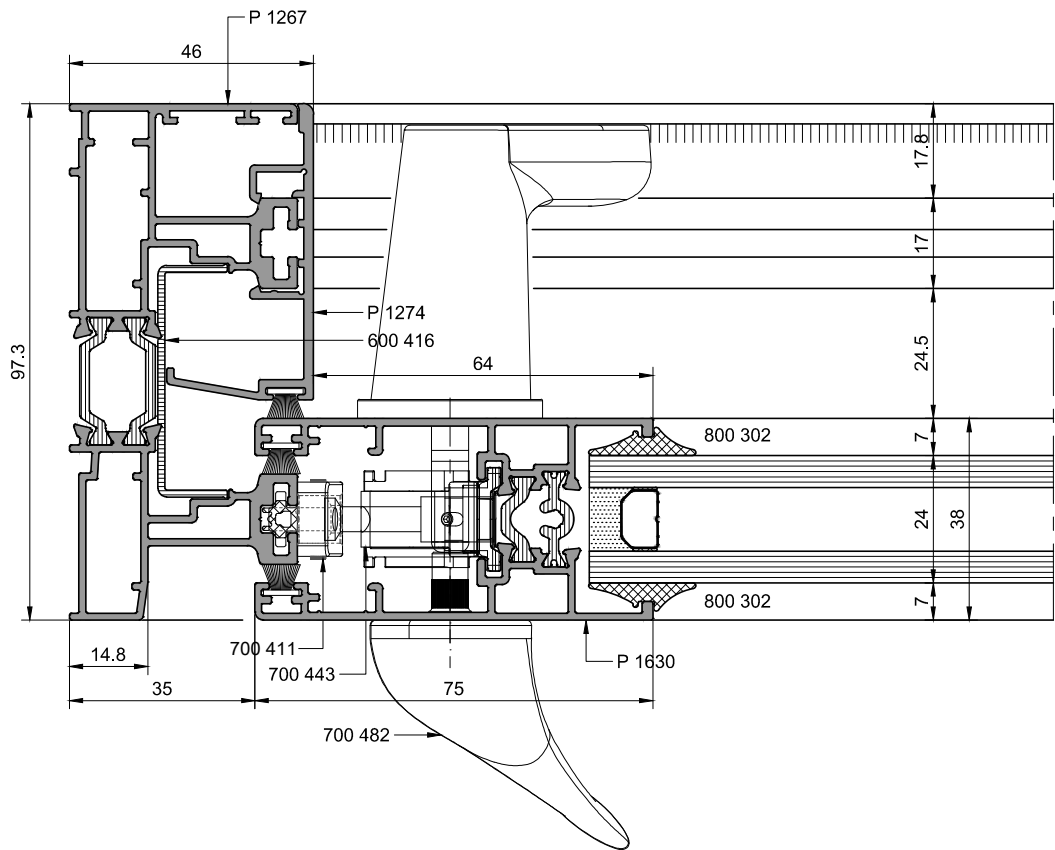

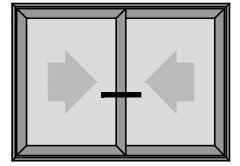

dış görünüş - external view

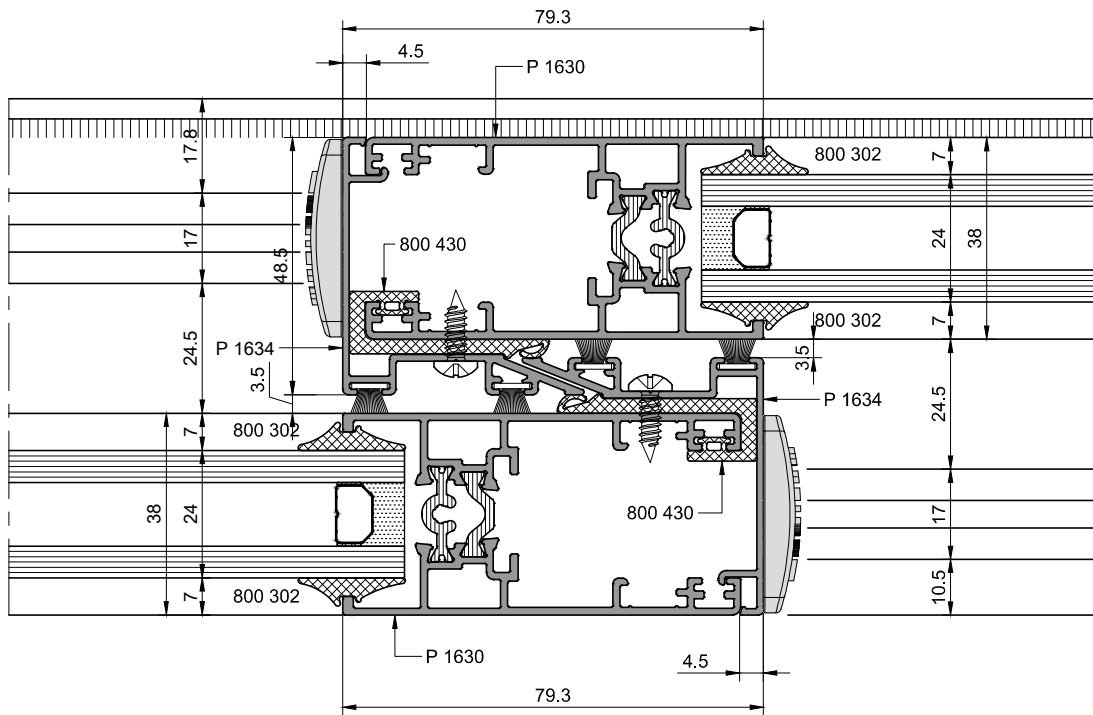

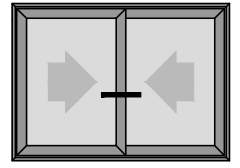

dış görünüş-external view

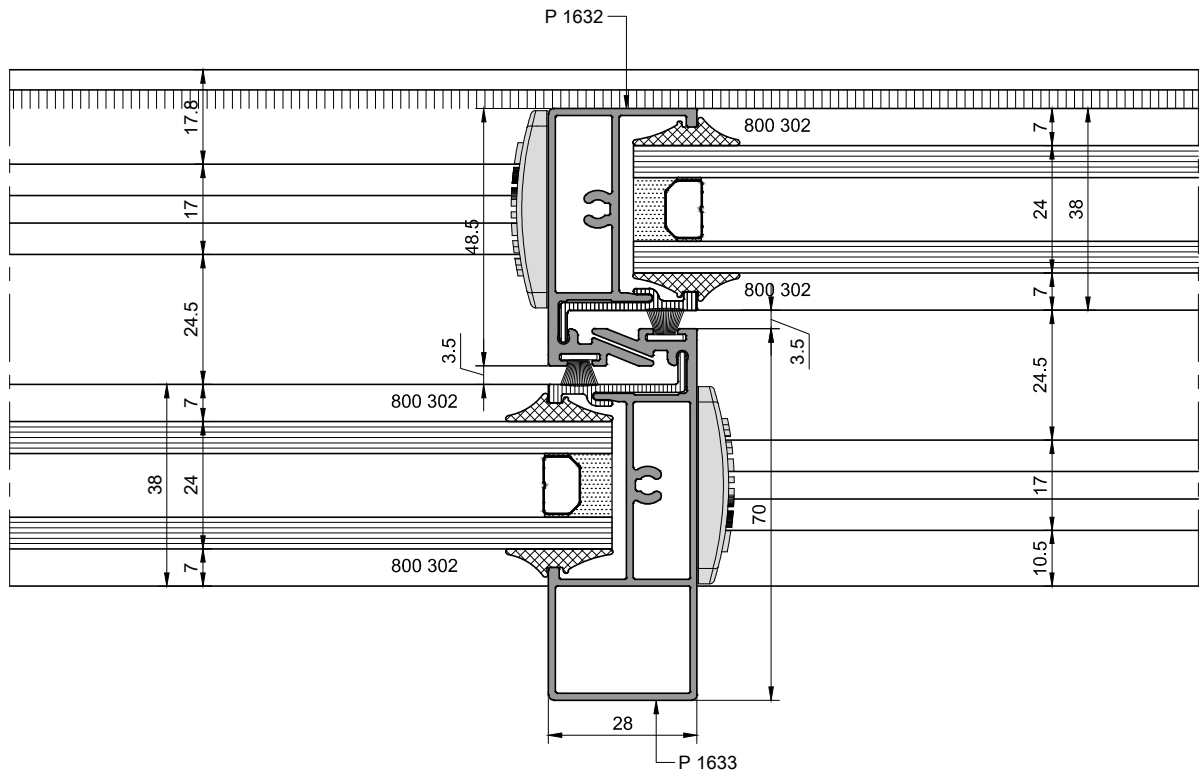

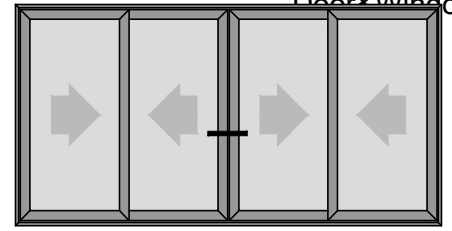

dış görünüş-external view

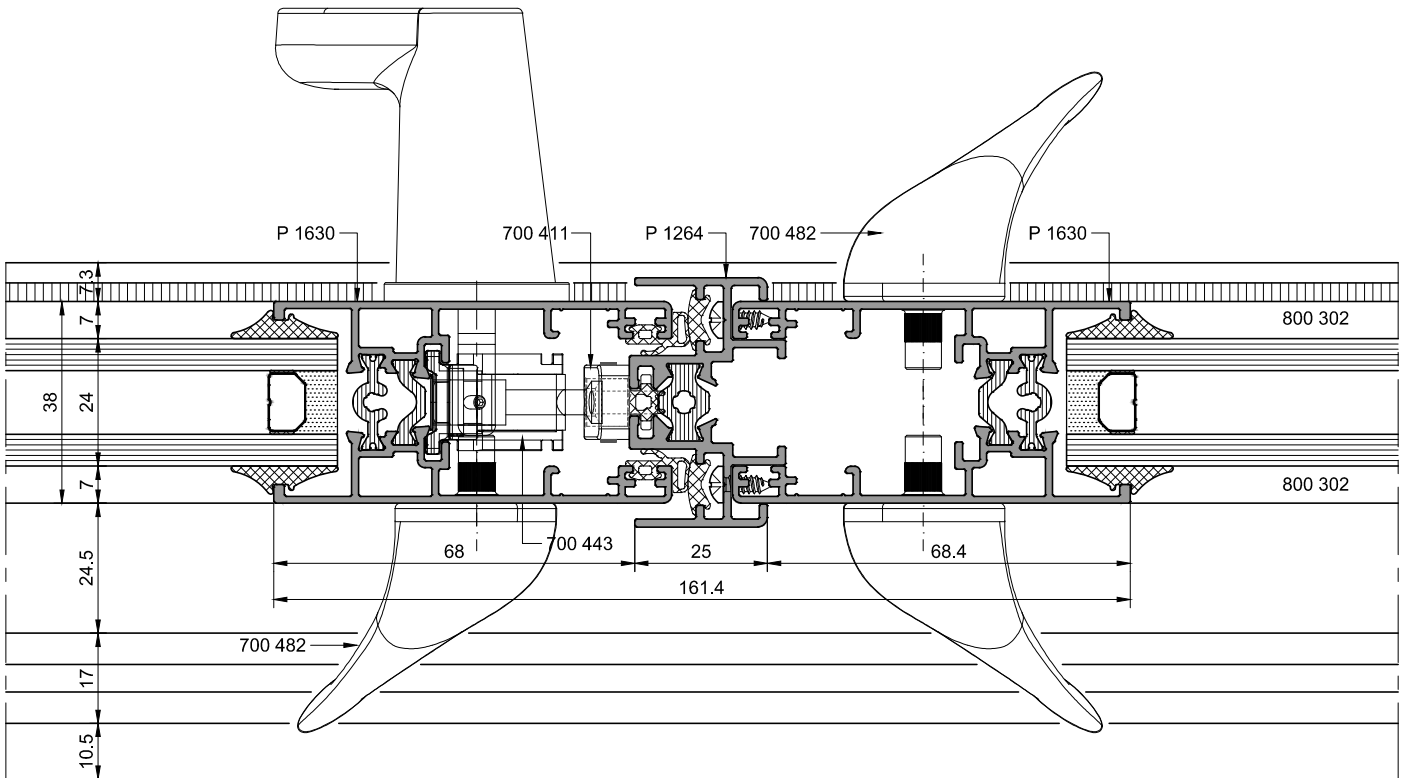

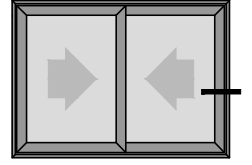

dış görünüş - external view

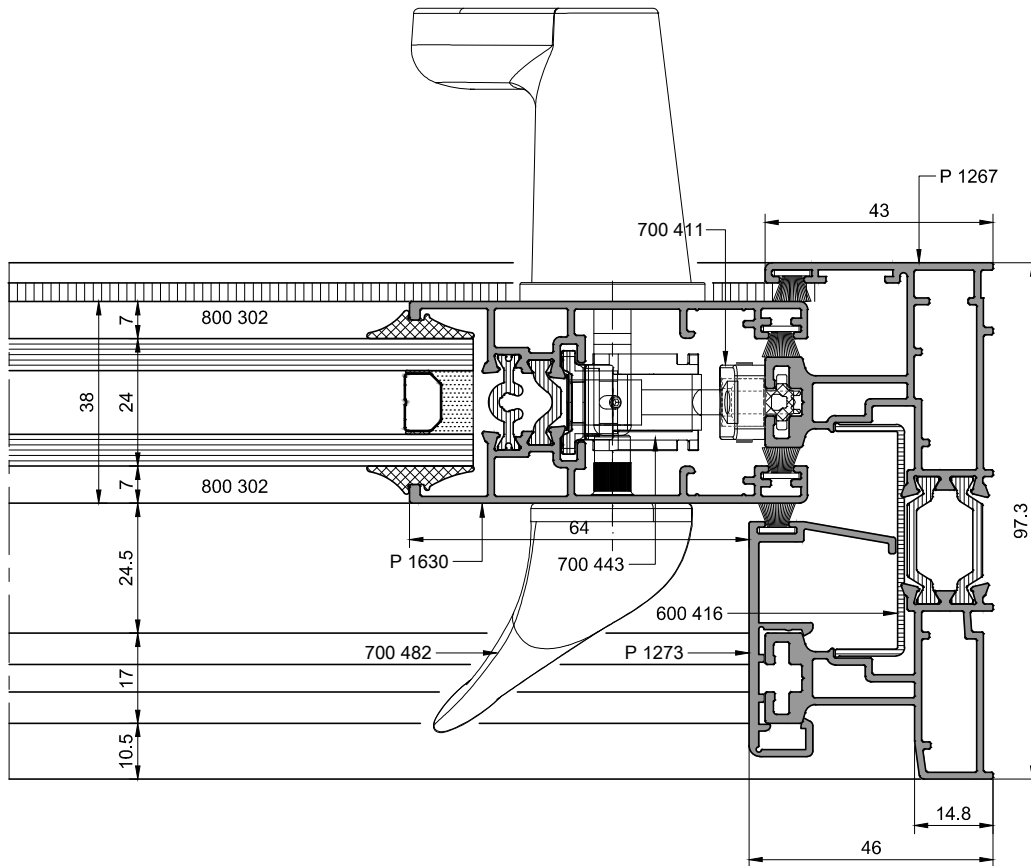

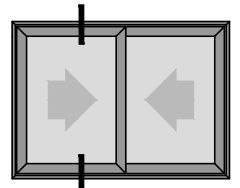
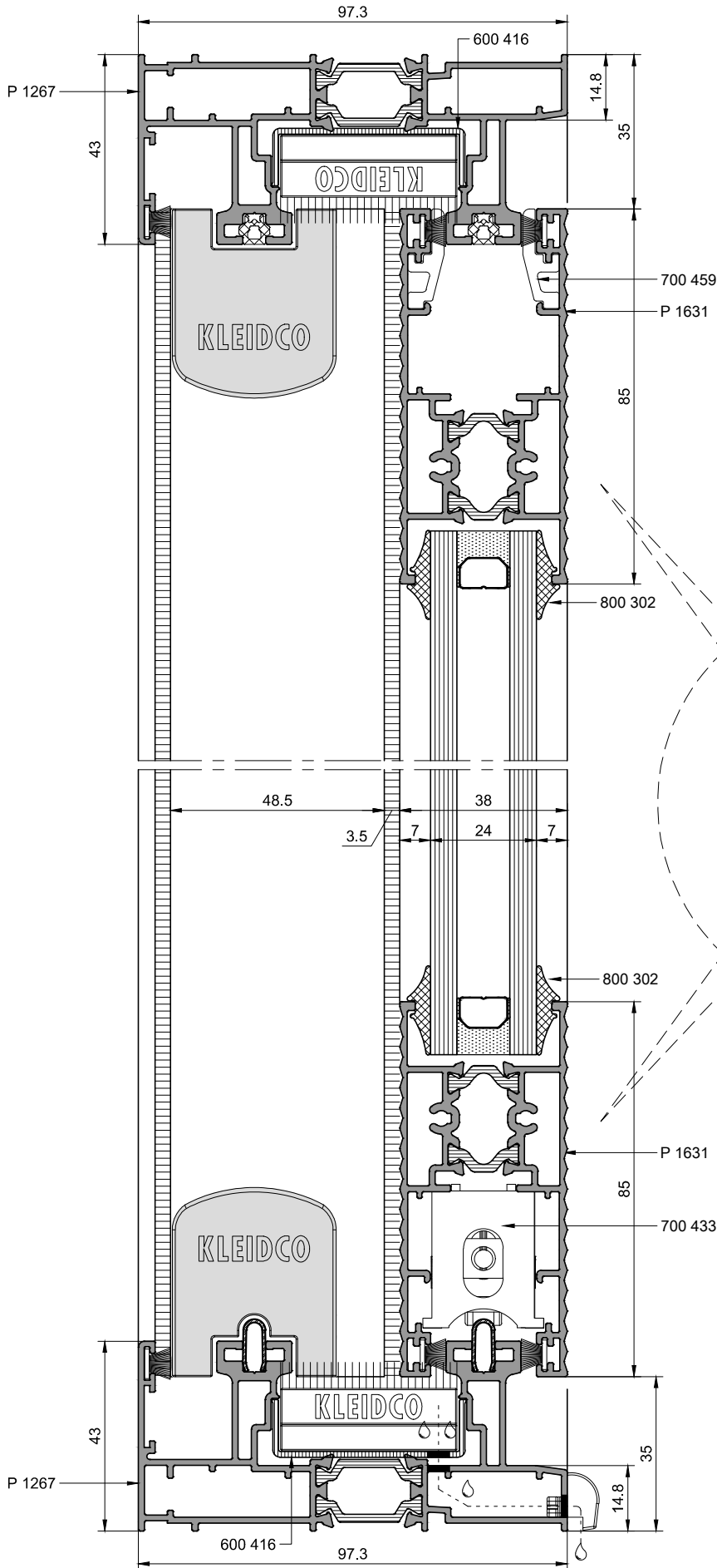

dış görünüş-external view

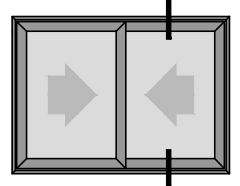
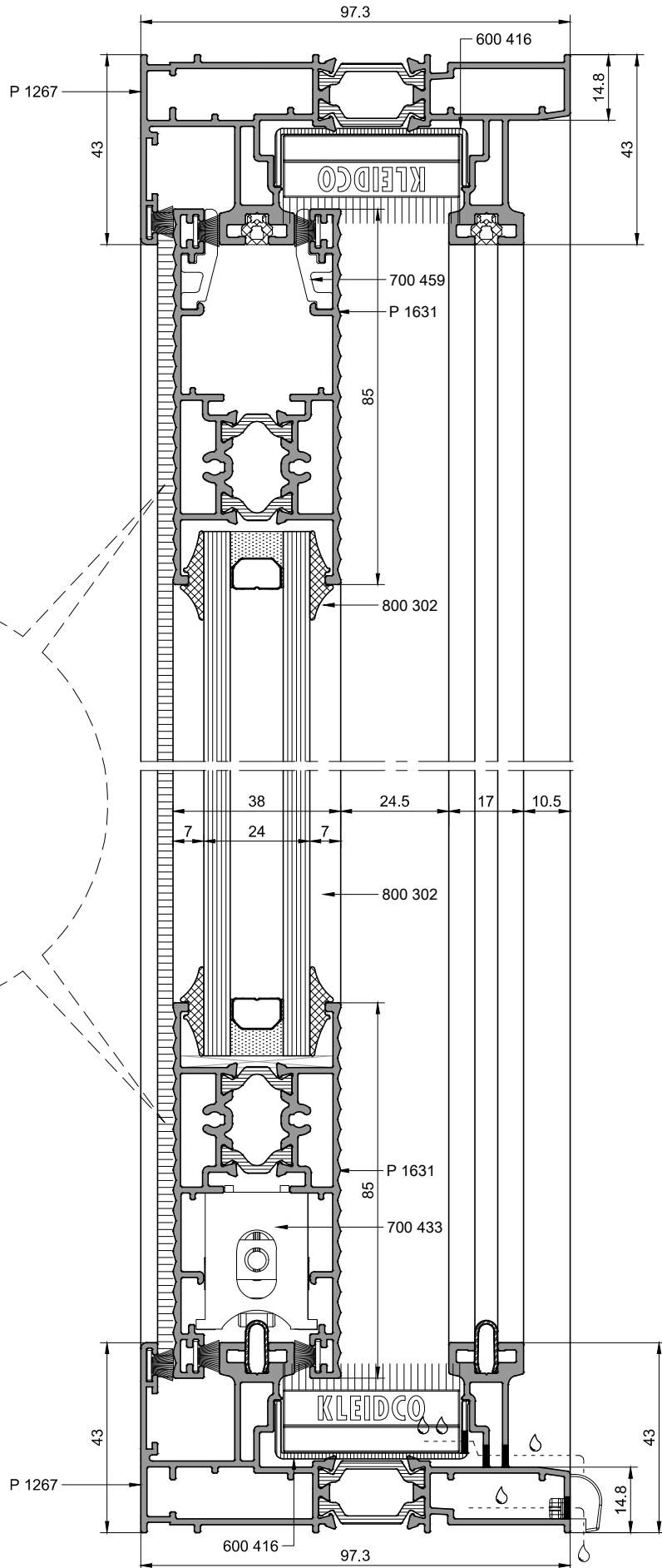

dış görünüş-external view

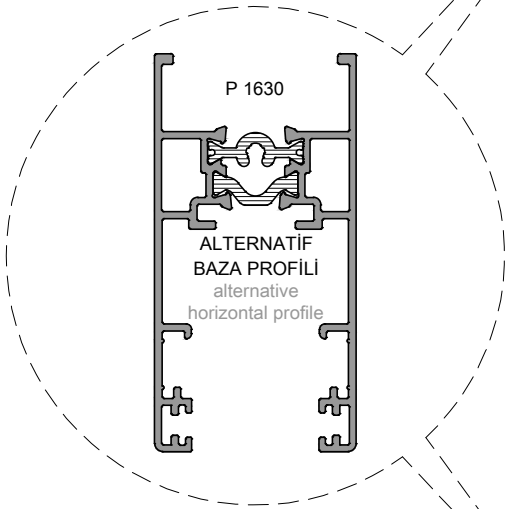

NOVA
BASİT SÜRME KAPI ve PENCERE SİSTEMİ
SIMPLE SLIDE DOOR and WINDOW SYSTEM

ÇİFT RAYLI KASA SİSTEM DETAYLARI
DOUBLE TRACK RAIL PRINCIPAL SECTION

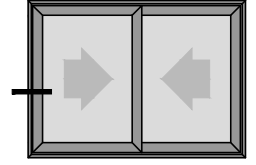

dış görünüş - external view

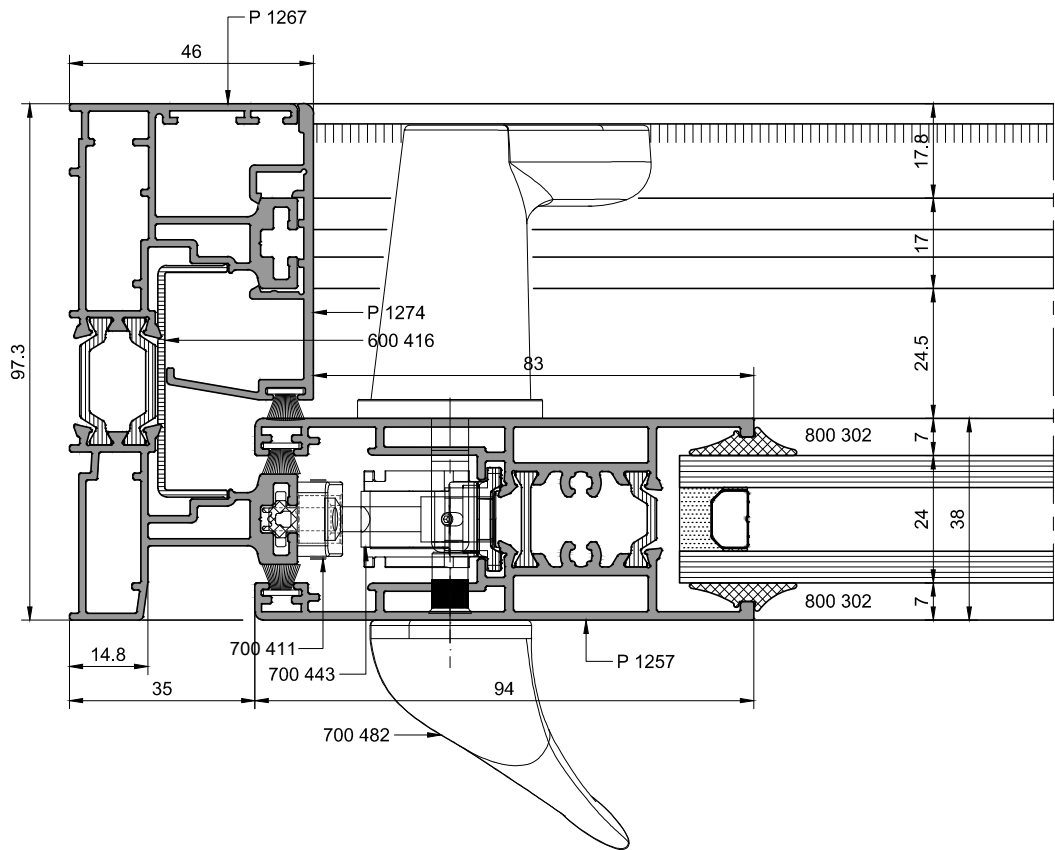

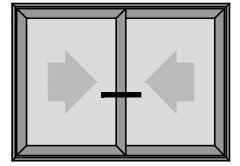

dış görünüş-external view

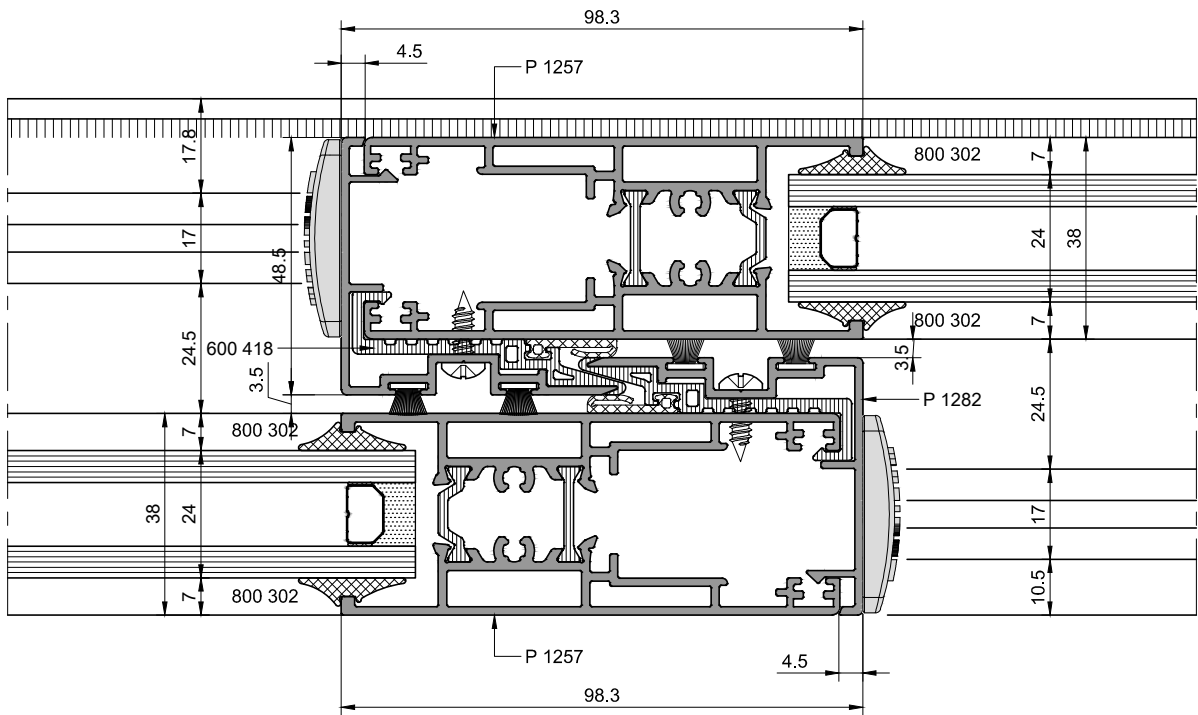

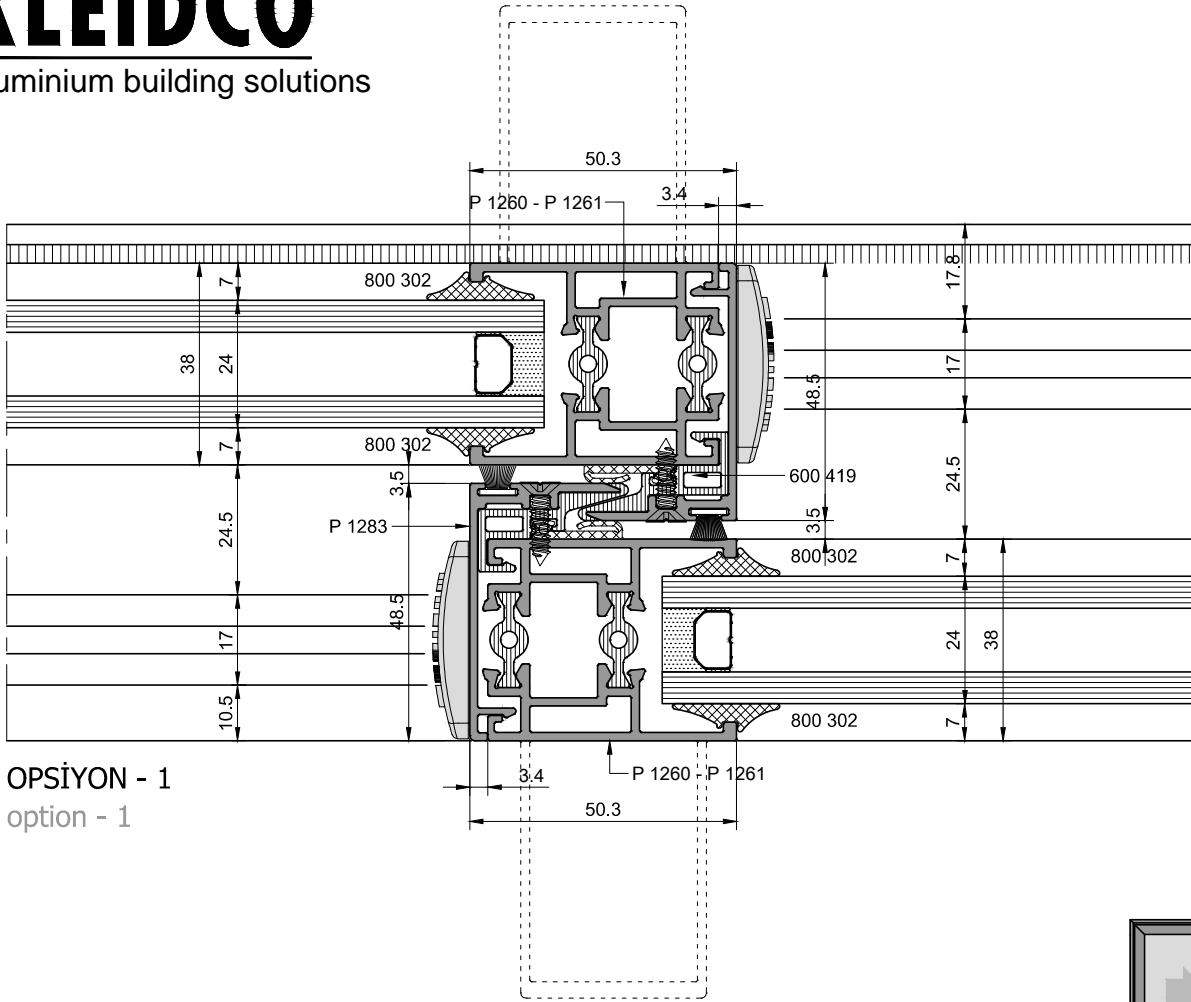

OPSİYON - 1
option - 1

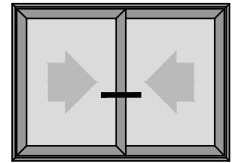

dış görünüş-external view

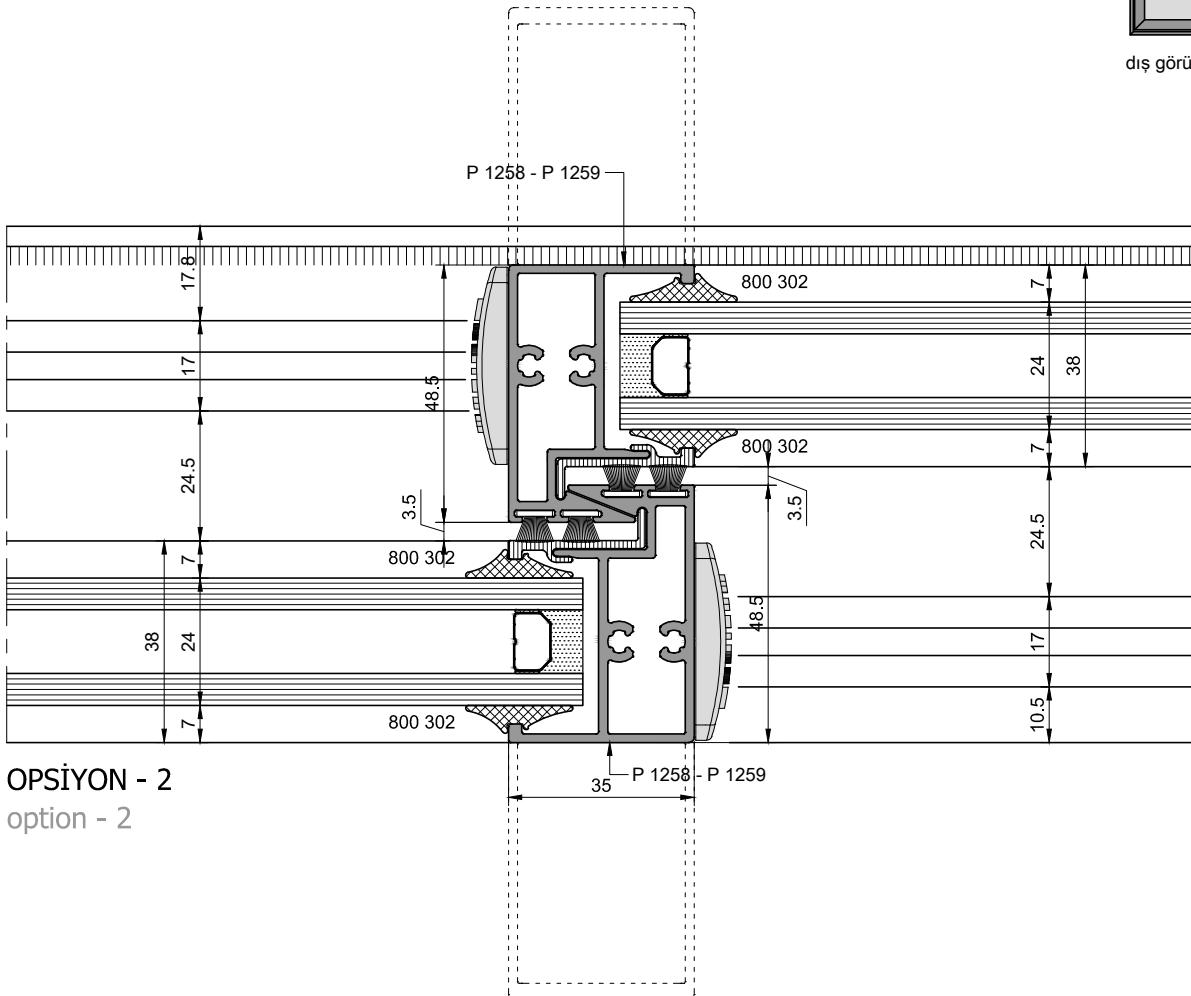

OPSİYON - 2
option - 2

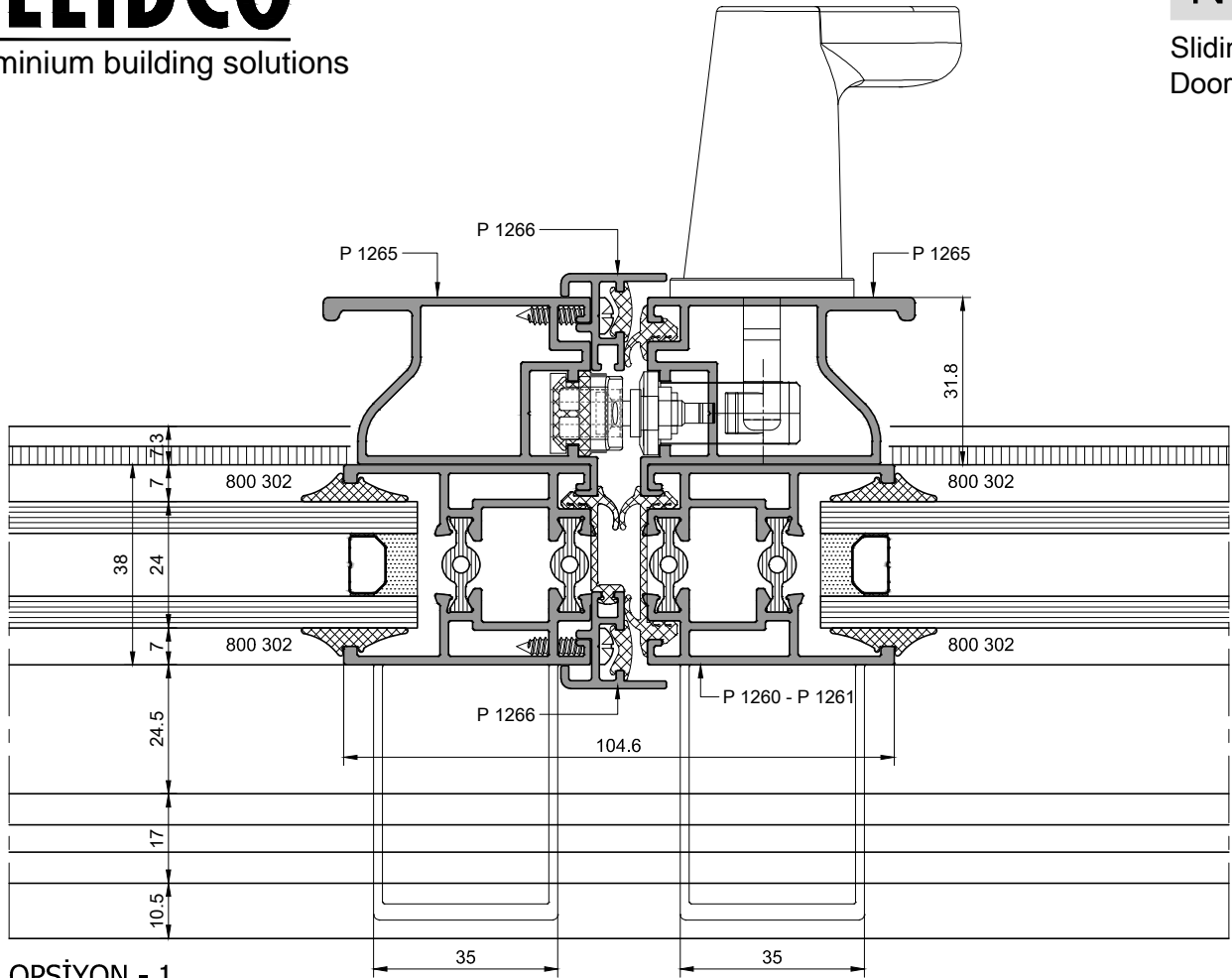

OPSIYON - 1
option - 1

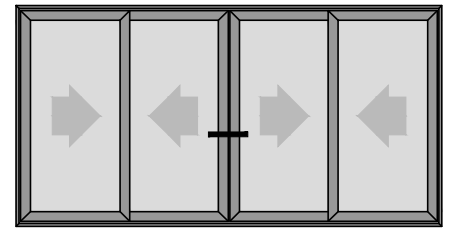

dış görünüş-external view

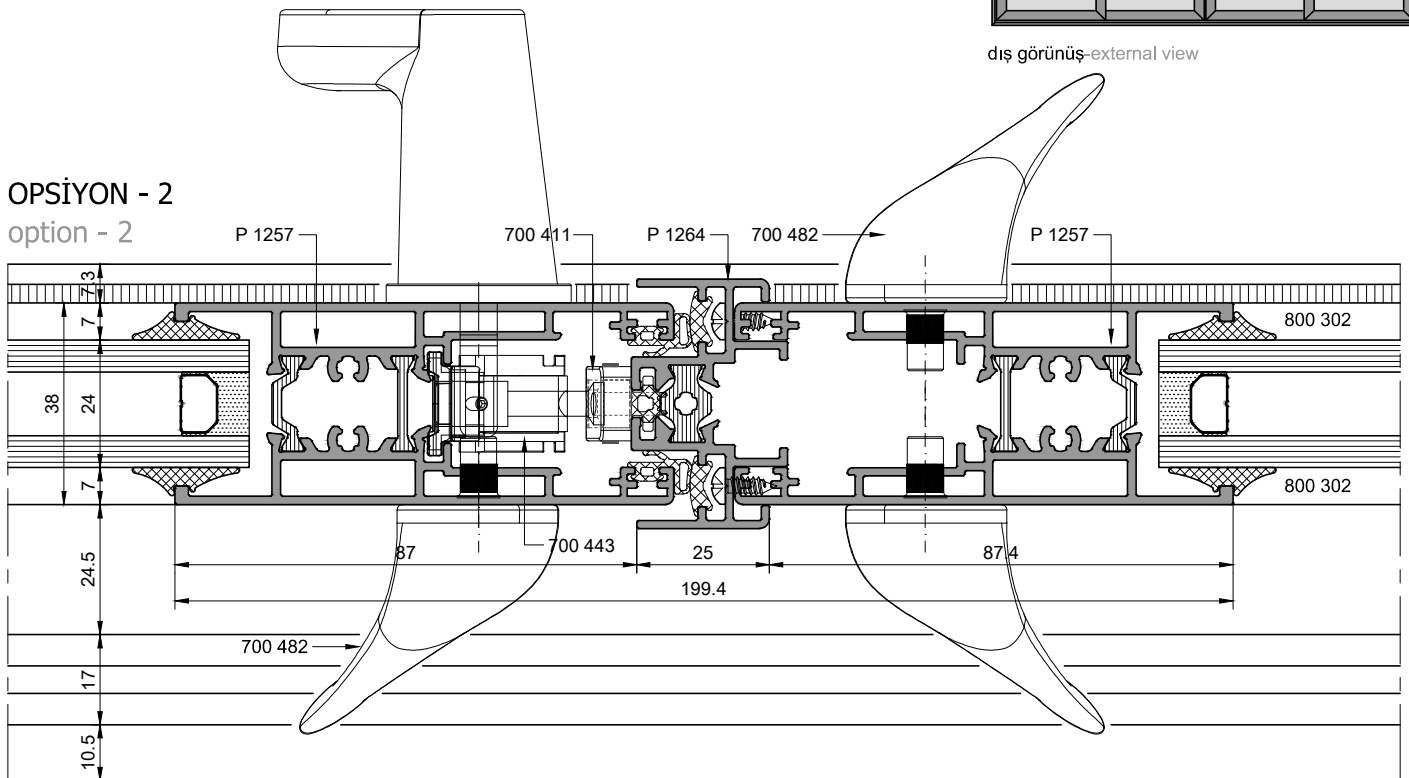

OPSIYON - 2
option - 2

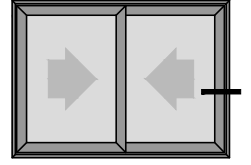

dış görünüş - external view

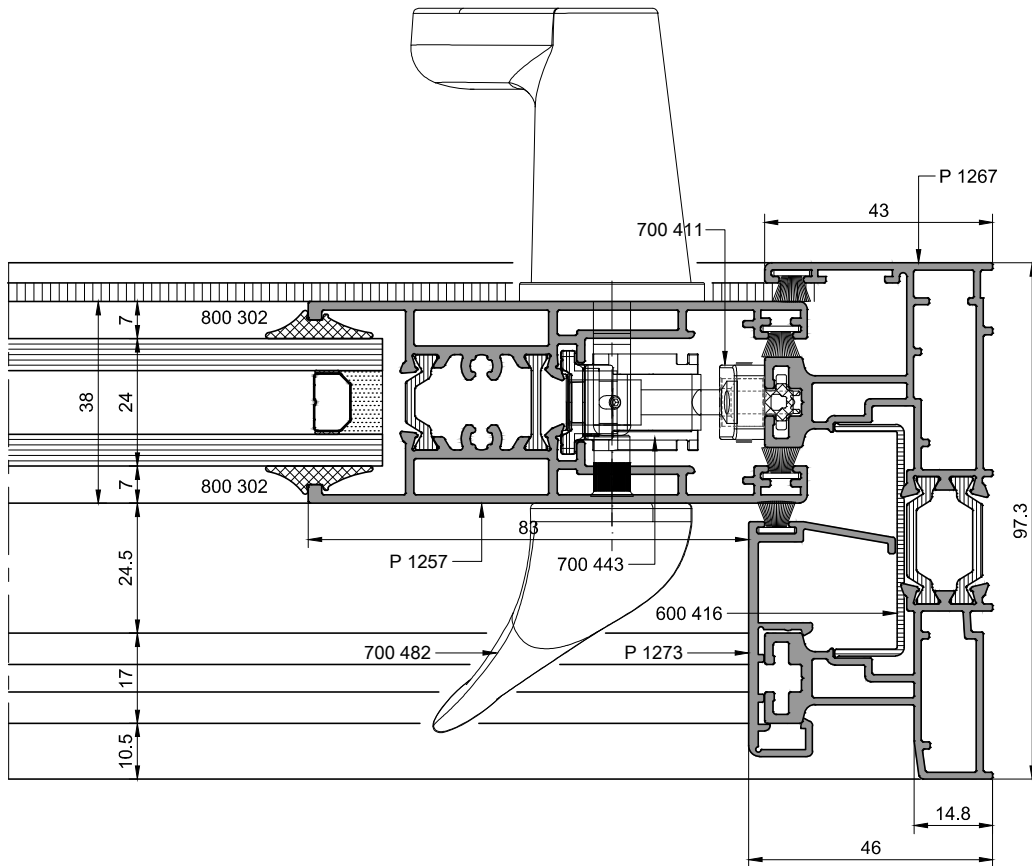

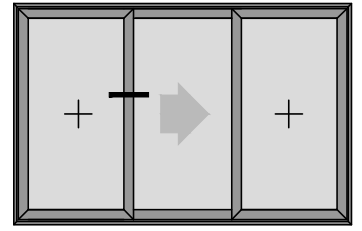

dış görünüş-external view

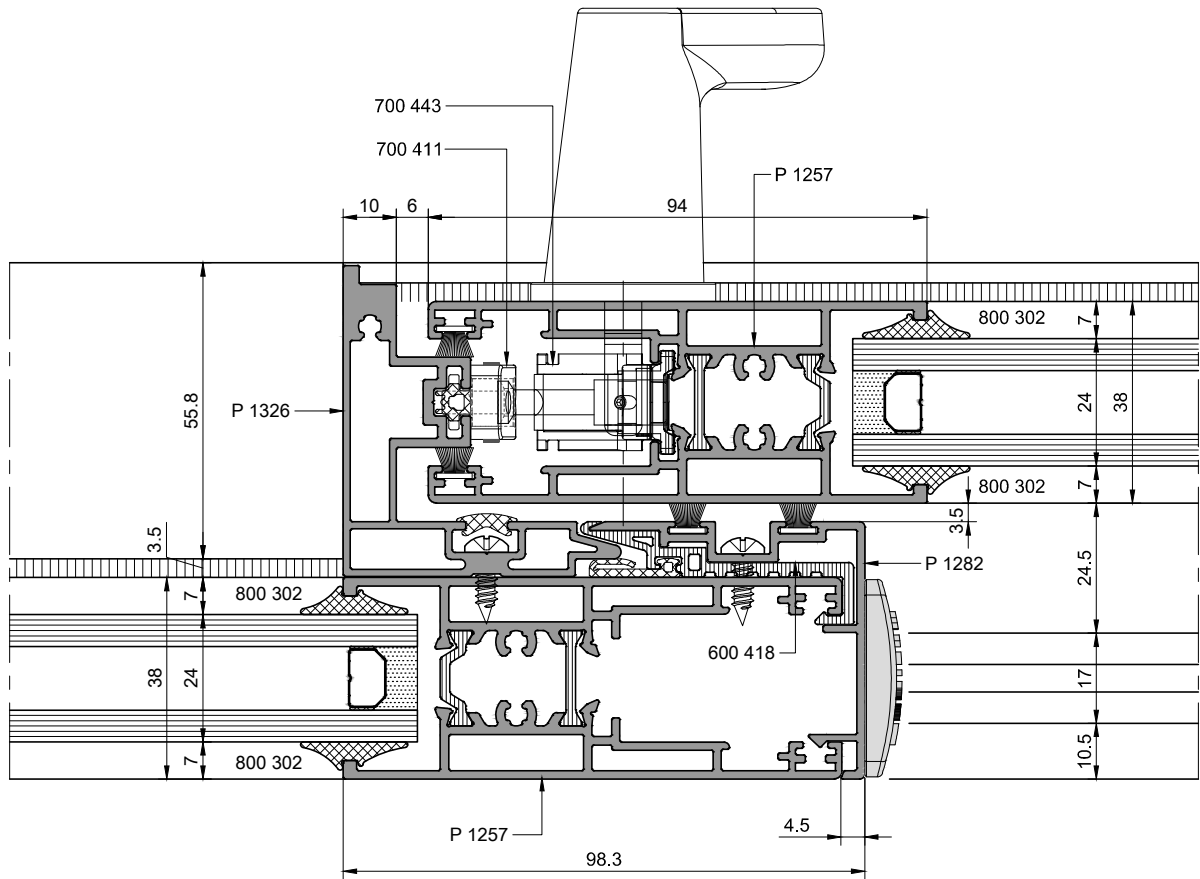

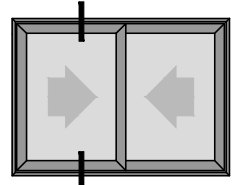
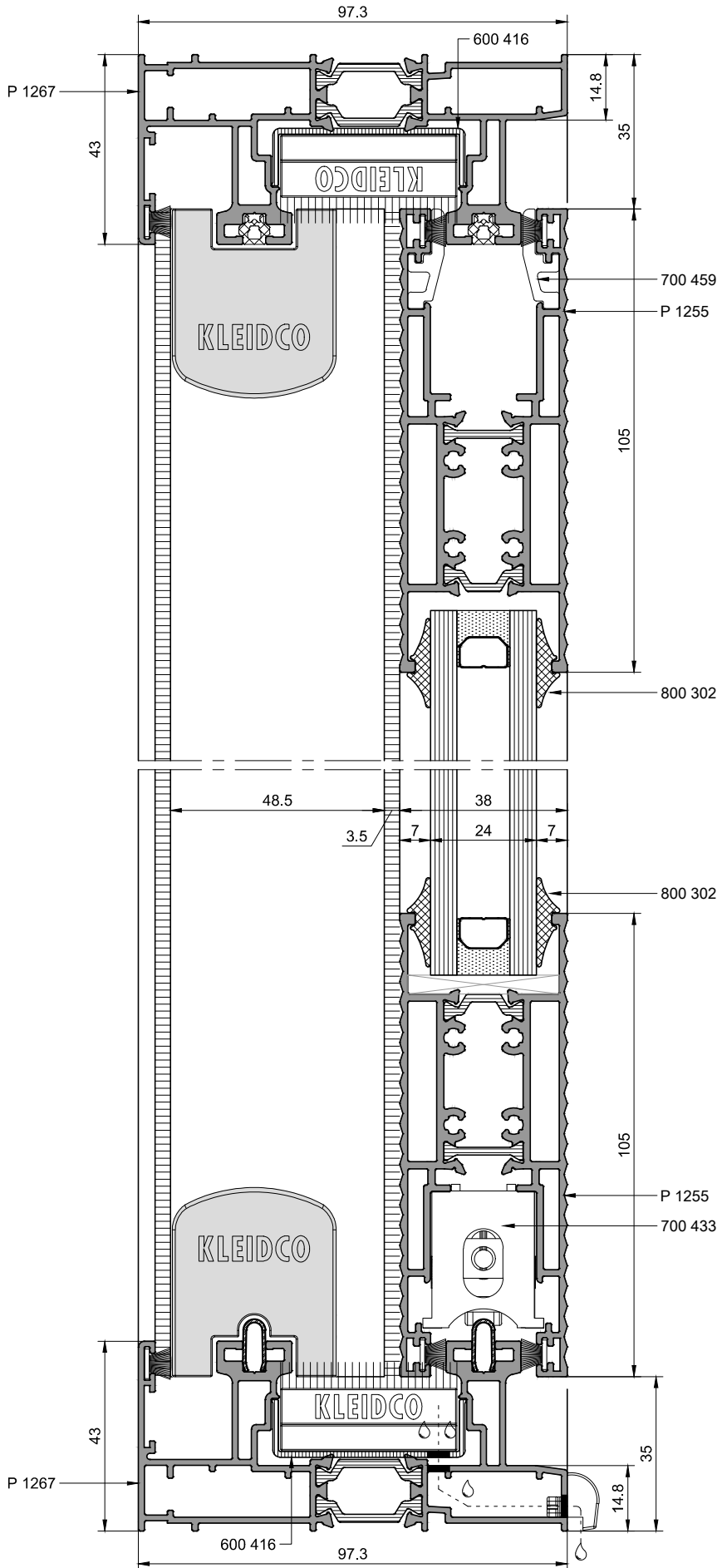

dış görünüş-external view

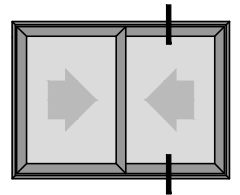
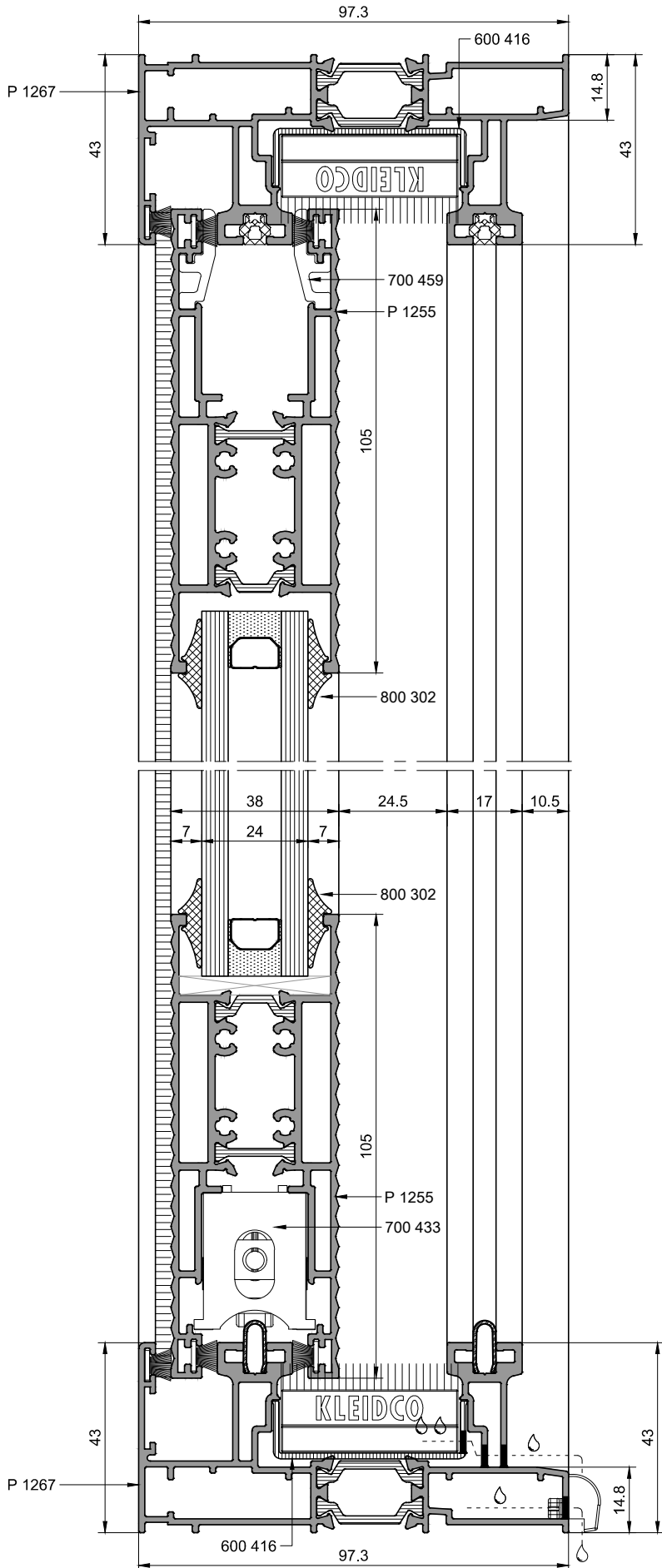

dış görünüş-external view

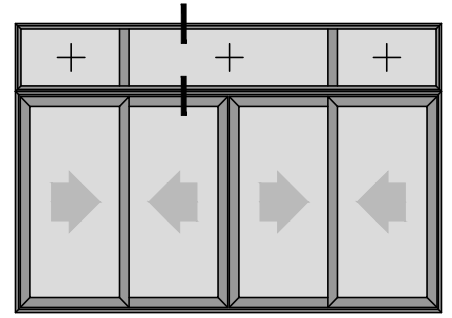
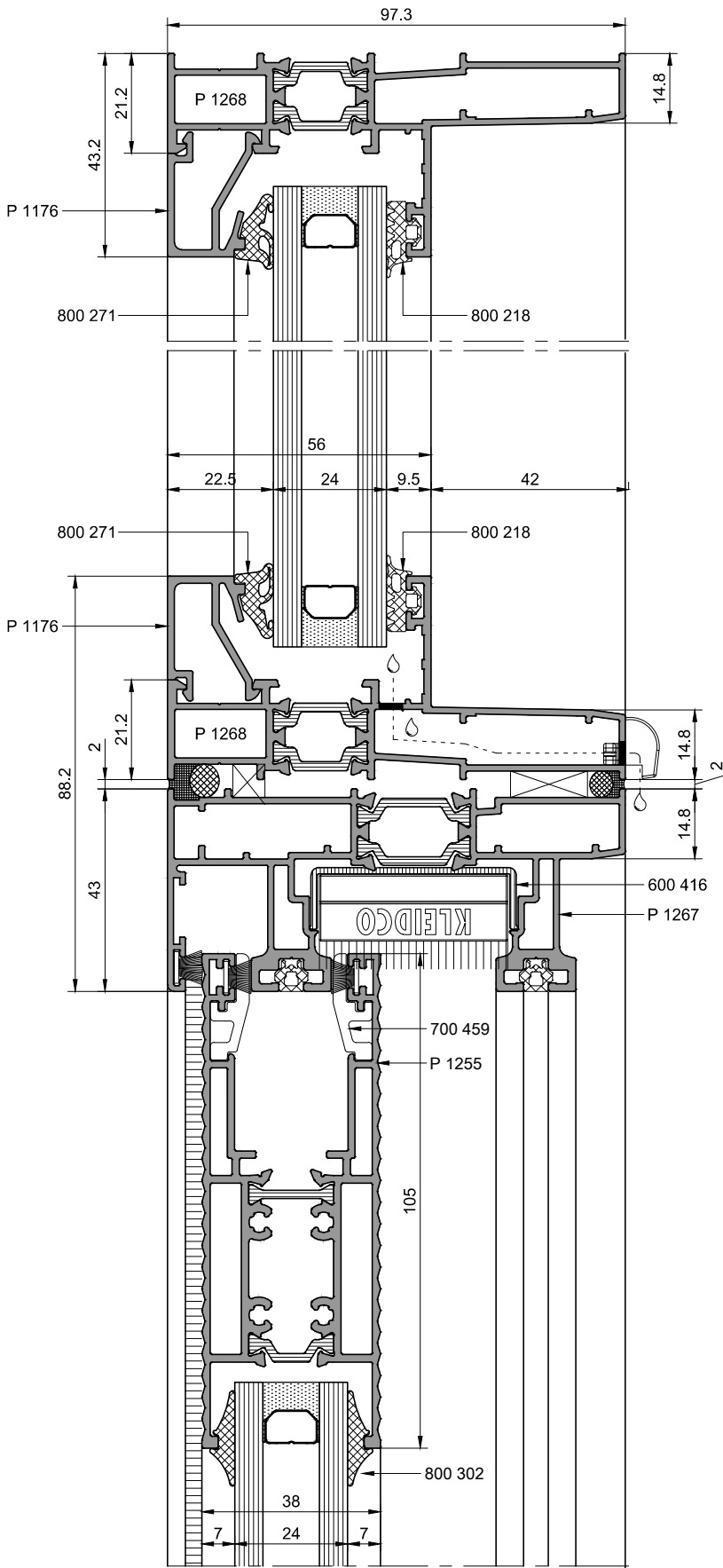

dış görünüş-external view

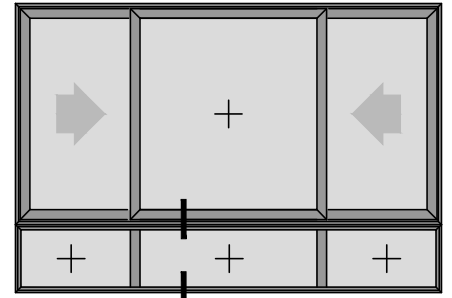
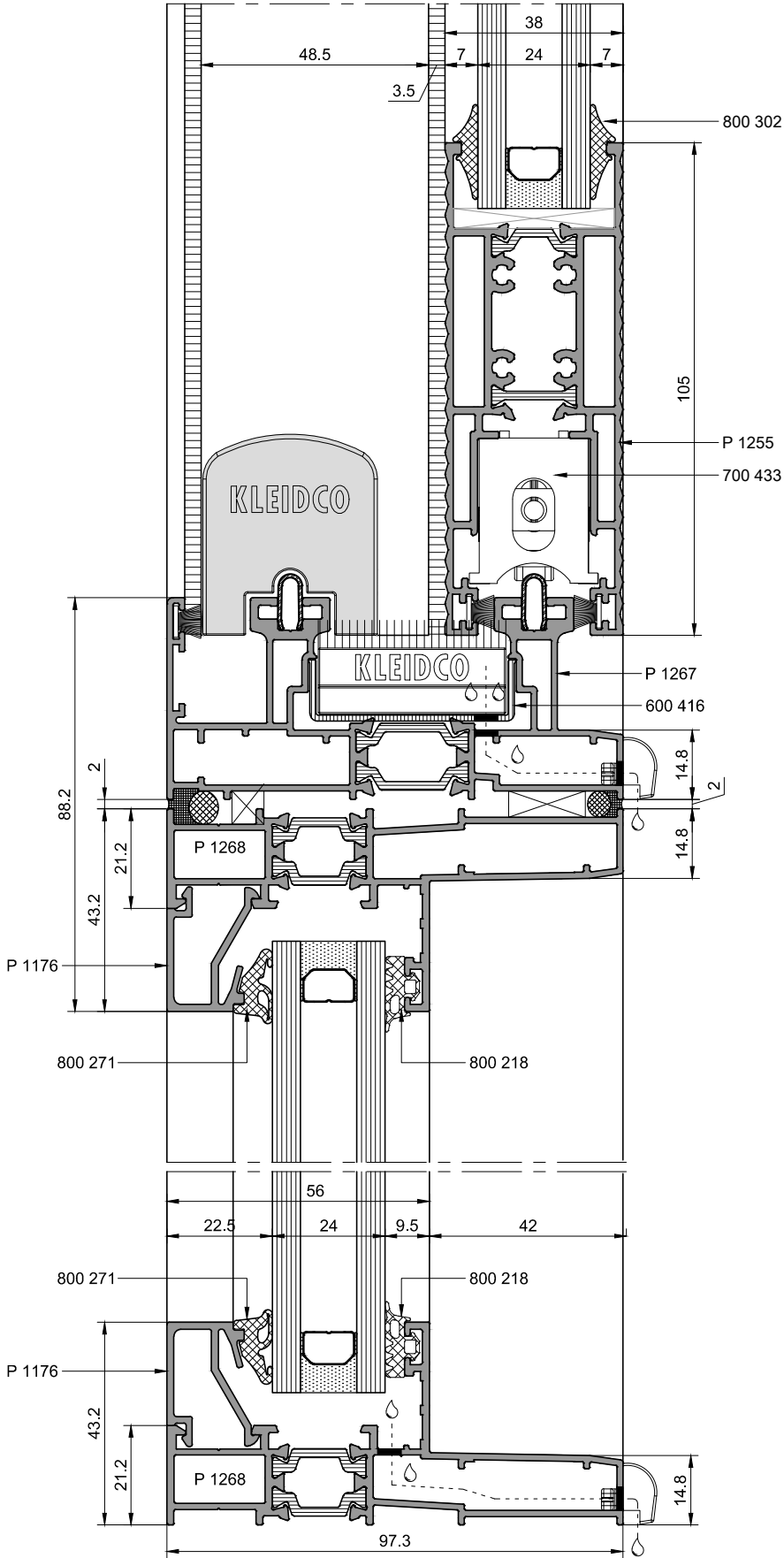

dış görünüş-external view

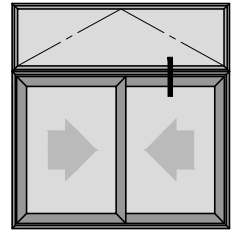

dış görünüş-external view

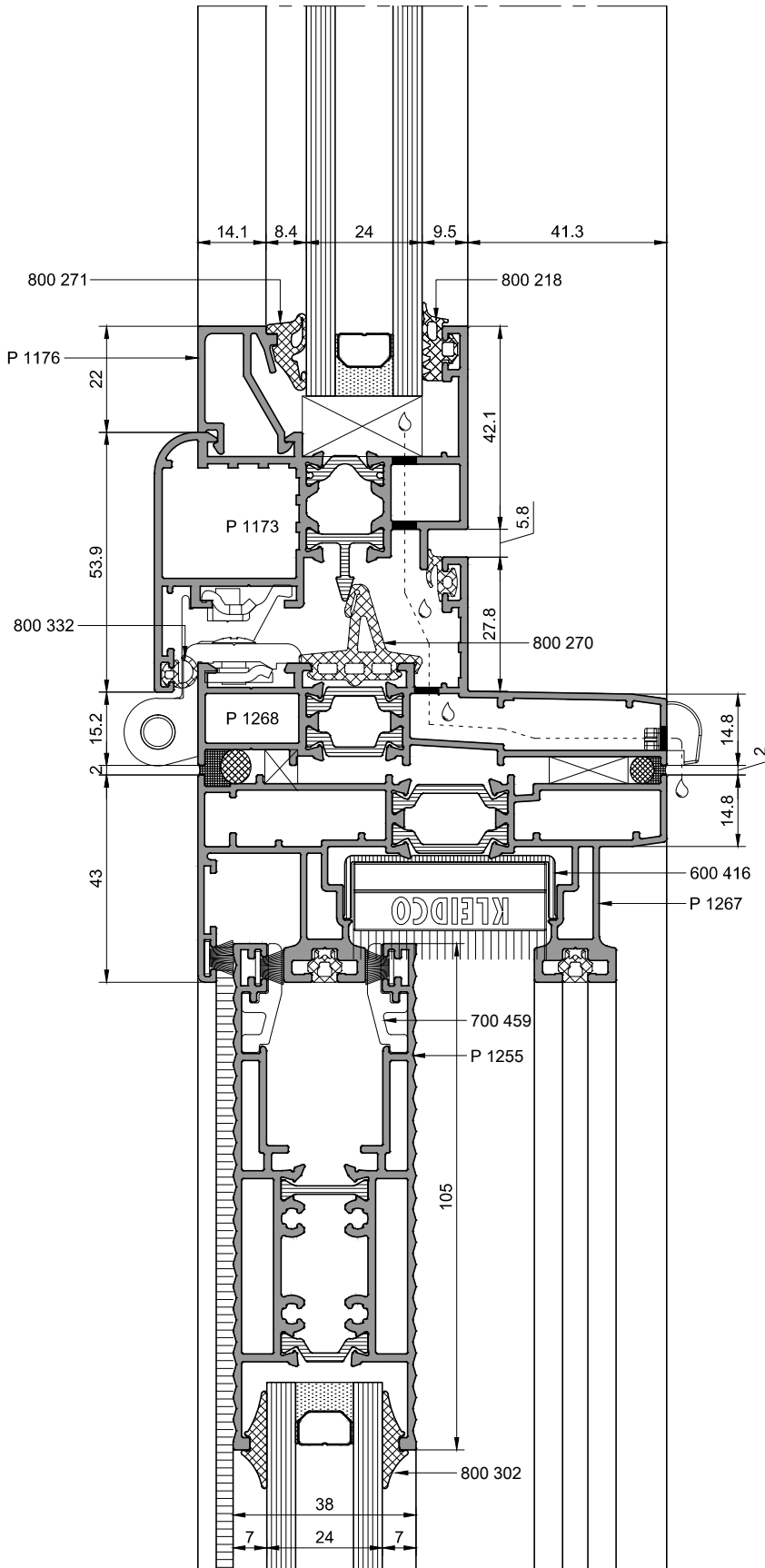

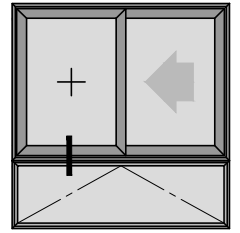

dış görünüş-external view

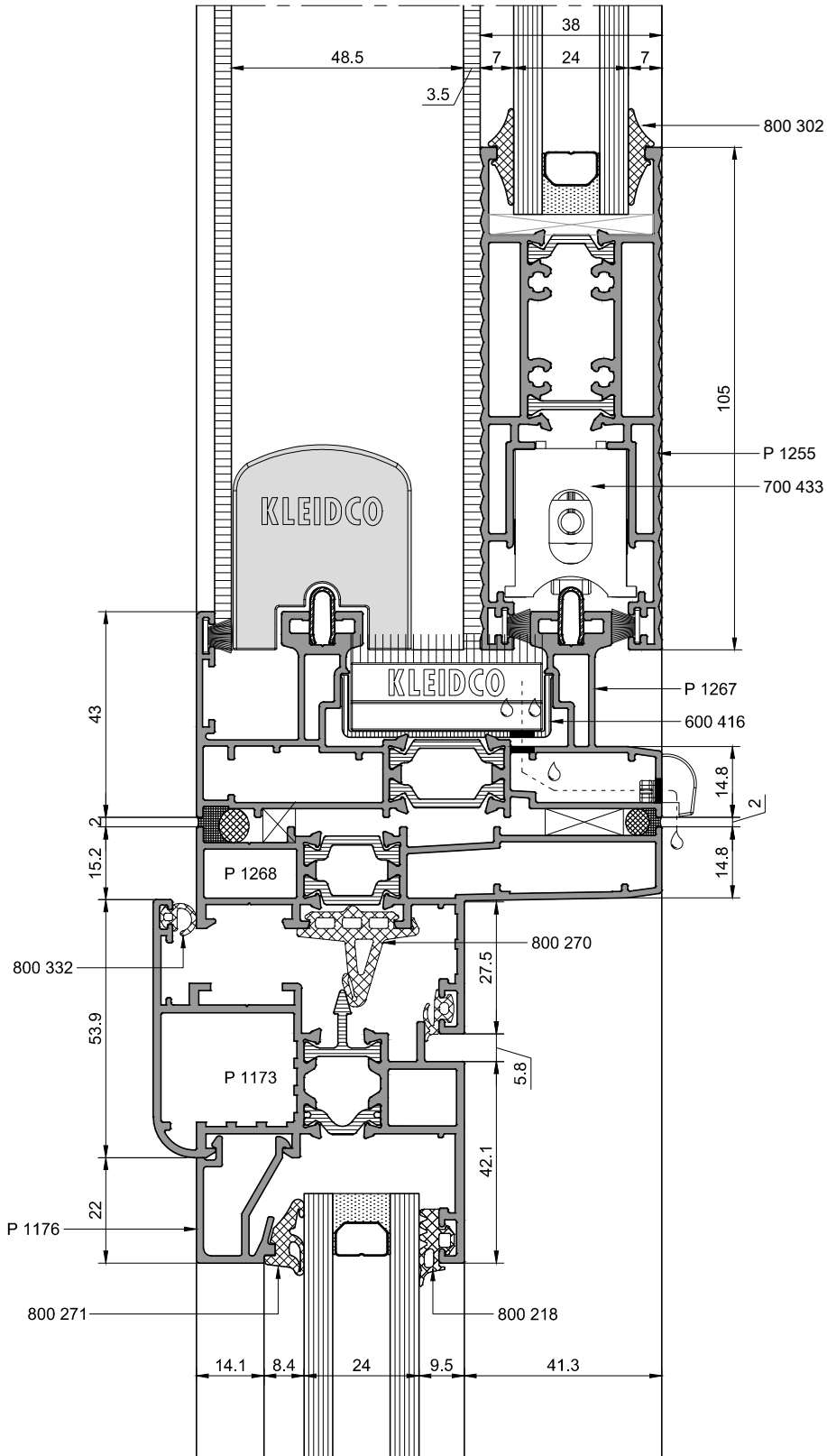

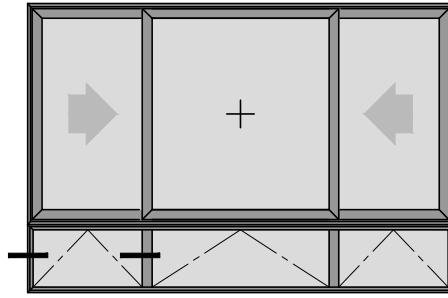

dış görünüş-external view

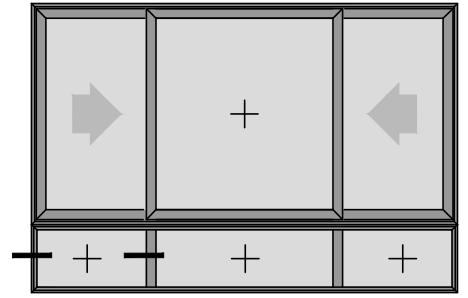

dış görünüş-external view

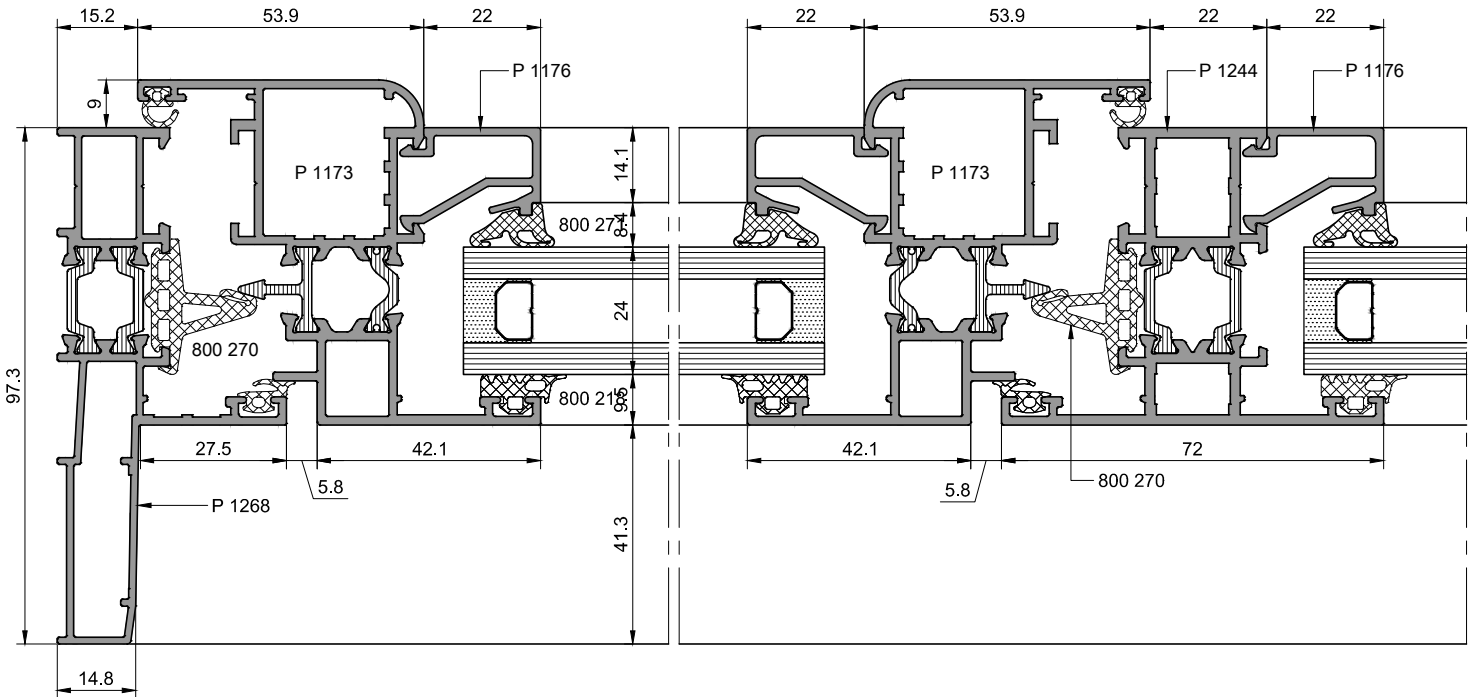
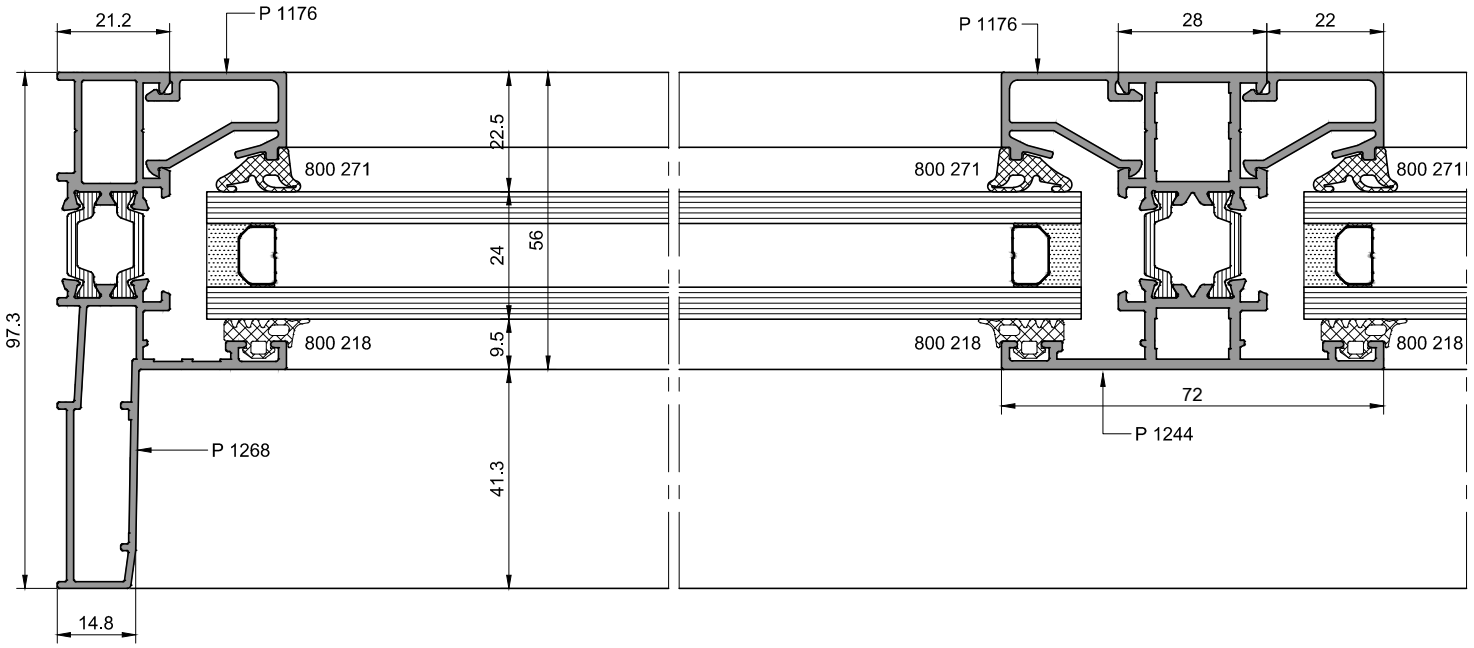

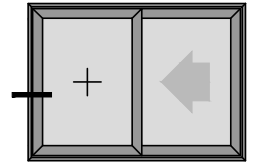

dış görünüş-external view

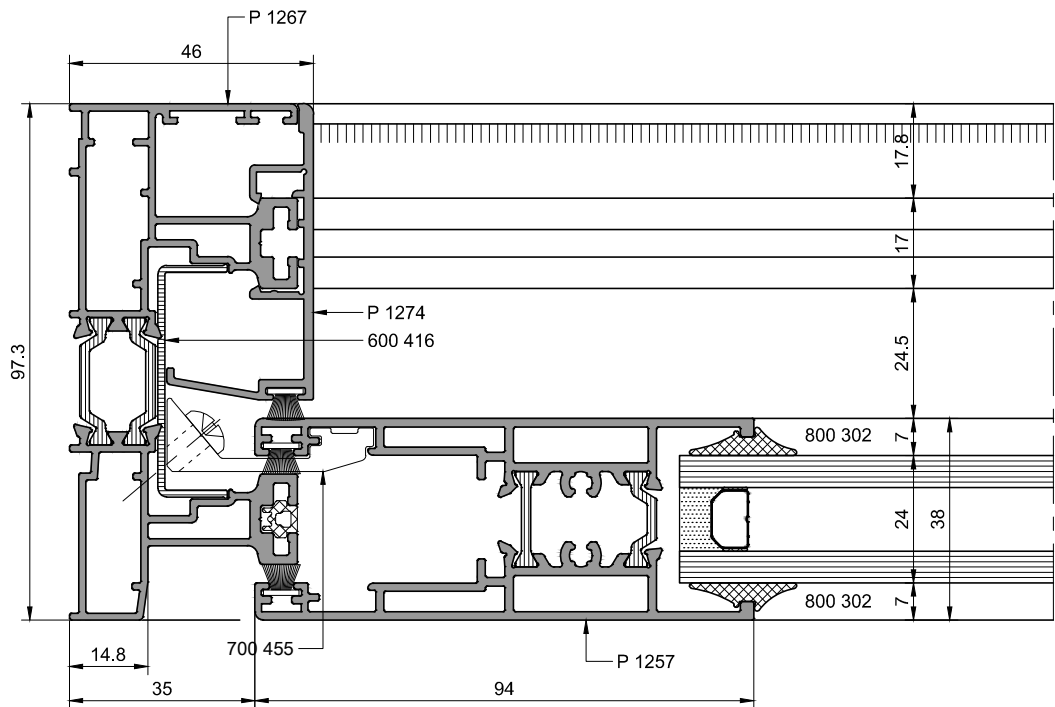

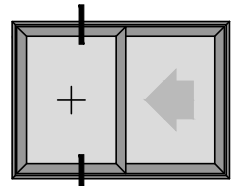
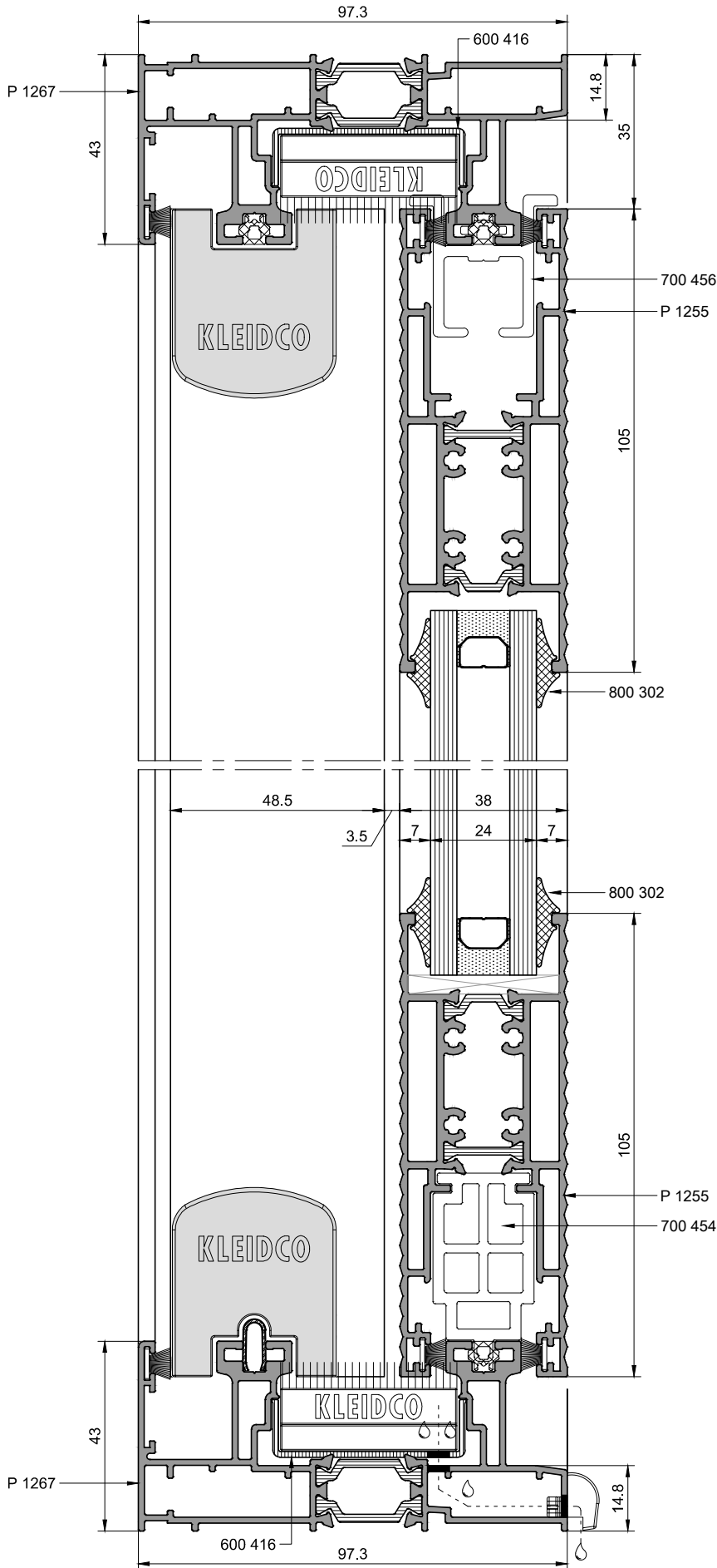

dış görünüş-external view

NOVA
BASİT SÜRME KAPI ve PENCERE SİSTEMİ
SIMPLE SLIDE DOOR and WINDOW SYSTEM

ÇİFT RAYLI SİNEKLİKLİ KASA
SİSTEM DETAYLARI
DOUBLE TRACK RAIL with FLY SCREEN RAIL
PRINCIPAL SECTION

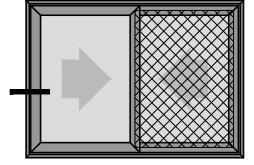

dış görünüş-external view

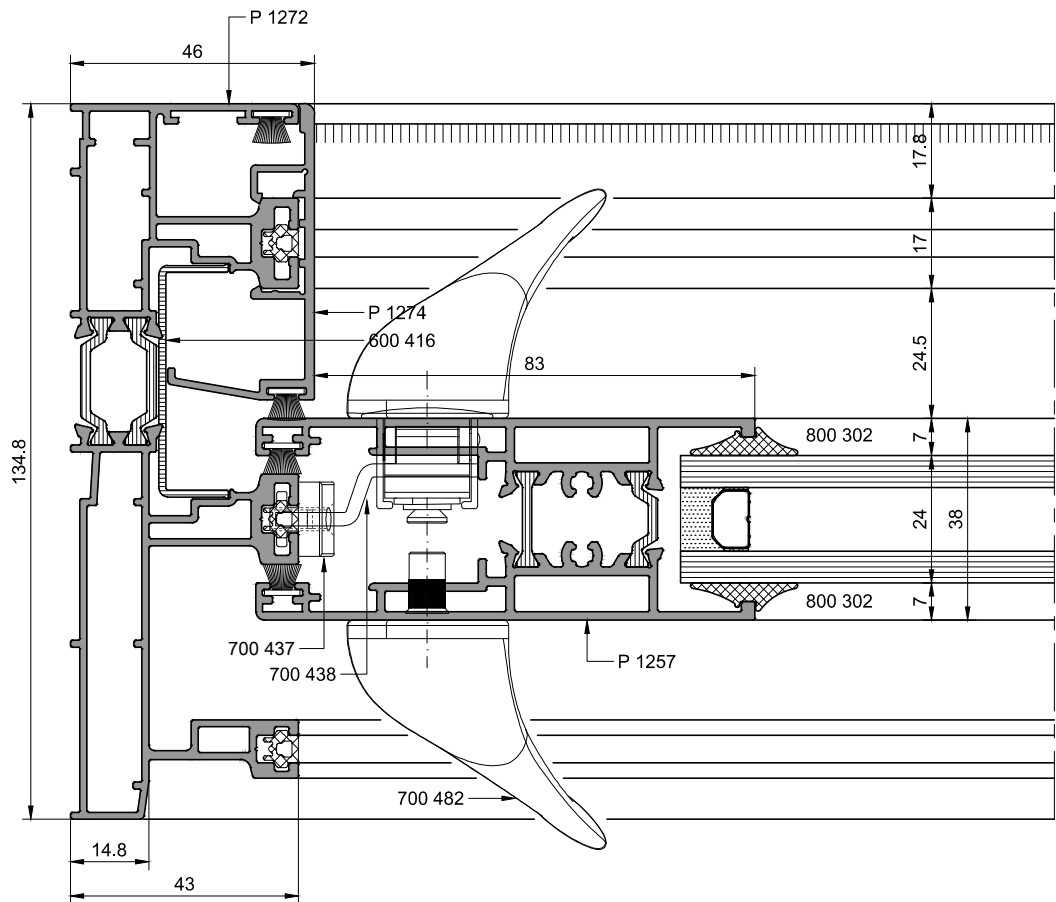

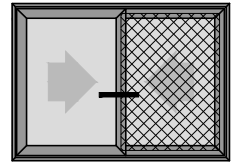

dış görünüş - external view

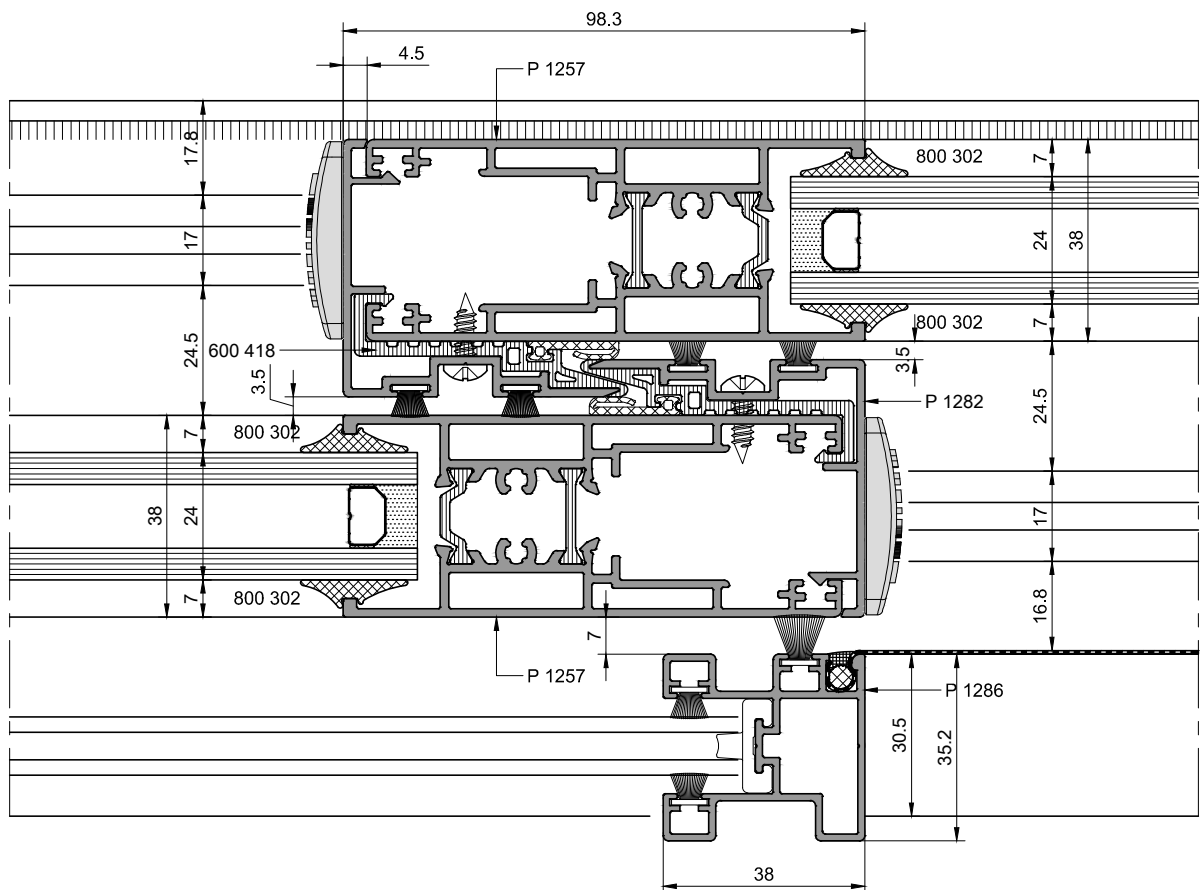

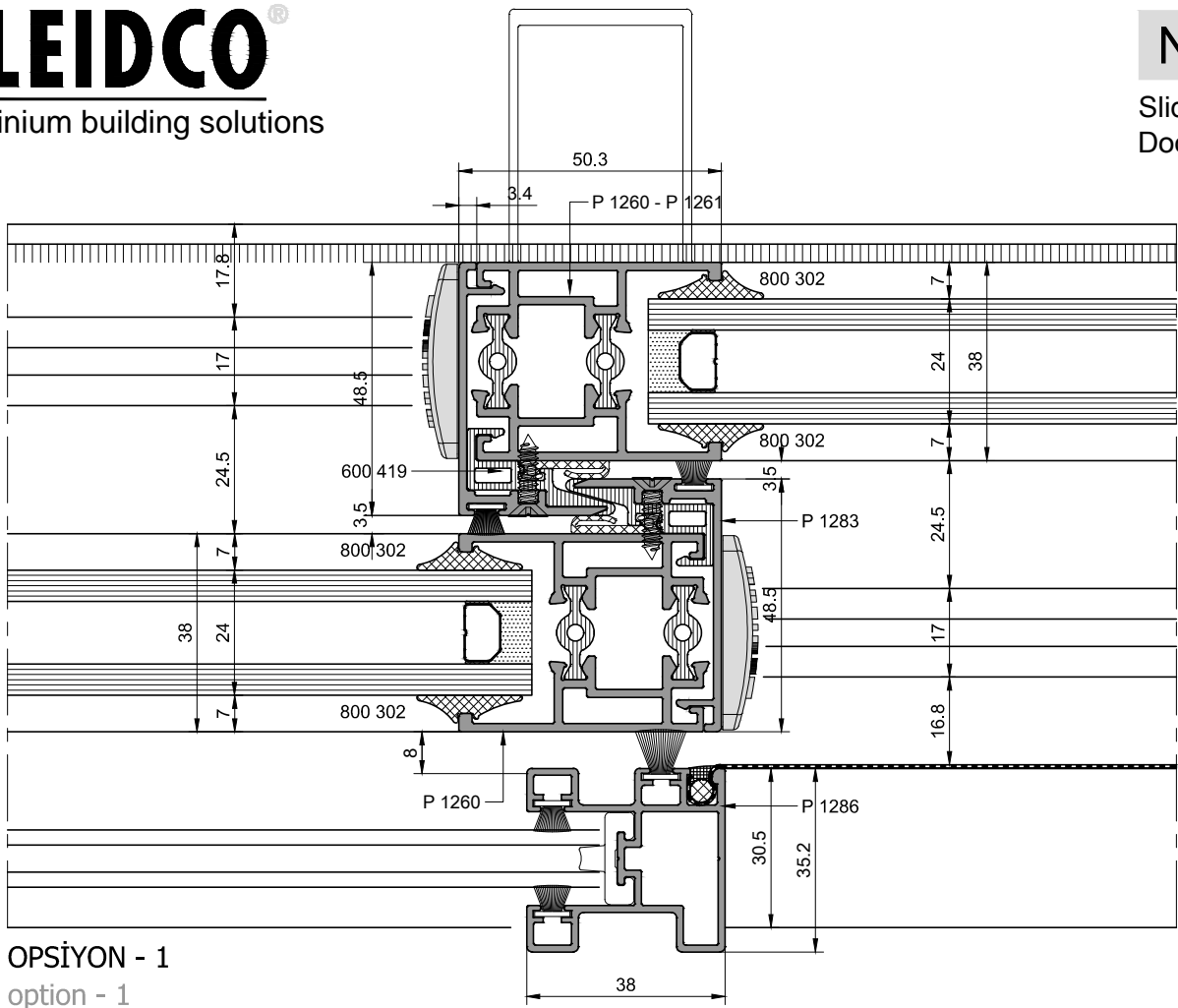

OPSIYON - 1
option - 1

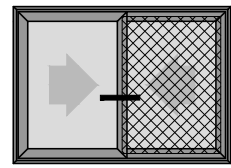

dış görünüş-external view

OPSIYON - 2
option - 2

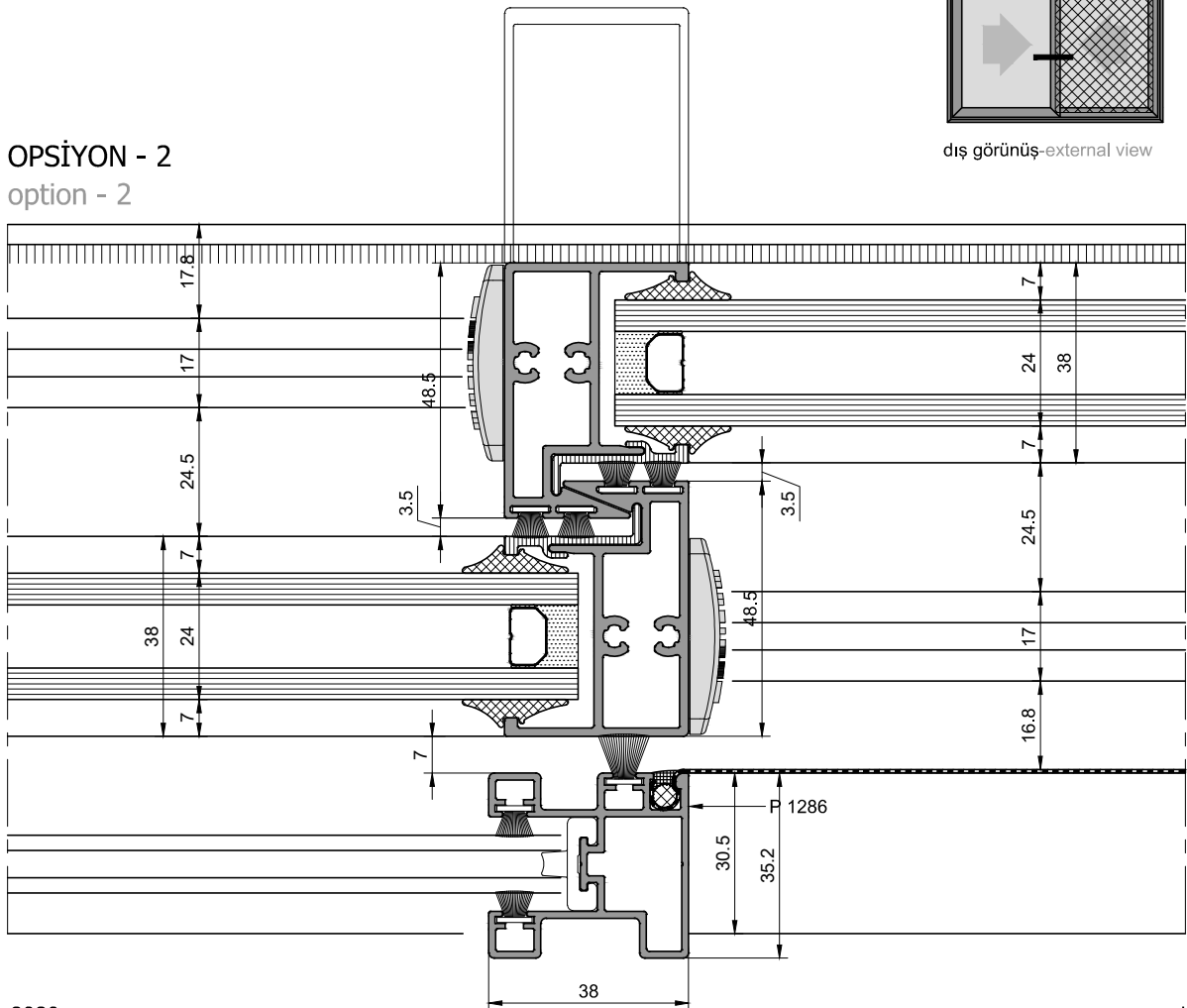

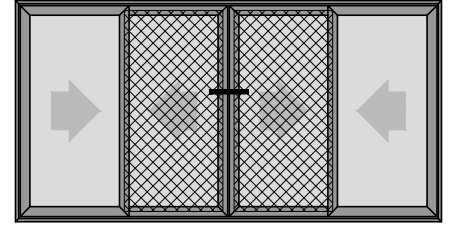

dış görünüş-external view

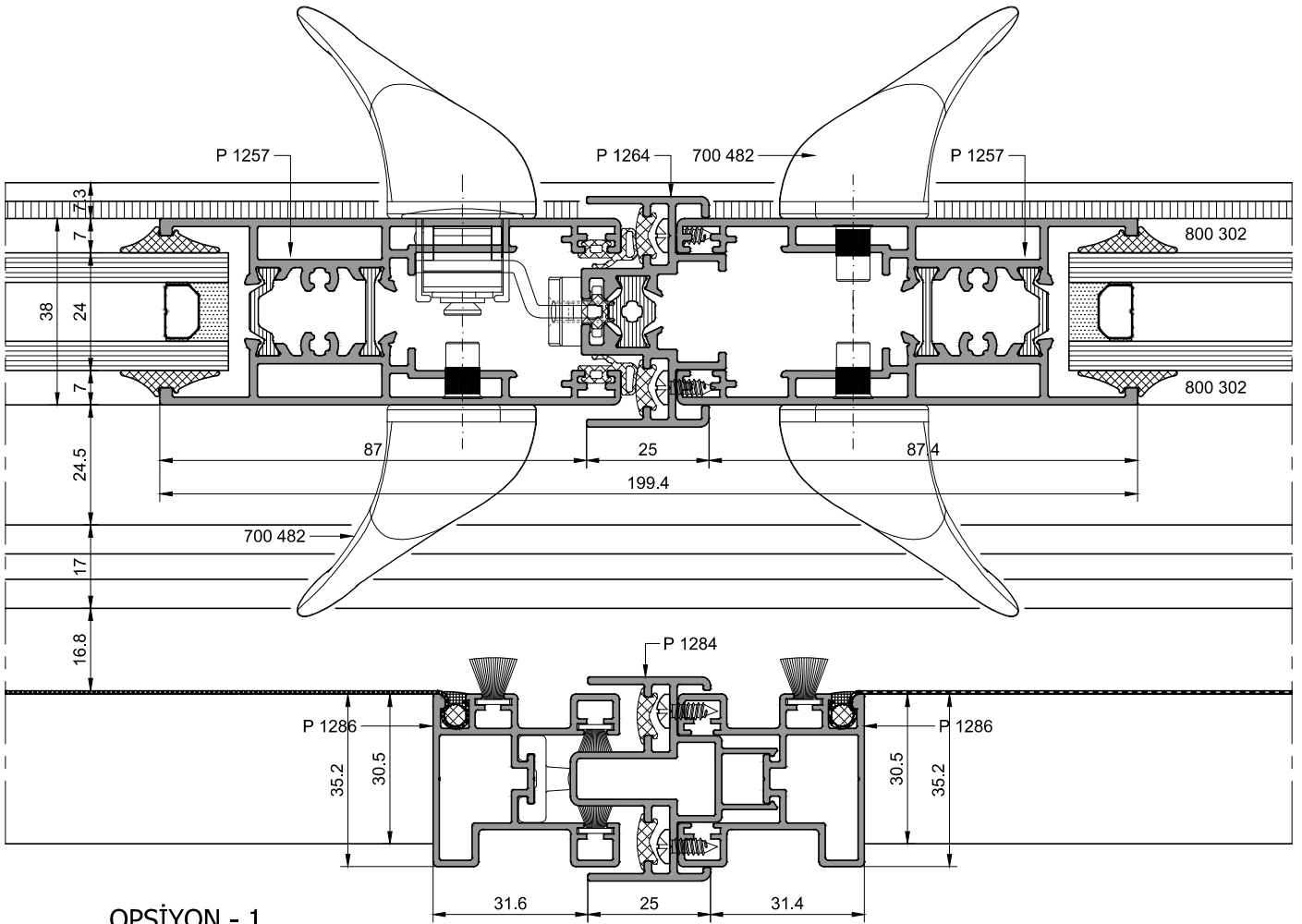

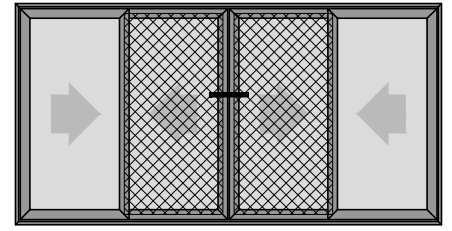

dış görünüş-external view

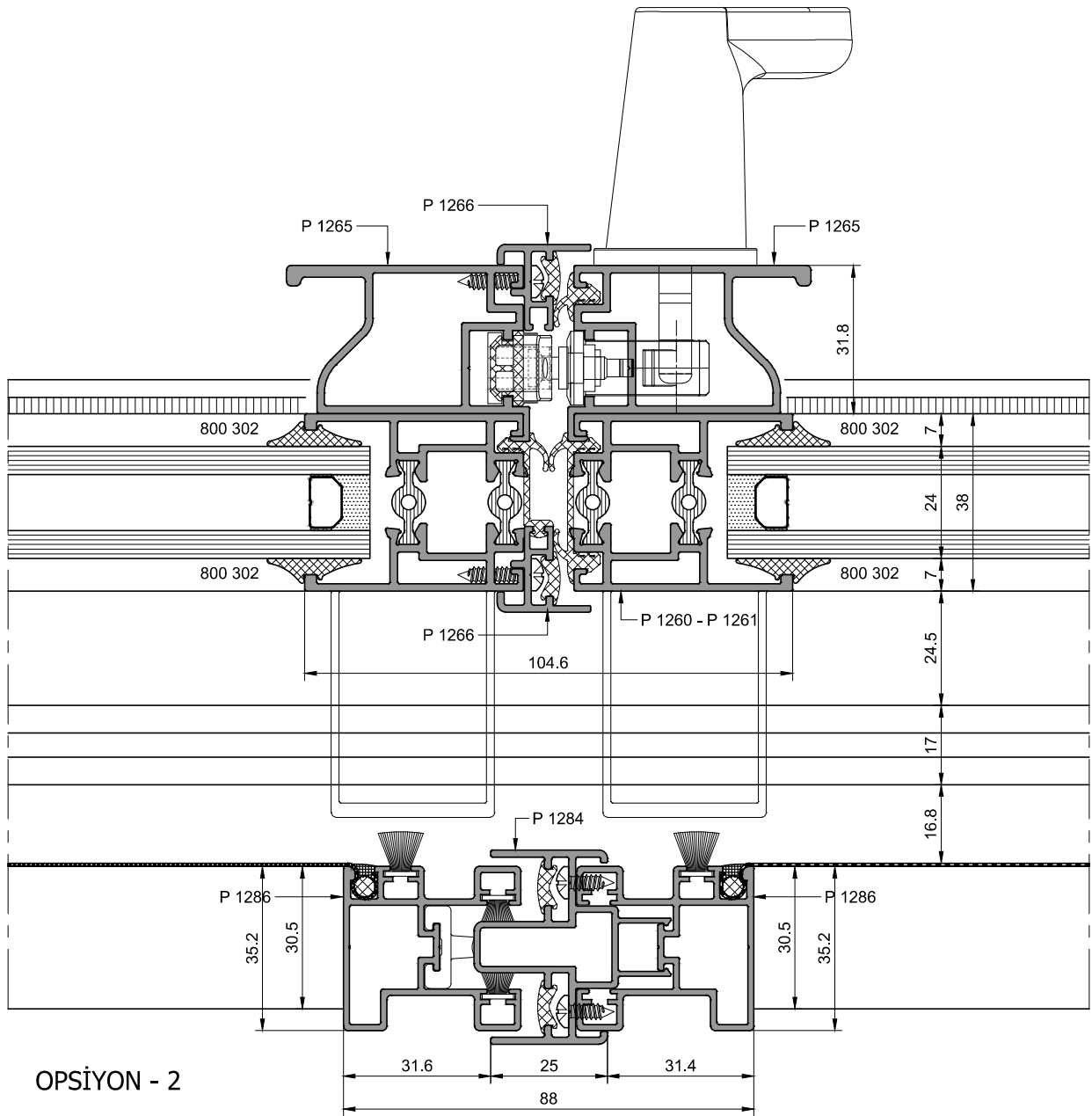

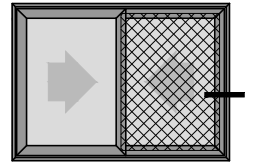

dış görünüş - external view

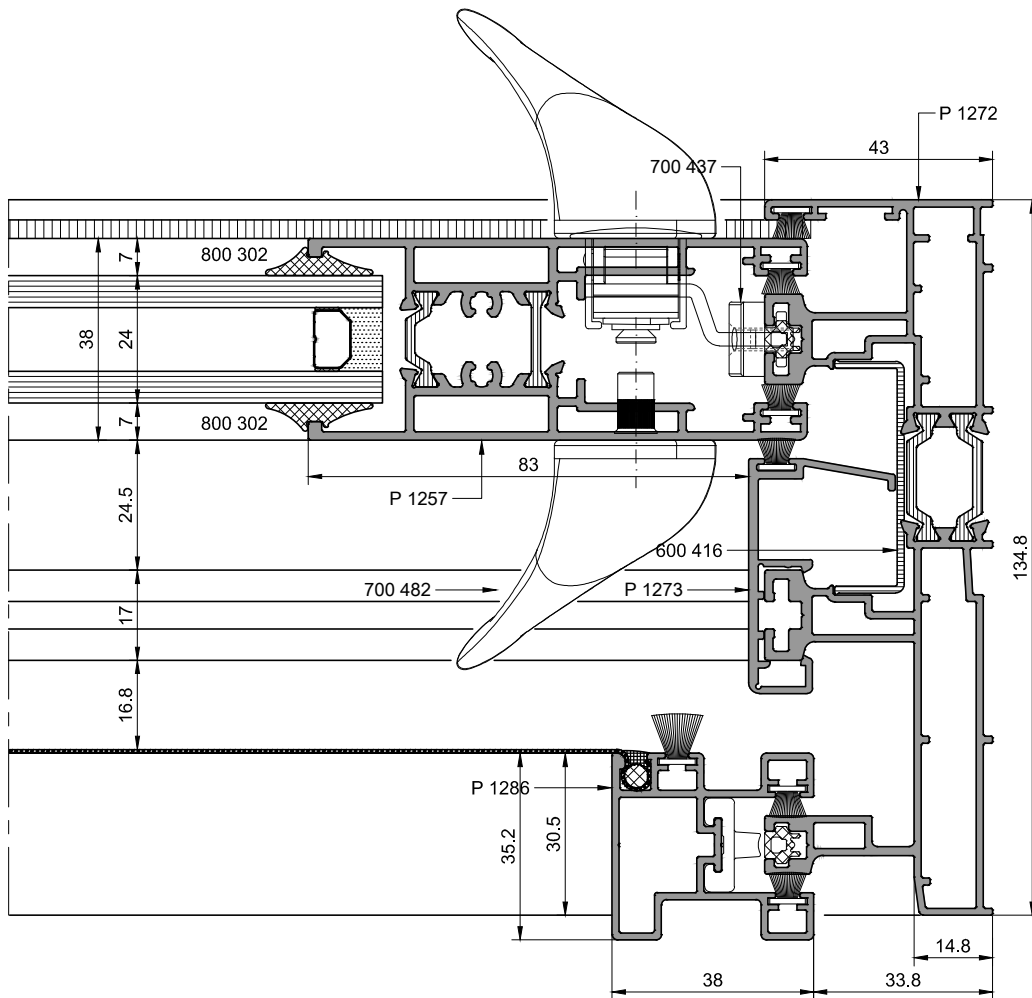

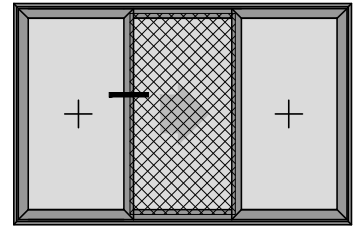

dış görünüş-external view

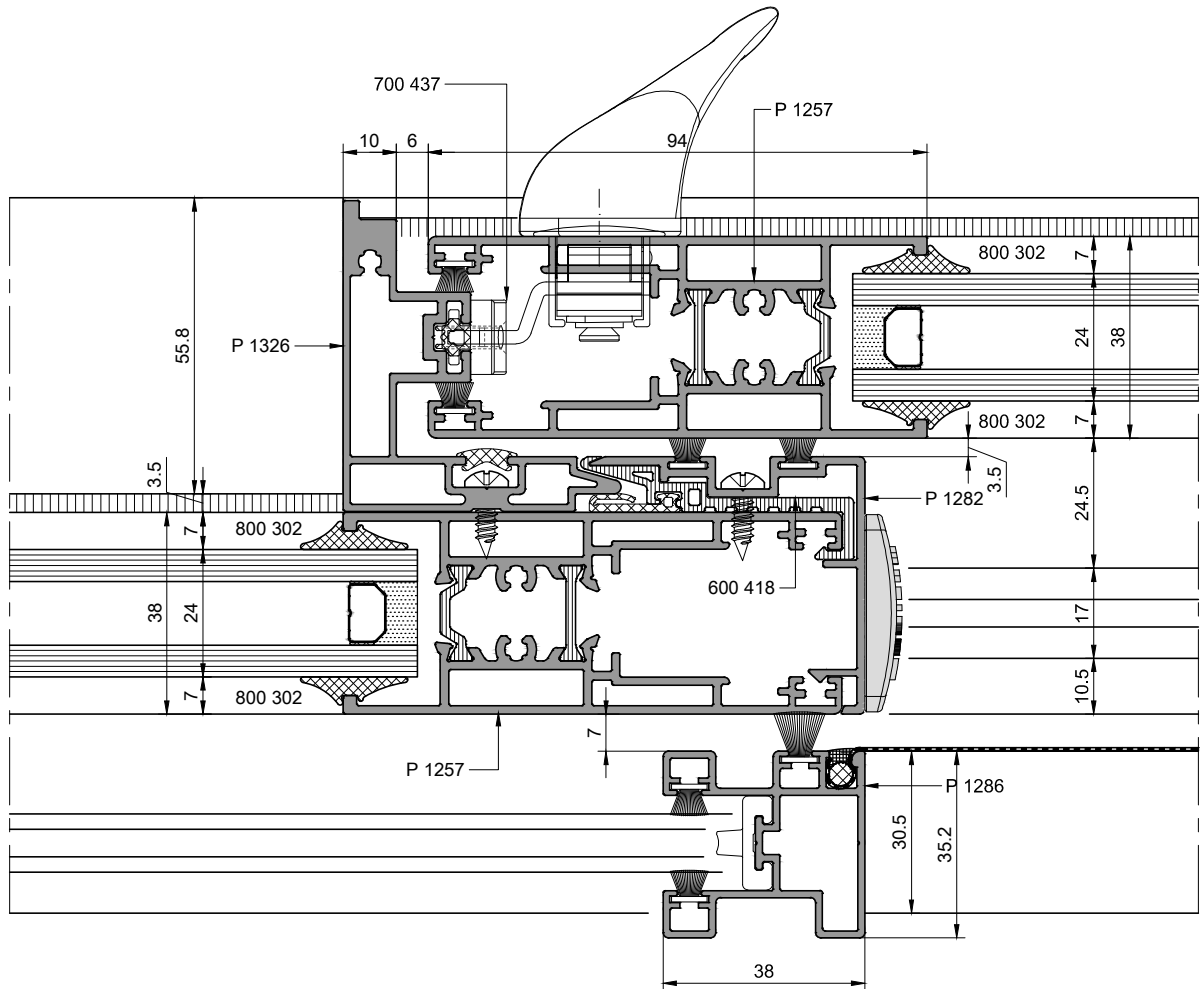

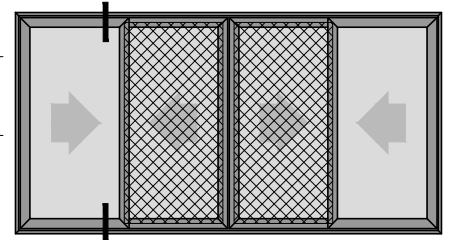
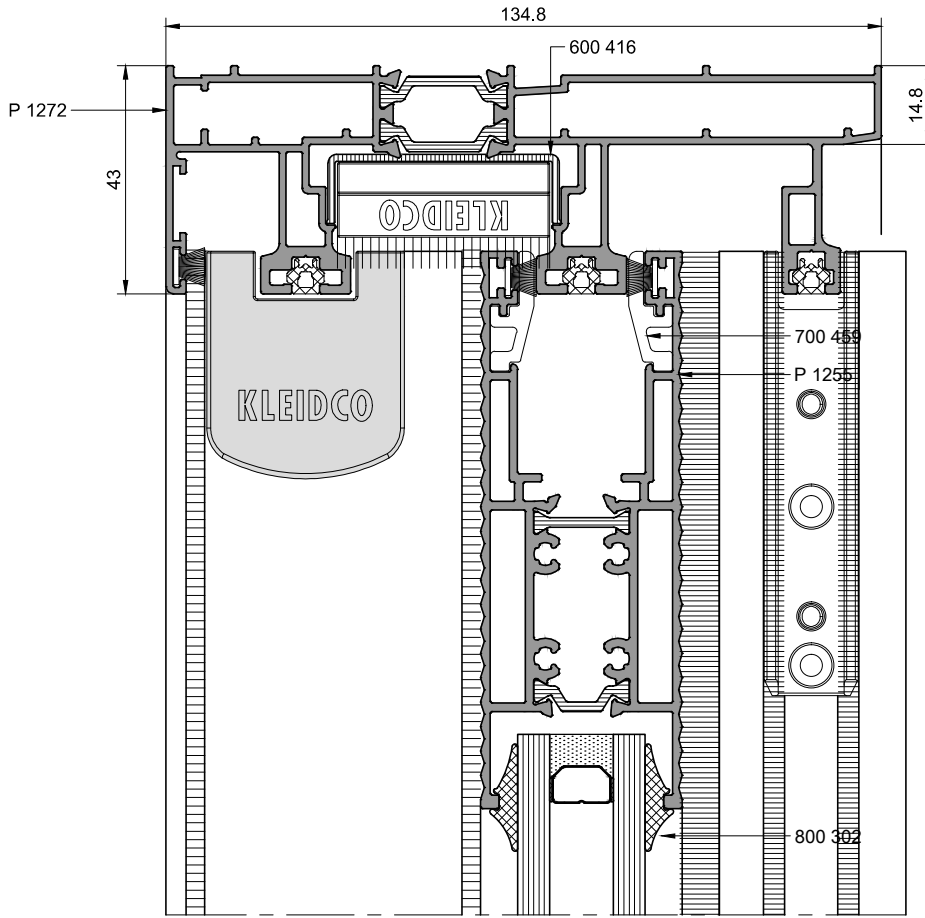

dış görünüş-external view

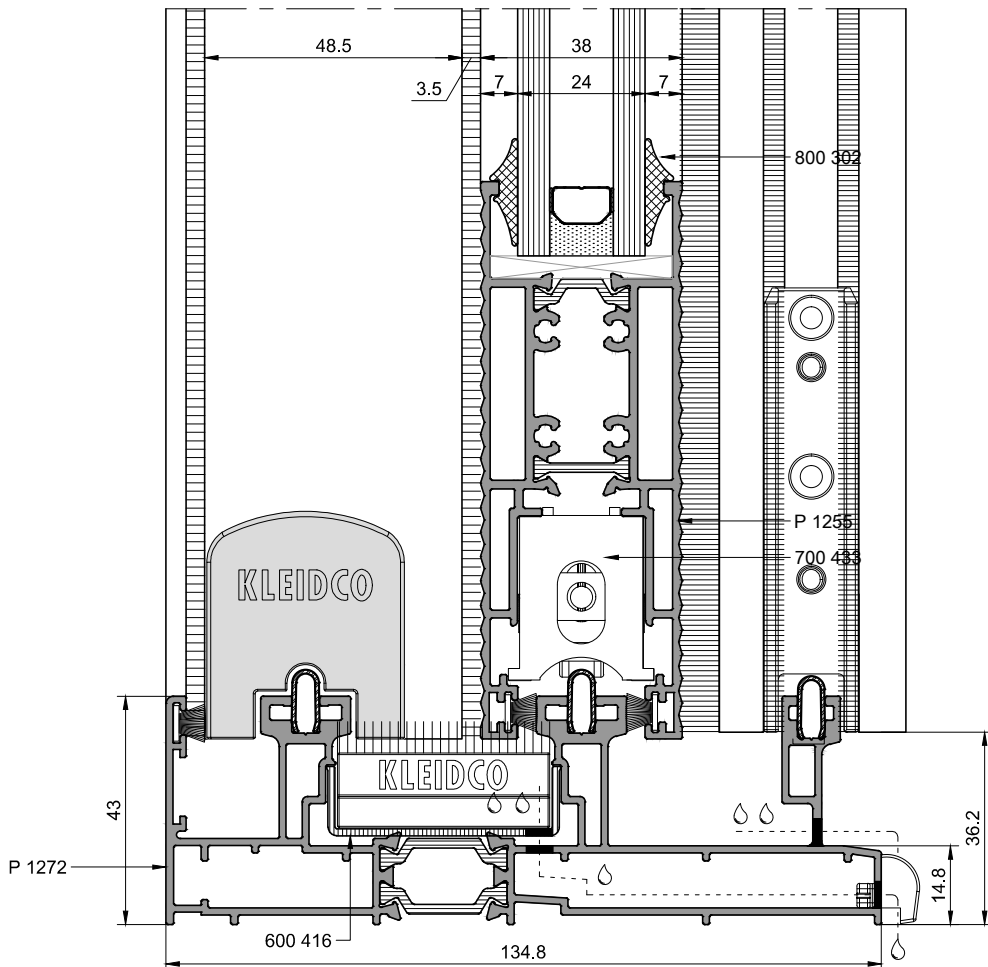

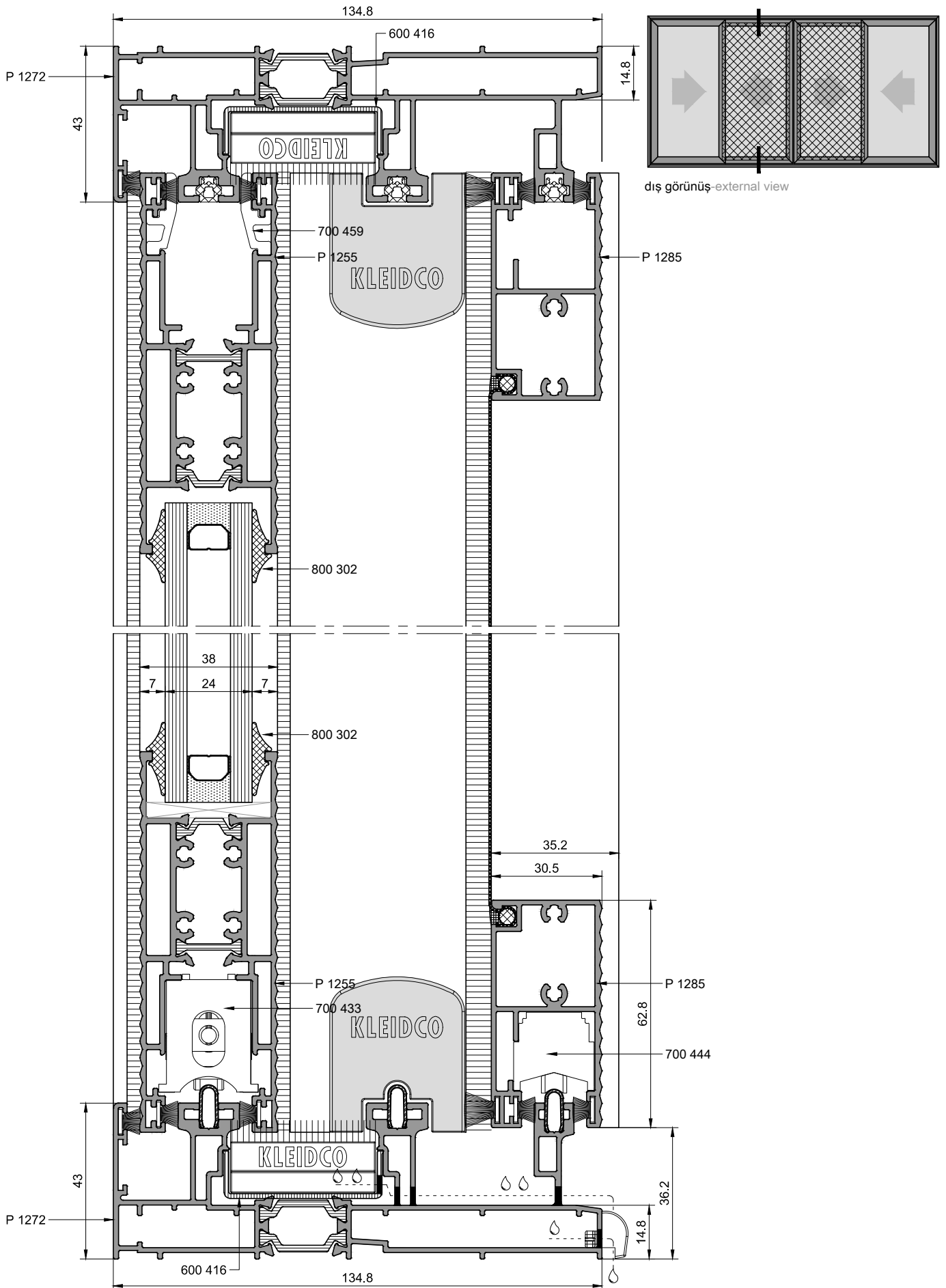

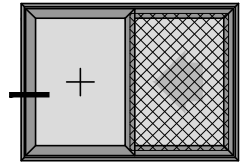

dış görünüş - external view

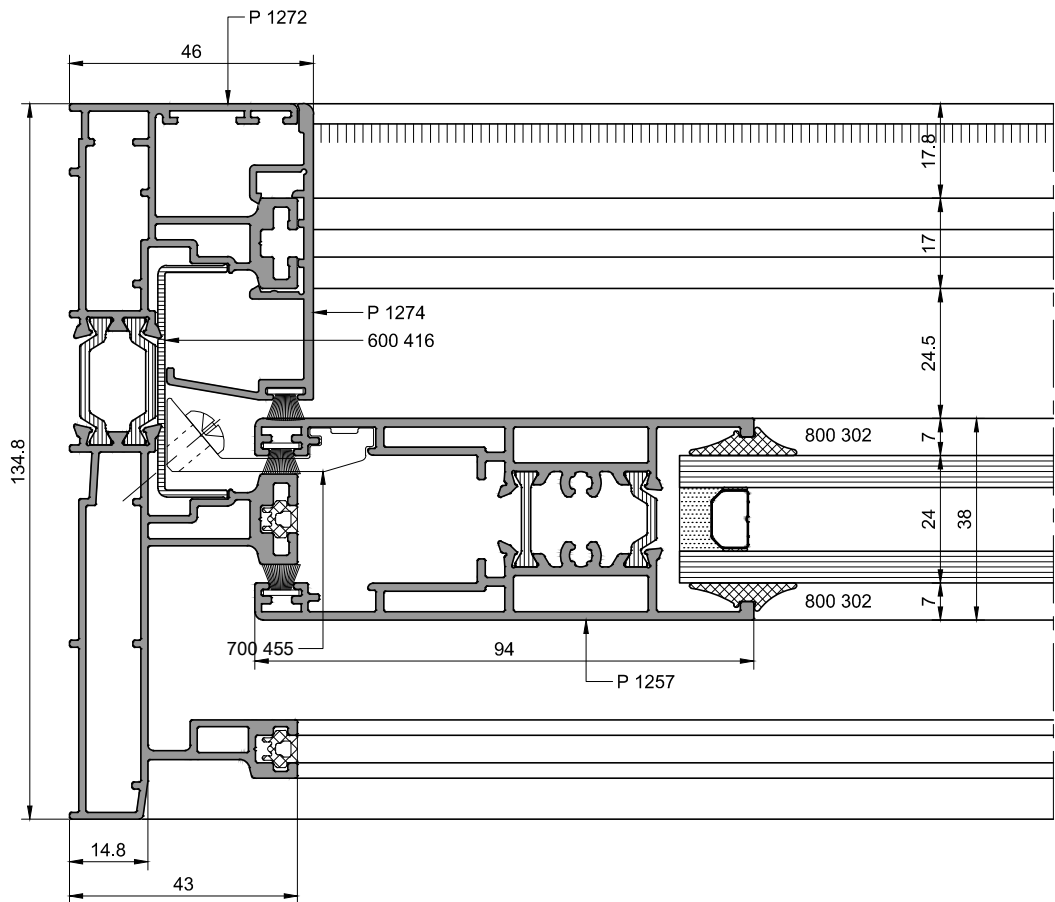

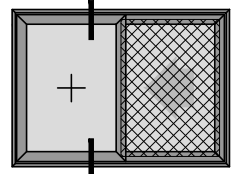

dış görünüş - external view

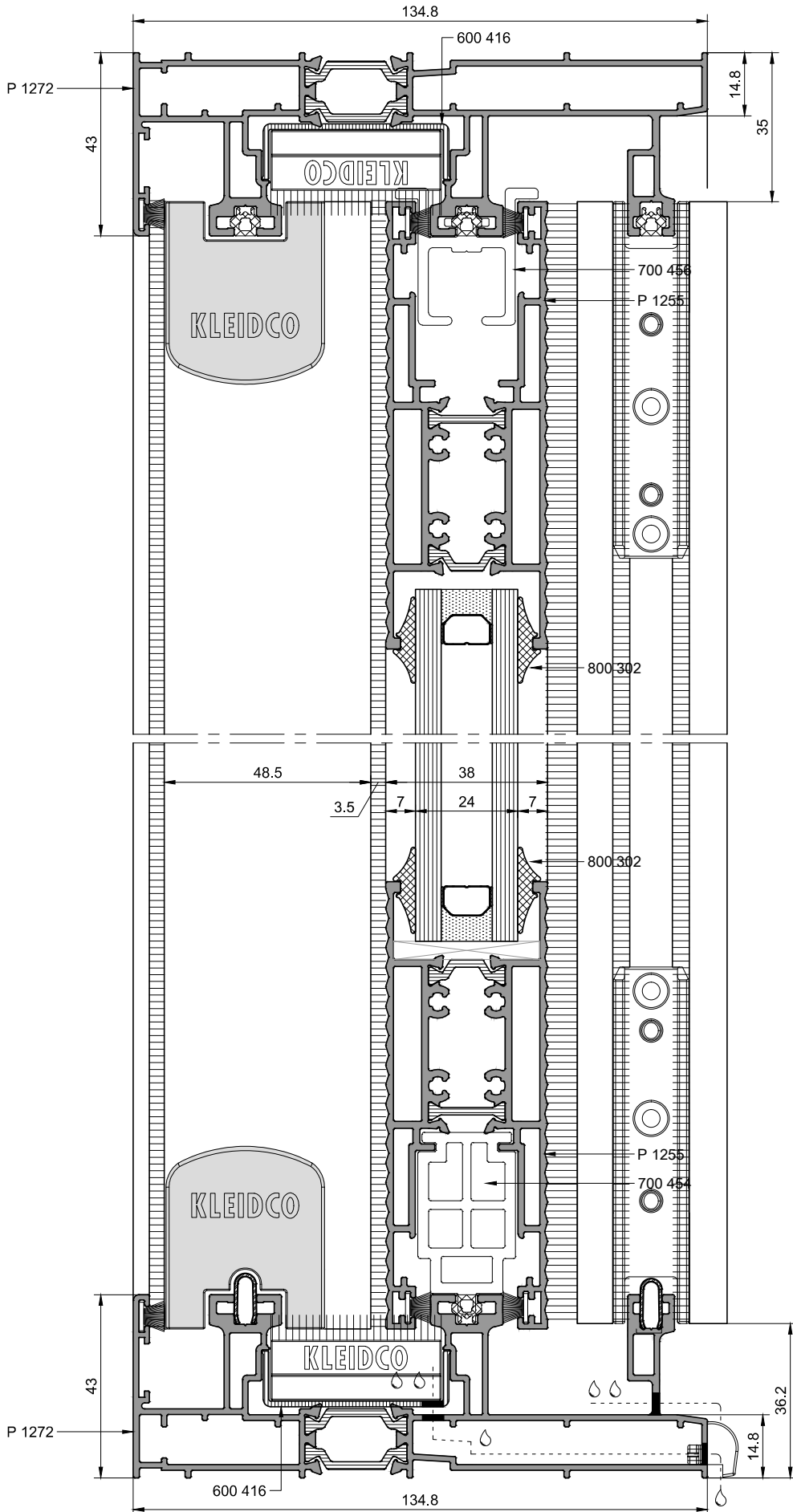

NOVA
BASİT SÜRME KAPI ve PENCERE SİSTEMİ
SIMPLE SLIDE DOOR and WINDOW SYSTEM

ÇİFT RAYLI KASA İLE KALDIR-SÜR
SİSTEM DETAYLARI
LIFT&SLIDE DOOR with DOUBLE TRACK RAIL
PRINCIPAL SECTION

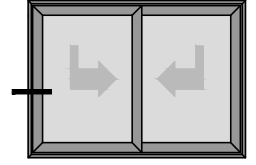

dış görünüş - external view

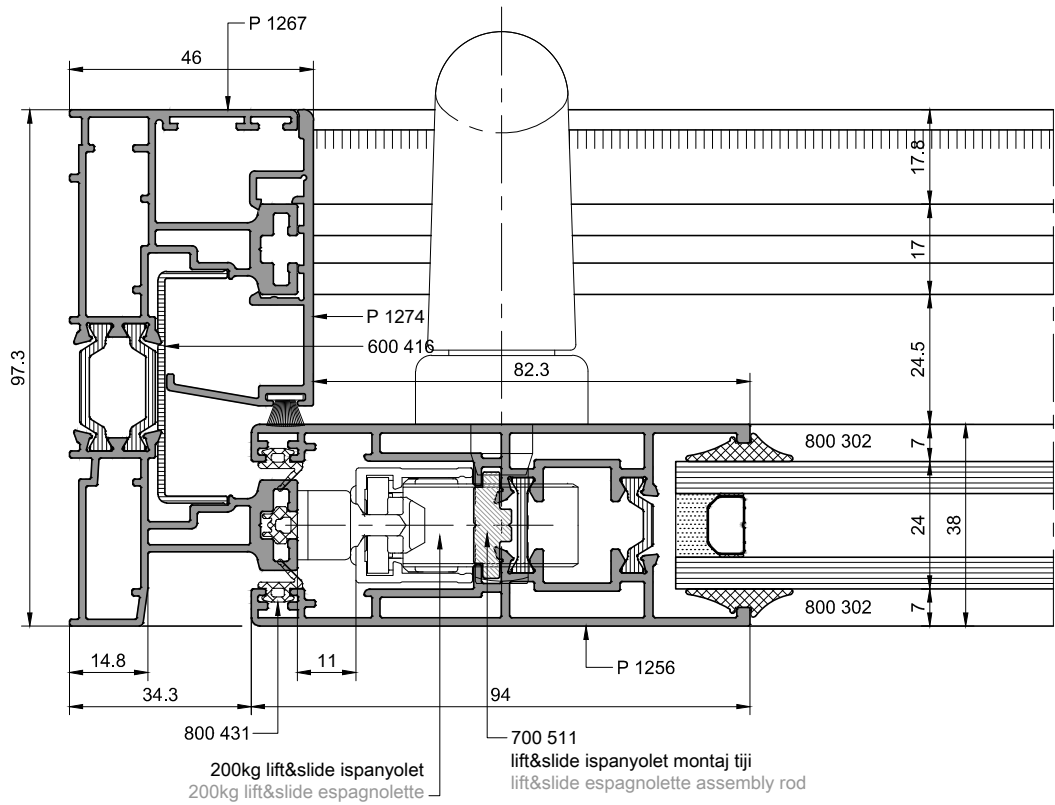

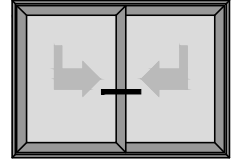

dış görünüş - external view

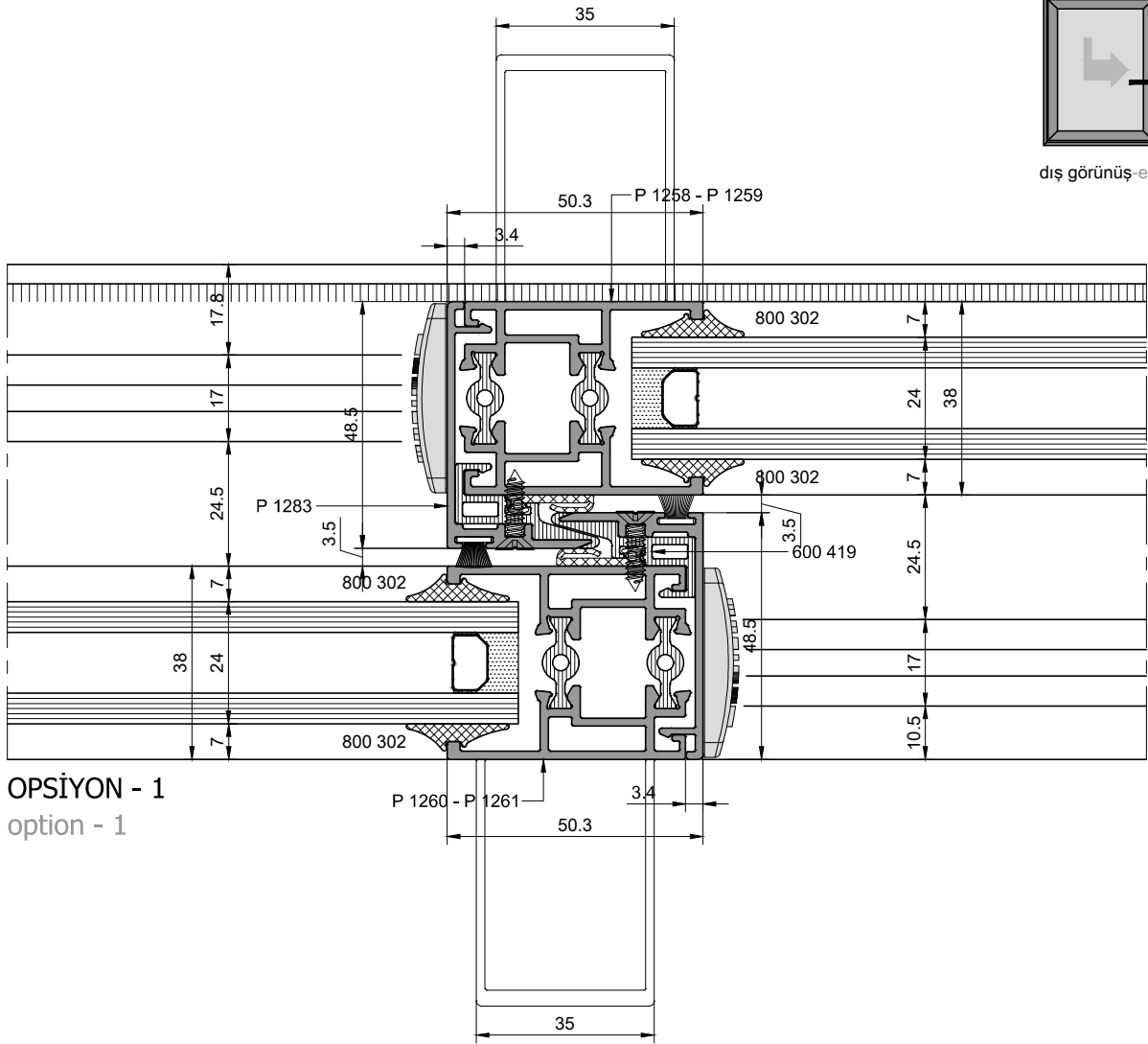

OPSIYON - 1
option - 1

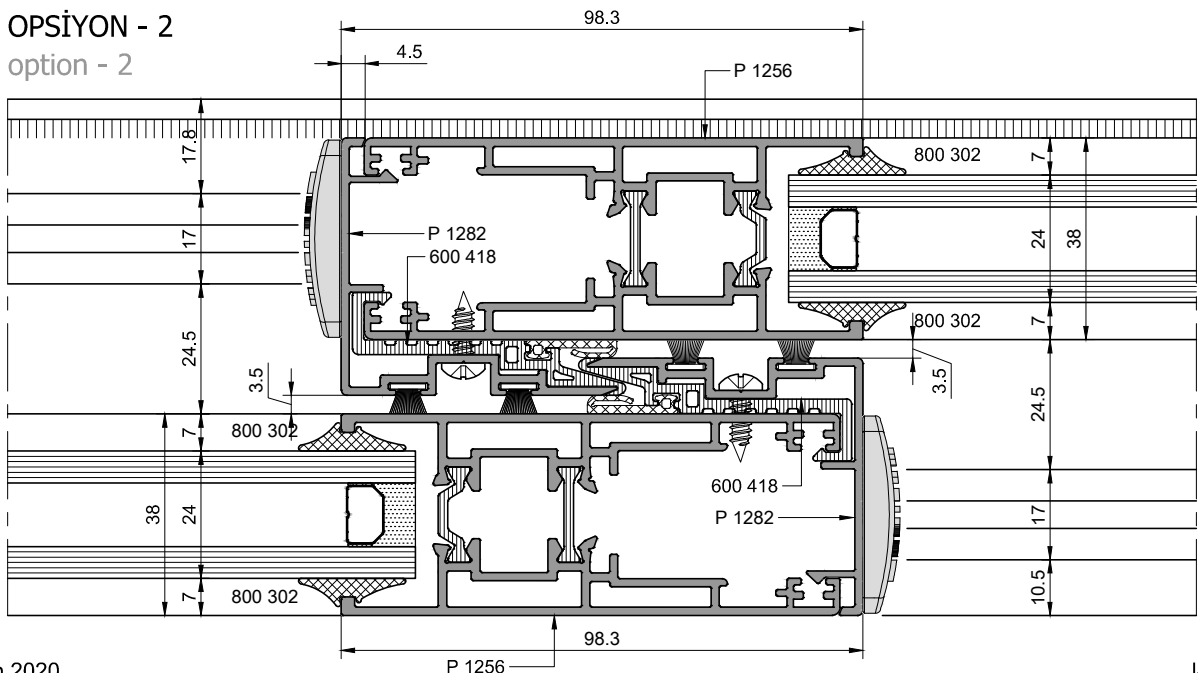

OPSIYON - 2
option - 2

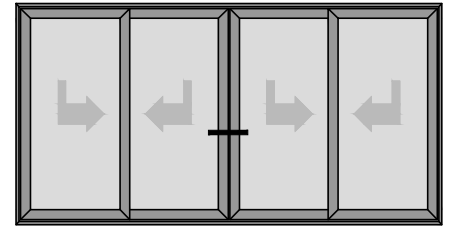

dış görünüş-external view

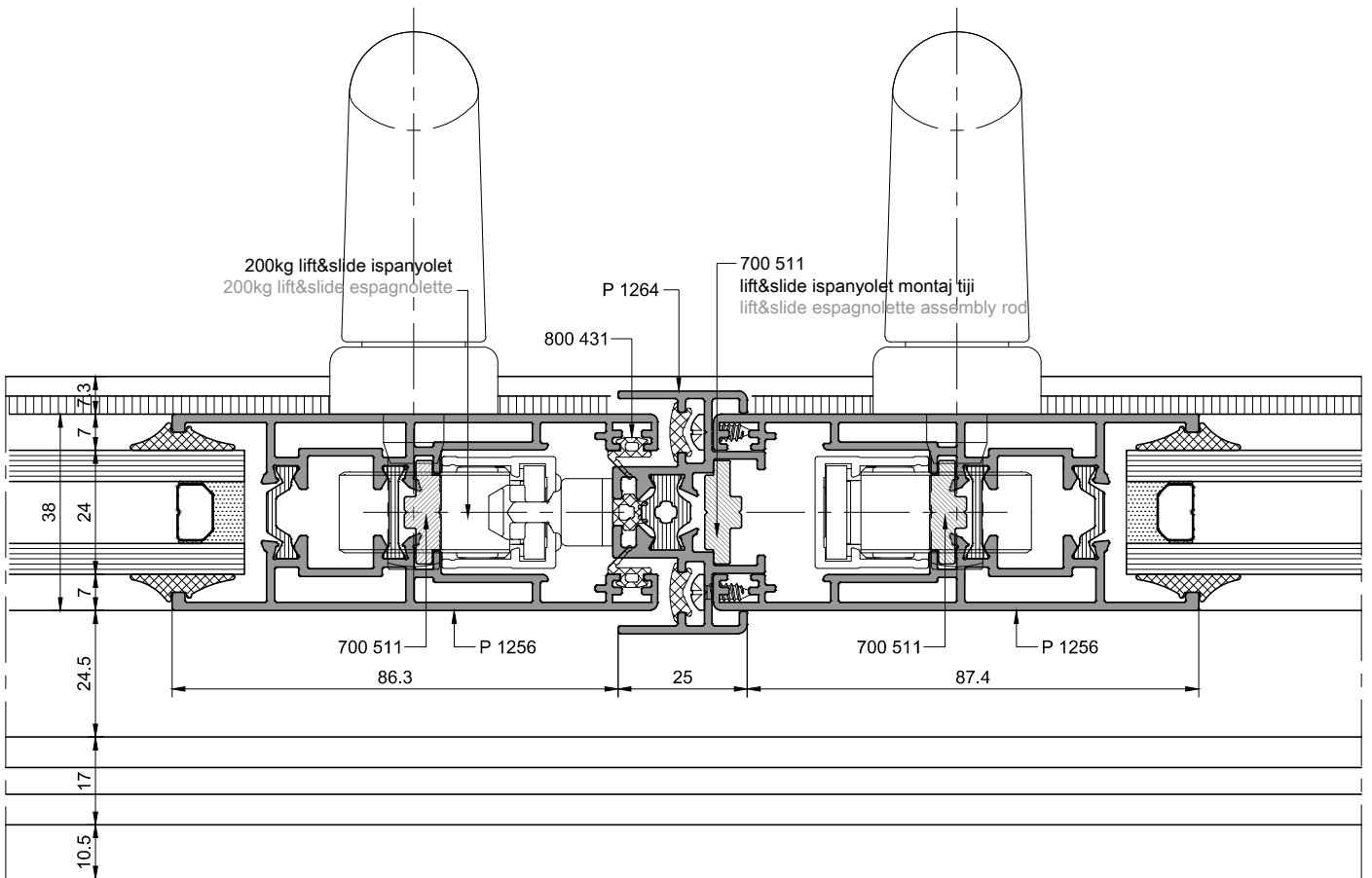

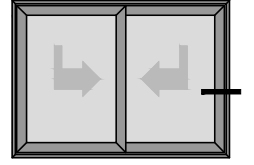

dış görünüş - external view

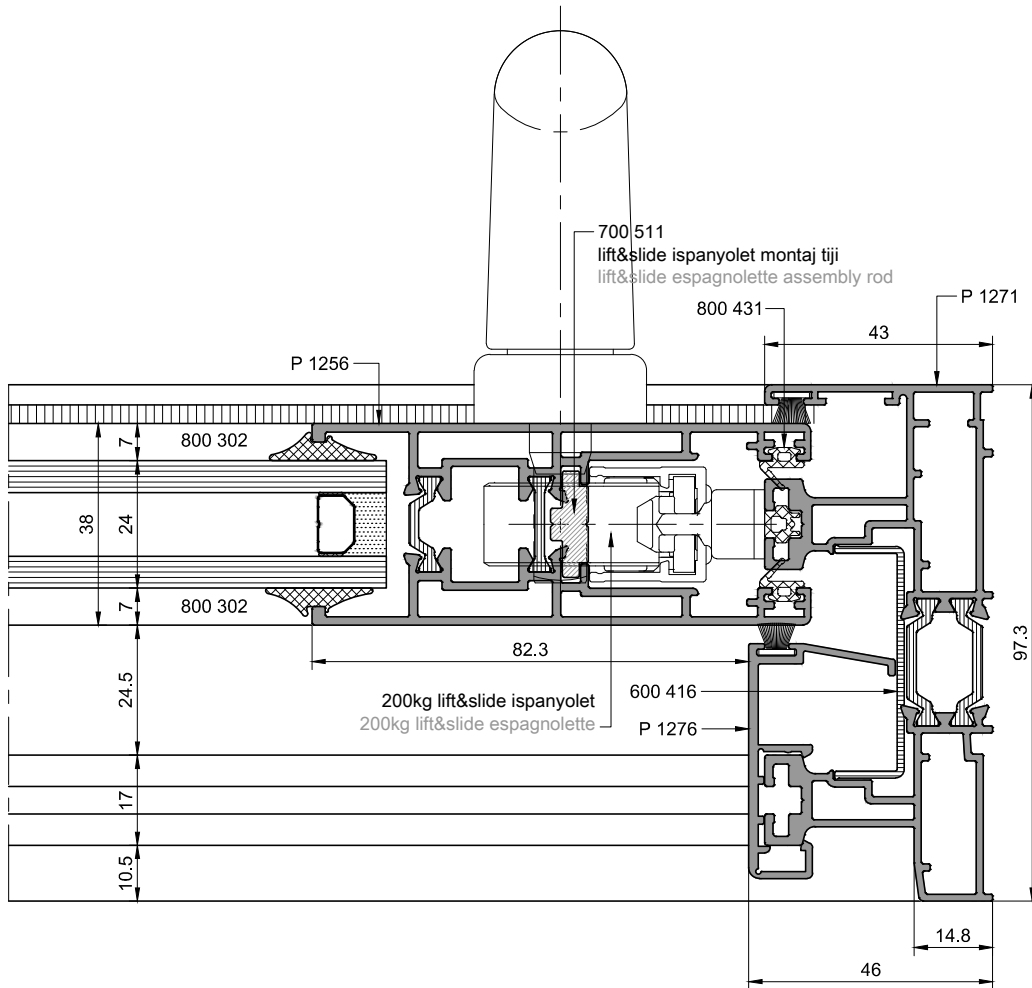

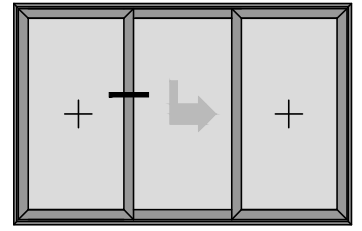

dış görünüş-external view

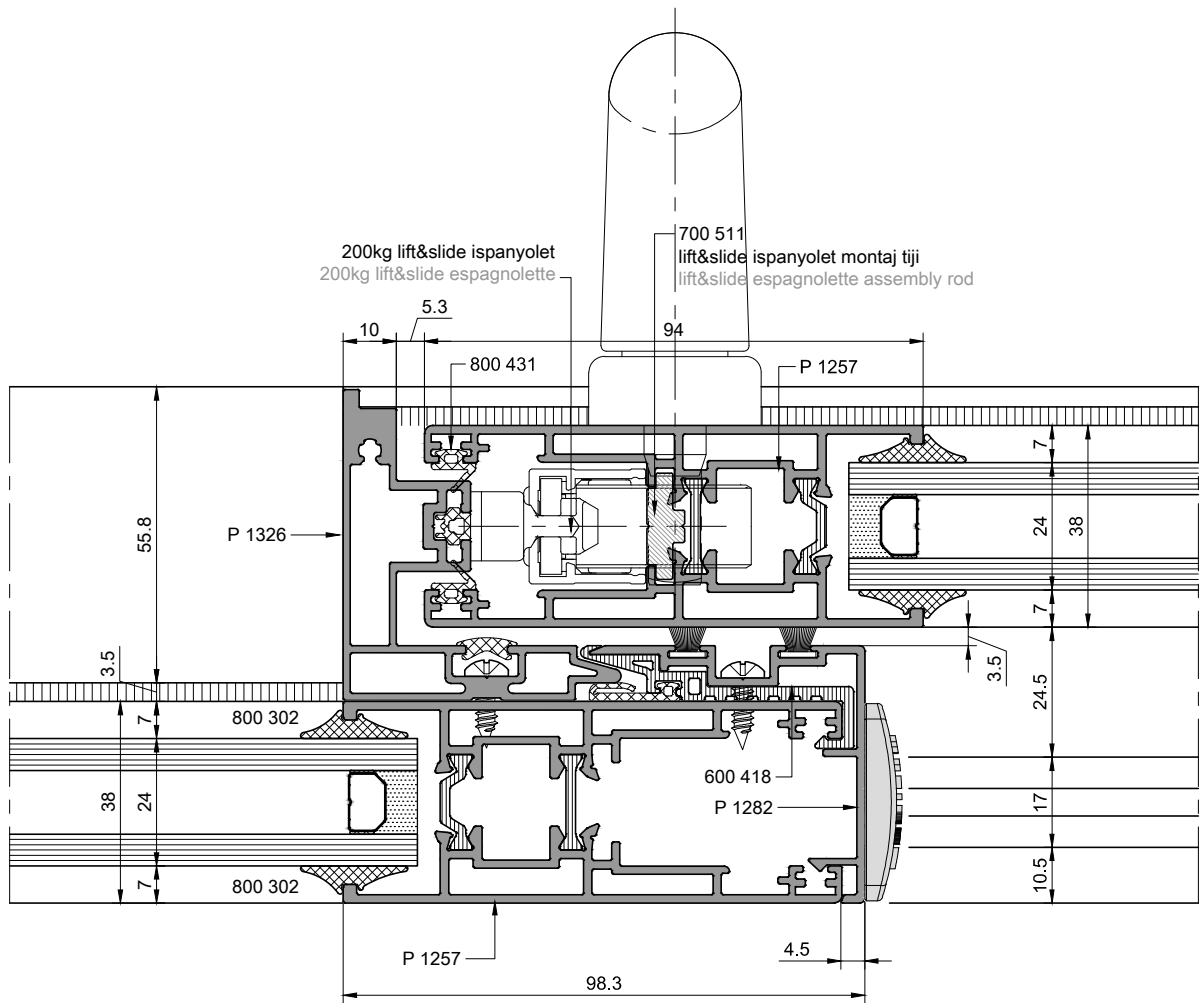

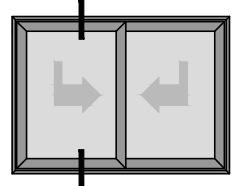
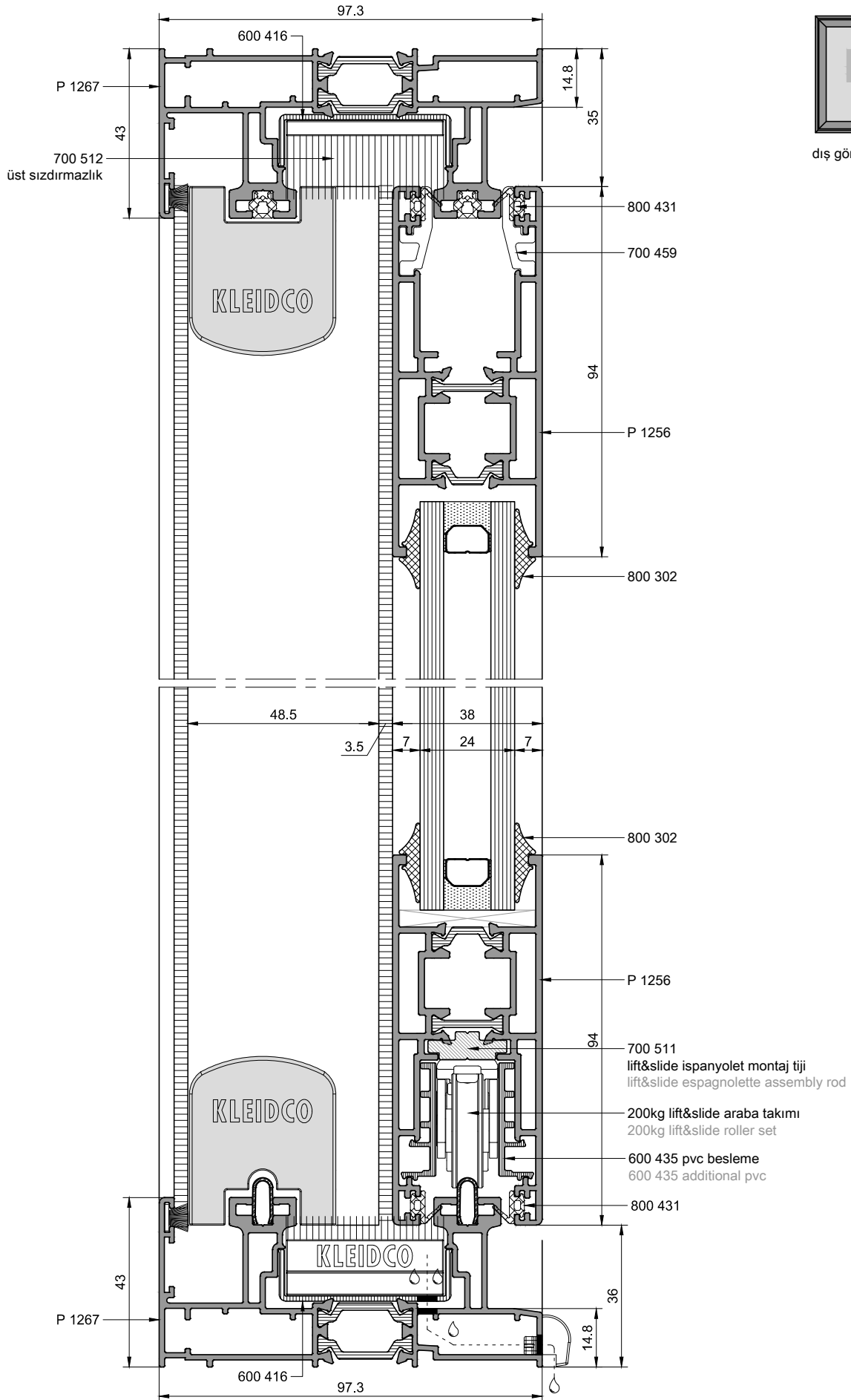

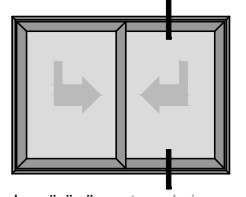
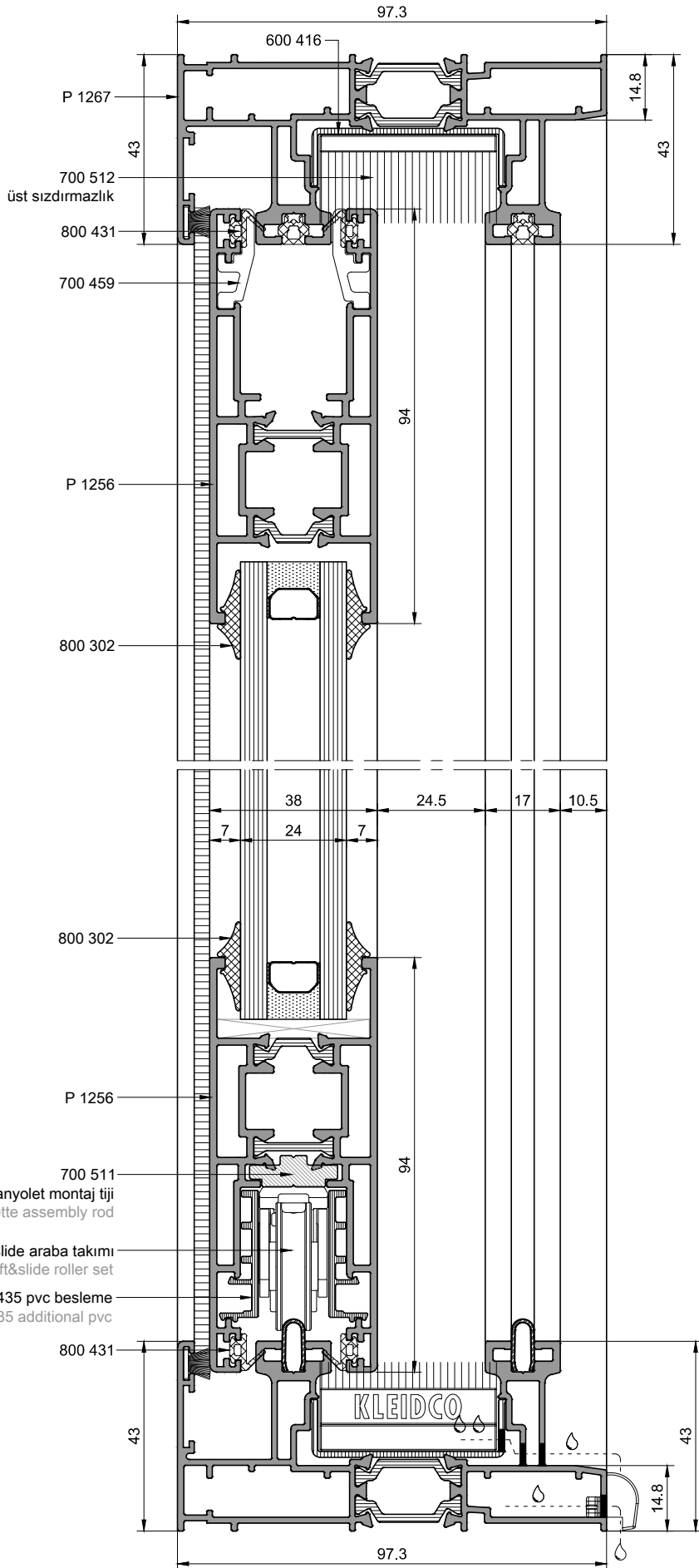

dış görünüş-external view