

FS50

STİCK GİYDİRME CEPHE SİSTEMİ

STICK CURTAIN WALL SYSTEM

X	PERFORMANS ve ISI HESAPLARI PERFORMANCE and THERMAL CALCULATIONS	X-01 / X-07
A	ALÜMİNYUM PROFİLLER ALUMINIUM PROFILES	A-01 / A-11
B	CAM MONTAJ TALİMATI GLAZING ASSEMBLY	B-01 / B-44
C	CONTALAR GASKETS	C-01 / C-05
D	AKSESUARLAR ACCESSORIES	D-01 / D-04
E	PVC PROFİLLER PVC PROFILES	E-01 / E-01
F	TAM ÖLÇEKLİ PROFİLLER FULL SCALE PROFILES	F-01 / F-45
G	PRENSİP SİSTEM DETAYLARI PRINCIPAL SECTIONS	G-01 / G-65

FS50
STICK GİYDİRME CEPHE SİSTEMİ
STICK CURTAIN WALL SYSTEM

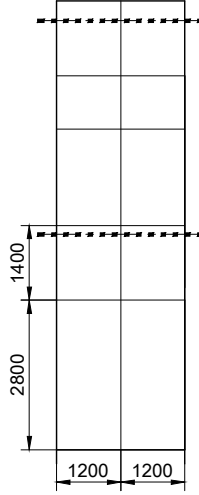
PERFORMANS TESTİ - performance test	
 <p>2400 x 8710</p>	
TS EN 12152 - HAVA GEÇİRGENLİĞİ TS EN 12152 - air permability	A 4 (± 600 pa)
TS EN 12154 - SU SIZDIRMAZLIĞI TS EN 12154 - water tightness	RE 900 (± 900 pa) RE 900 (± 900 pa)
TS EN 13830 - RÜZGAR YÜKÜ DAYANIMI TS EN 13830 - resistance to design wind load	(± 960 pa)
TS EN 13830 - ARTTIRILMIŞ RÜZGAR YÜKÜ DAYANIMI TS EN 13830 - resistance to safety wind load	(± 1440 pa)
AAMA 501.4 - STATİK SİSMİK YATAY HAREKET AAMA 501.4 - static seismic horizontal movement	SAGA-SOLA ± 42 mm to left & right ± 42 mm
AAMA 501.4 - GÜVENLİK AAMA 501.4 - safety	SAGA-SOLA ± 84 mm to left & right ± 84 mm
TS EN 14019 - DARBE DAYANIM TS EN 14019 - Impact resistance	E5
LABORATUAR ve TEST RAPORU NUMARASI Laboratory and test report number	FTI facade testing institute 020.052.PR01/2020

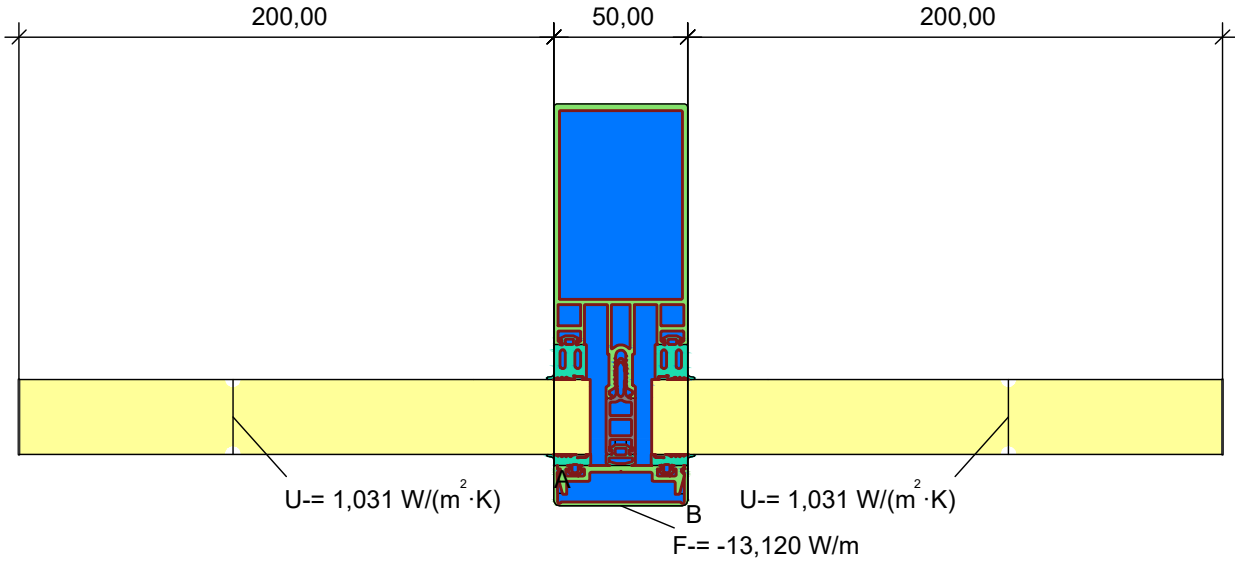

$$U_{f,A,B} = \frac{\Phi}{DT} = \frac{13,120}{24,000} = \frac{13,120}{0,050} = 2,69 \text{ W}/(\text{m}^2 \cdot \text{K})$$

Material	l [W/(m·K)]	ϵ	Boundary Condition	q [W/m ²]	R [(m ² ·K)/W]	ϵ
Aluminium (Si alloys)	160,000	0,900	Epsilon 0.9			0,900
EPDM (ethylene propylene diene monomer)	0,250	0,900	Exterior, frame	-2,000	0,040	
PVC-U (polyvinylchloride), rigid	0,170	0,900	Interior, frame, normal	22,000	0,130	
Panel	0,035	0,900	Interior, frame, reduced	22,000	0,200	
Unventilated air cavity			Symmetry/Model section	0,000		

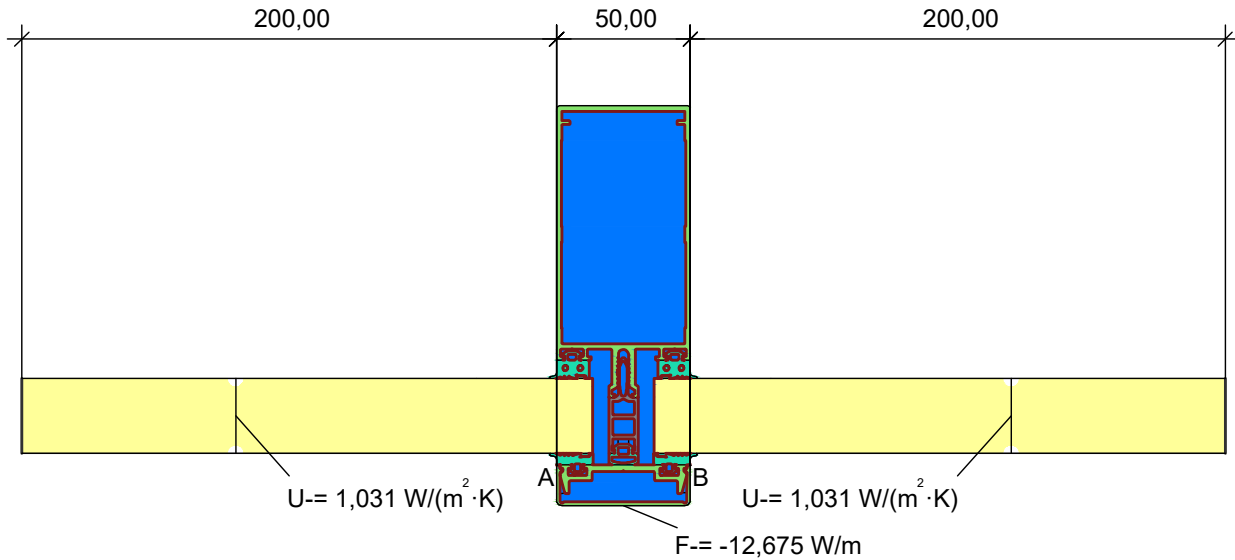

$$U_{f,A,B} = \frac{\Phi}{DT} = \frac{12,675}{24,000} = \frac{12,675}{0,050} = 2,31 \text{ W}/(\text{m}^2 \cdot \text{K})$$

Material	l [W/(m·K)]	ϵ	Boundary Condition	q [W/m ²]	R [(m ² ·K)/W]	ϵ
Aluminium (Si alloys)	160,000	0,900	Epsilon 0.9			0,900
EPDM (ethylene propylene diene monomer)	0,250	0,900	Exterior, frame	-2,000	0,040	
PVC-U (polyvinylchloride), rigid	0,170	0,900	Interior, frame, normal	22,000	0,130	
Panel	0,035	0,900	Interior, frame, reduced	22,000	0,200	
Unventilated air cavity			Symmetry/Model section	0,000		

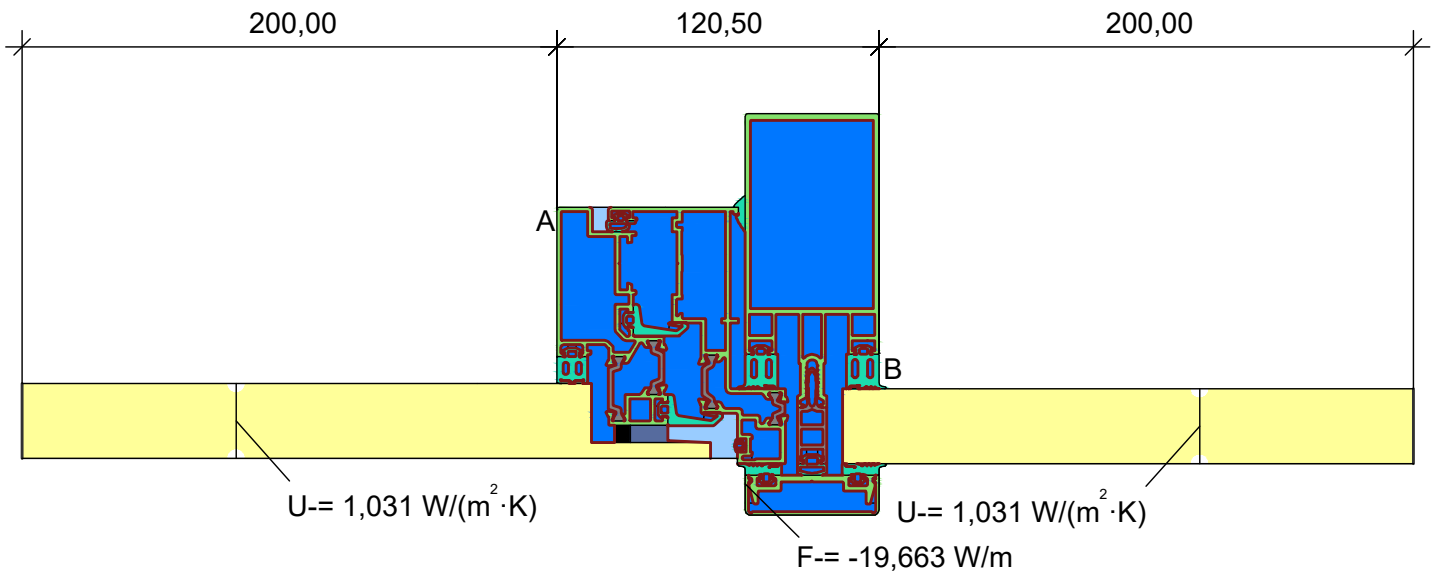

$$U_{f,A,B} = \frac{\Phi}{DT} = \frac{19,663}{24,000} - 1,031 \cdot 0,200 - 1,031 \cdot 0,200 = 3,38 \text{ W}/(\text{m}^2 \cdot \text{K})$$

U_{f,A,B} bf 0,121

Material	λ [W/(m·K)]	ϵ	Boundary Condition	q [W/m ²]	q [°C]	R [(m ² ·K)/W]	ϵ
Aluminium (Si alloys)	160,000	0,900	Epsilon 0.9				0,900
EPDM (ethylene propylene diene monomer)	0,250	0,900	Exterior, frame	-2,000		0,040	
FOAM	0,038	0,900	Interior, frame, normal	22,000		0,130	
PVC-U (polyvinylchloride), rigid	0,170	0,900	Interior, frame, reduced	22,000		0,200	
Panel	0,035	0,900	Symmetry/Model section	0,000			
Polyamid 6.6 with 25% glass fibre	0,300	0,900					
Silicone, pure	0,350	0,900					
Slightly ventilated air cavity							
Unventilated air cavity							

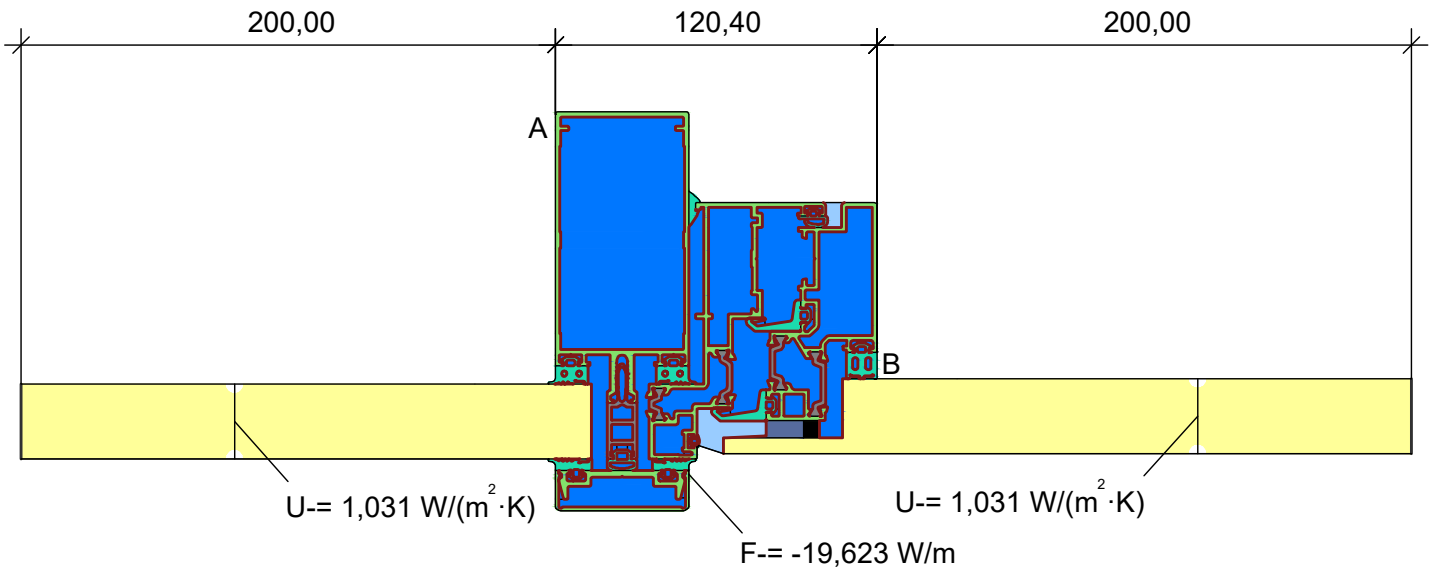

$$U_{f,A,B} = \frac{\Phi}{DT} = \frac{19,623}{24,000} - \frac{1,031 \cdot 0,200 - 1,031 \cdot 0,200}{0,120} = 3,37 \text{ W}/(\text{m}^2 \cdot \text{K})$$

Material	l [W/(m·K)]	ϵ	Boundary Condition	q [W/m ²]	q [C°]	R [(m ² ·K)/W]	ϵ
Aluminium (Si alloys)	160,000	0,900	Epsilon 0.9				0,900
EPDM (ethylene propylene diene monomer)	0,250	0,900	Exterior, frame	-2,000		0,040	
FOAM	0,038	0,900	Interior, frame, normal	22,000		0,130	
PVC-U (polyvinylchloride), rigid	0,170	0,900	Interior, frame, reduced	22,000		0,200	
Panel	0,035	0,900	Symmetry/Model section	0,000			
Polyamid 6.6 with 25% glass fibre	0,300	0,900					
Silicone, pure	0,350	0,900					
Slightly ventilated air cavity							
Unventilated air cavity							

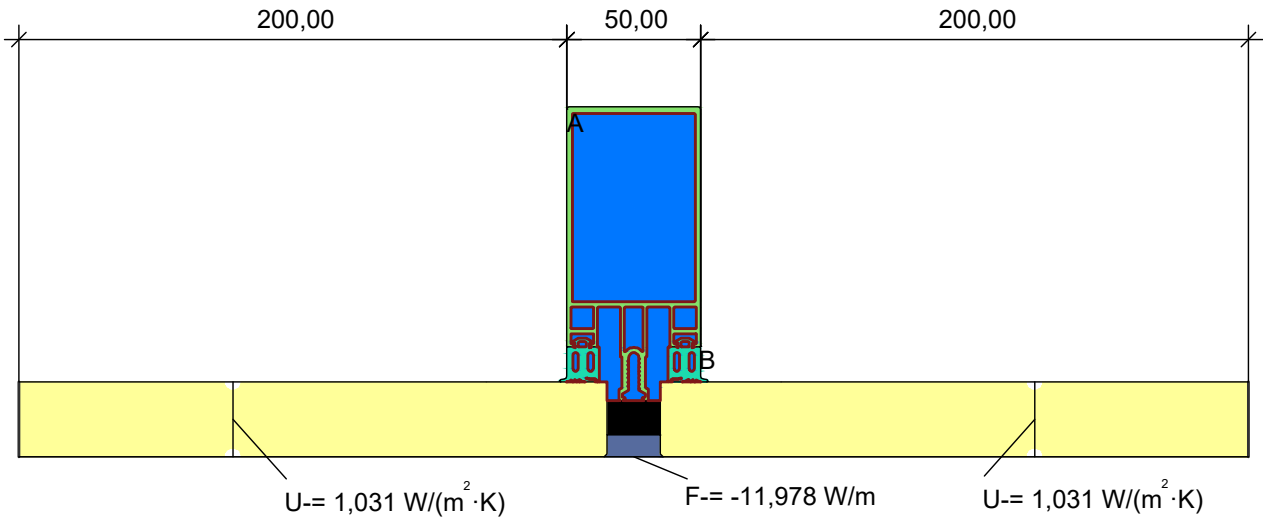

$$U_{f,A,B} = \frac{\frac{\Phi}{DT} - U_{p1} \cdot b_{p1} - U_{p2} \cdot b_{p2}}{b_f} = \frac{\frac{11,978}{24,000} - 1,031 \cdot 0,205 - 1,031 \cdot 0,205}{0,050} = 1,53 \text{ W}/(\text{m}^2 \cdot \text{K})$$

Material	l [W/(m·K)]	ϵ	Boundary Condition	q [W/m ²]	$q[C^\circ]$	R [(m ² ·K)/W]	ϵ
Aluminium (Si alloys)	160,000	0,900	Epsilon 0.9				0,900
EPDM (ethylene propylene diene monomer)	0,250	0,900	Exterior, frame	-2,000			0,040
FOAM	0,038	0,900	Interior, frame, normal	22,000			0,130
Panel	0,035	0,900	Interior, frame, reduced	22,000			0,200
Silicone, pure	0,350		Symmetry/Model section	0,000			
Unventilated air cavity							

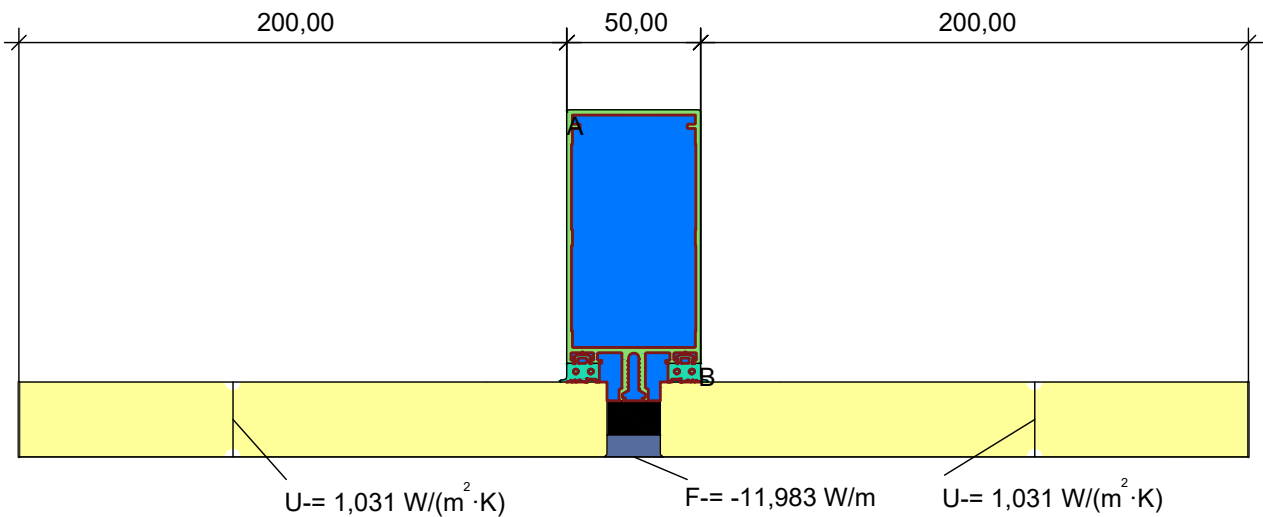

$$U_{f,A,B} = \frac{\frac{\Phi}{DT} - U_{p1} \cdot b_{p1} - U_{p2} \cdot b_{p2}}{b_f} = \frac{\frac{11,983}{24,000} - 1,031 \cdot 0,205 - 1,031 \cdot 0,205}{0,050} = 1,53 \text{ W}/(\text{m}^2 \cdot \text{K})$$

Material	l [W/(m·K)]	ϵ	Boundary Condition	q [W/m ²]	$q[C^\circ]$	R [(m ² ·K)/W]	ϵ
Aluminium (Si alloys)	160,000	0,900	Epsilon 0.9				0,900
EPDM (ethylene propylene diene monomer)	0,250	0,900	Exterior, frame	-2,000			0,040
FOAM	0,038	0,900	Interior, frame, normal	22,000			0,130
Panel	0,035	0,900	Interior, frame, reduced	22,000			0,200
Silicone, pure	0,350		Symmetry/Model section	0,000			
Unventilated air cavity							

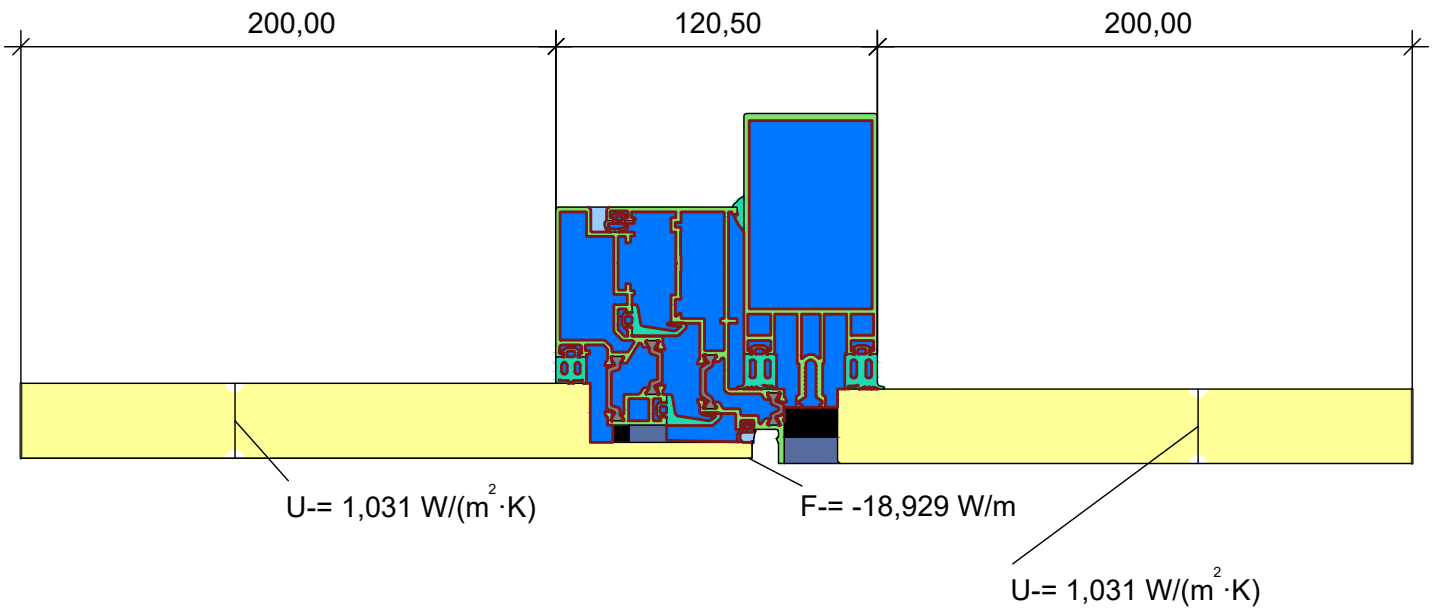

$$U_{f, \text{bf}} = \frac{\Phi}{DT} = \frac{18,929}{24,000} - \frac{1,031 \cdot 0,200 - 1,031 \cdot 0,200}{0,121} = 3,12 \text{ W/(m}^2 \cdot \text{K)}$$

Material	l [W/(m·K)]	ε	Boundary Condition	q [W/m ²]	q [C°]	R [(m ² ·K)/W]	ε
Aluminium (Si alloys)	160,000	0,900	Epsilon 0,9				0,900
EPDM (ethylene propylene diene monomer)	0,250	0,900	Exterior, frame	-2,000		0,040	
FOAM	0,038	0,900	Interior, frame, normal	22,000		0,130	
Panel	0,035	0,900	Interior, frame, reduced	22,000		0,200	
Polyamid 6.6 with 25% glass fibre	0,300	0,900	Symmetry/Model section	0,000			
Silicone, pure	0,350	0,900					
Slightly ventilated air cavity							
Unventilated air cavity							

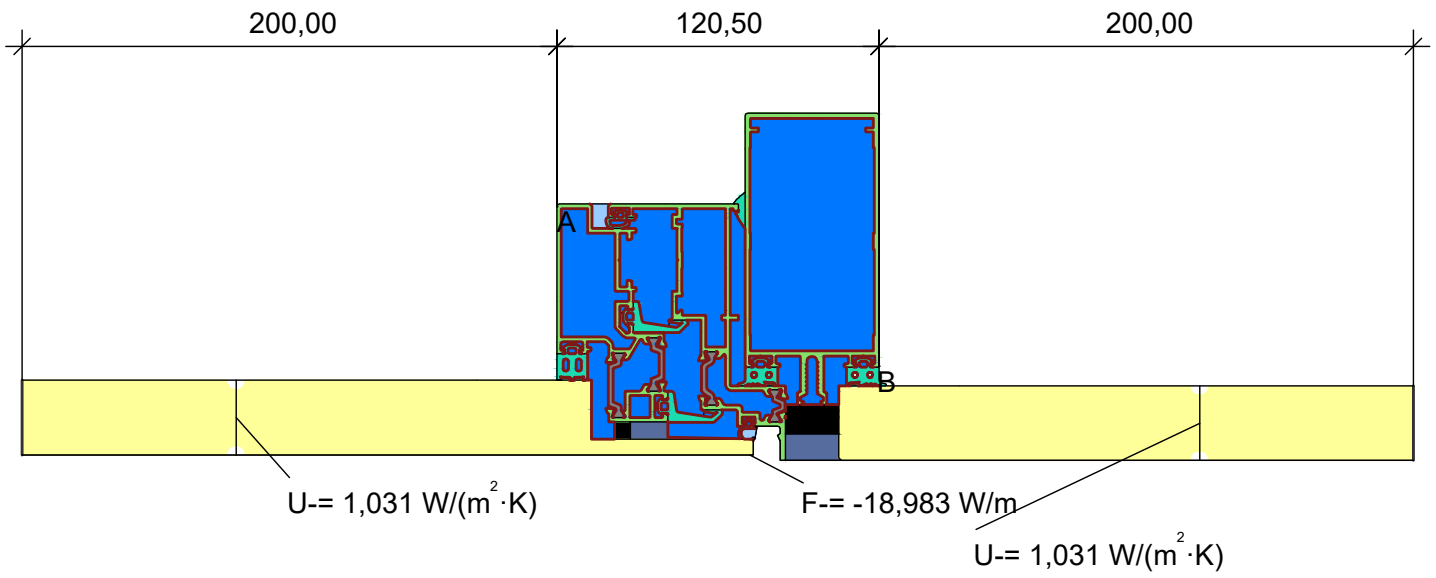

$$U_{f,A,B} = \frac{\Phi}{DT} = \frac{18,983}{24,000} = 0,791$$











$$U_{f,A,B} = \frac{18,983}{0,121} = 156,884$$

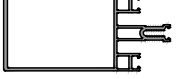







$$U_{f,A,B} = \frac{18,983}{0,121} - 1,031 \cdot 0,200 - 1,031 \cdot 0,200 = 3,14 \text{ W/(m}^2 \cdot \text{K)}$$

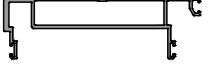

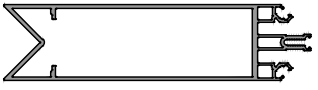

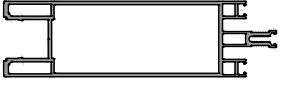



Material	λ [W/(m·K)]	ε	Boundary Condition	q [W/m ²]	T [C]	R [(m ² ·K)/W]	ε
Aluminium (Si alloys)	160,000	0,900	Epsilon 0.9				0,900
EPDM (ethylene propylene diene monomer)	0,250	0,900	Exterior, frame	-2,000		0,040	
FOAM	0,038	0,900	Interior, frame, normal	22,000		0,130	
Panel	0,035	0,900	Interior, frame, reduced	22,000		0,200	
Polyamid 6.6 with 25% glass fibre	0,300	0,900	Symmetry/Model section	0,000			
Silicone, pure	0,350	0,900					
Slightly ventilated air cavity							
Unventilated air cavity							



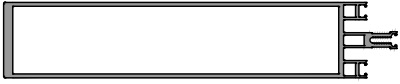



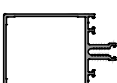
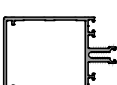

FS50
STICK GİYDİRME CEPHE SİSTEMİ
STICK CURTAIN WALL SYSTEM





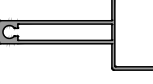



ALUMİNYUM PROFİLLER
ALUMINIUM PROFILES







PROFİL ŞEKLİ PROFILE SECTION	PROFİL ADI PROFILE NO	KALIP KODU DIE NO	PROFİL TANIMI PROFILE DESCRIPTION	AĞIRLIK WEIGHT
	P 1380	12034	18mm DÜŞEY PROFİL 18mm mullion profile	1,175kg/mt
	P 1381	K 731	80mm DÜŞEY PROFİL 80mm mullion profile	2,160kg/mt
	P 1382	11462	90mm DÜŞEY PROFİL 90mm mullion profile	2,145kg/mt
	P 1383	11465	90°DÜŞEY KÖŞE PROFİL 90°mullion corner profile	2,835kg/mt
	P 1384	14083	100mm DÜŞEY PROFİL 100mm mullion profile	1,855kg/mt
	P 1385	9835	105mm DÜŞEY PROFİL 105mm mullion profile	2,430kg/mt
	P 1386	12396	105mm DÜŞEY PROFİL 105mm mullion profile	2,550kg/mt
	P 1387	11928	115mm DÜŞEY PROFİL 115mm mullion profile	2,105kg/mt
	P 1388	11240	130mm DÜŞEY PROFİL 130mm mullion profile	3,740kg/mt
	P 1389	K 733	130mm DÜŞEY PROFİL 130mm mullion profile	2,920kg/mt

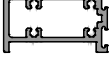

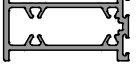
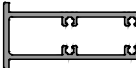
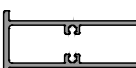
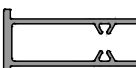
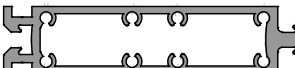





PROFİL ŞEKLİ PROFILE SECTION	PROFİL ADI PROFILE NO	KALIP KODU DIE NO	PROFİL TANIMI PROFILE DESCRIPTION	AĞIRLIK WEIGHT
	P 1390	12355	130mm DİŞİ DÜŞEY PROFİL 130mm female mullion profile	2,270kg/mt
	P 1391	12354	130mm ERKEK DÜŞEY PROFİL 130mm male mullion profile	1,850kg/mt
	P 1392	12190	130mm DÜŞEY PROFİL 130mm mullion profile	2,500kg/mt
	P 1393	11457	90°DÜŞEY KÖŞE PROFİL 90°mullion corner profile	3,920kg/mt
	P 1394	11915	150mm DÜŞEY PROFİL 150mm mullion profile	3,065kg/mt
	P 1395	K 734	155mm DÜŞEY PROFİL 155mm mullion profile	3,660kg/mt
	P 1858	16911	160mm DÜŞEY PROFİL 160mm mullion profile	3,587kg/mt
	P 1396	12518	160mm DÜŞEY PROFİL 160mm mullion profile	2,900kg/mt
	P 1397	12656	160mm DÜŞEY PROFİL 160mm mullion profile	2,610kg/mt
	P 1860	15750	180mm DÜŞEY PROFİL 180mm mullion profile	4,450kg/mt







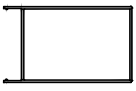
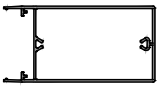

PROFİL ŞEKLİ PROFILE SECTION	PROFİL ADI PROFILE NO	KALIP KODU DIE NO	PROFİL TANIMI PROFILE DESCRIPTION	AĞIRLIK WEIGHT
	P 1398	13913	195mm DÜŞEY PROFİL 195mm mullion profile	3,445kg/mt
	P 1399	11705	205mm DÜŞEY PROFİL 205mm mullion profile	4,760kg/mt
	P 1400	9838	240mm DÜŞEY PROFİL 240mm mullion profile	5,110kg/mt
	P 1994	17238	250mm DÜŞEY PROFİL 250mm mullion profile	6,110kg/mt
	P 1859	15815	265mm DÜŞEY PROFİL 265mm mullion profile	10,320kg/mt
	P 1401	10721	6mm YATAY PROFİL 6mm transom profile	0,600kg/mt
	P 1402	12035	23mm YATAY PROFİL 23mm transom profile	1,030kg/mt
	P 1403	11930	60mm YATAY PROFİL 60mm transom profile	1,350kg/mt
	P 1404	K 741	60mm YATAY PROFİL 60mm transom profile	1,410kg/mt
	P 1857	16913	60mm YATAY PROFİL 60mm transom profile	1,451kg/mt



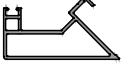
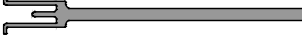



PROFİL ŞEKLİ PROFILE SECTION	PROFİL ADI PROFILE NO	KALIP KODU DIE NO	PROFİL TANIMI PROFILE DESCRIPTION	AĞIRLIK WEIGHT
	P 1405	K 742	85mm YATAY PROFİL 85mm transom profile	1,640kg/mt
	P 1944	17109	85mm YATAY PROFİL 85mm transom profile	1,674kg/mt
	P 1406	11463	95mm YATAY PROFİL 95mm transom profile	1,735kg/mt
	P 1407	14082	105mm YATAY PROFİL 105mm transom profile	1,660kg/mt
	P 1408	9836	110mm YATAY PROFİL 110mm transom profile	1,915kg/mt
	P 1409	12397	110mm YATAY PROFİL 110mm transom profile	2,210kg/mt
	P 1856	16101	110mm YATAY PROFİL 110mm transom profile	1,897kg/mt
	P 1410	11929	120mm YATAY PROFİL 120mm transom profile	1,940kg/mt
	P 1411	K 744	135mm YATAY PROFİL 135mm transom profile	2,160kg/mt
	P 1855	16234	135mm YATAY PROFİL 135mm transom profile	2,113kg/mt





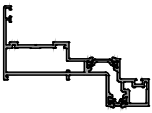
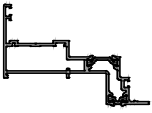
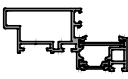
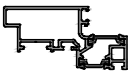





PROFİL ŞEKLİ PROFILE SECTION	PROFİL ADI PROFILE NO	KALIP KODU DIE NO	PROFİL TANIMI PROFILE DESCRIPTION	AĞIRLIK WEIGHT
	P 1412	11916	155mm YATAY PROFİL 155mm transom profile	2,485kg/mt
	P 1413	K 745	160mm YATAY PROFİL 160mm transom profile	2,540kg/mt
	P 1414	12517	165mm YATAY PROFİL 165mm transom profile	2,400kg/mt
	P 1854	16910	165mm YATAY PROFİL 165mm transom profile	3,020kg/mt
	P 1853	15751	165mm YATAY PROFİL 165mm transom profile	2,553kg/mt
	P 1993	17231	185mm YATAY PROFİL 185mm transom profile	2,965kg/mt
	P 1415	13912	200mm YATAY PROFİL 200mm transom profile	2,975kg/mt
	P 1416	11737	210mm YATAY PROFİL 210mm transom profile	4,270kg/mt
	P 1417	9839	245mm YATAY PROFİL 245mm transom profile	4,850kg/mt
	P 1418	11464	68,6mm DİLATASYON PROFİLİ 68,6mm dilatation profile	2,240kg/mt

PROFİL ŞEKLİ PROFILE SECTION	PROFİL ADI PROFILE NO	KALIP KODU DIE NO	PROFİL TANIMI PROFILE DESCRIPTION	AĞIRLIK WEIGHT
	P 1419	9832	82,6mm DİLATASYON PROFİLİ 82,6mm dilatation profile	2,485kg/mt
	P 1420	13117	95,5mm DİLATASYON PROFİLİ 95,5mm dilatation profile	2,650kg/mt
	P 1421	11626	107,3mm DİLATASYON PROFİLİ 107,3mm dilatation profile	2,840kg/mt
	P 1422	K 1805	128,5mm DİLATASYON PROFİLİ 128,5 dilatation profile	3,410kg/mt
	P 1423	8053	200mm DİLATASYON PROFİLİ 200mm dilatation profile	7,880kg/mt
	P 1424	11130	YATAY MONTAJ PROFİLİ transom connector profile	0,945kg/mt
	P 1425	9837	YATAY MONTAJ PROFİLİ transom connector profile	0,920kg/mt
	P 1426	14913	AÇILI YATAY MONTAJ PROFİLİ angular transom connector profile	1,140kg/mt
	P 1038	9840	BASKI PROFİLİ pressure plate profile	0,460kg/mt
	P 1427	14914	BASKI PROFİLİ pressure plate profile	0,545kg/mt

PROFİL ŞEKLİ PROFILE SECTION	PROFİL ADI PROFILE NO	KALIP KODU DIE NO	PROFİL TANIMI PROFILE DESCRIPTION	AĞIRLIK WEIGHT
	P 1036	9834	12,5mm KAPAK PROFİLİ 12,5mm cover profile	0,245kg/mt
	P 1037	9833	15mm KAPAK PROFİLİ 15mm cover profile	0,265kg/mt
	P 1428	9895	30mm KAPAK PROFİLİ 30mm cover profile	0,540kg/mt
	P 1429	12398	35mm KAPAK PROFİLİ 35mm cover profile	0,450kg/mt
	P 1945	16802	45mm KAPAK PROFİLİ 45mm cover profile	0,643kg/mt
	P 1946	15446	52mm KAPAK PROFİLİ 52mm cover profile	0,845kg/mt
	P 1947	15447	77mm KAPAK PROFİLİ 77mm cover profile	1,060kg/mt
	P 1948	14495	85mm KAPAK PROFİLİ 85mm cover profile	1,060kg/mt
	P 1430	10458	100mm KAPAK PROFİLİ 100mm cover profile	1,350kg/mt
	P 1431	9966	185mm KAPAK PROFİLİ 185mm cover profile	2,910kg/mt

PROFİL ŞEKLİ PROFILE SECTION	PROFİL ADI PROFILE NO	KALIP KODU DIE NO	PROFİL TANIMI PROFILE DESCRIPTION	AĞIRLIK WEIGHT
	P 1432	13968	90°KÖŞE KAPAK PROFİLİ 90°corner cover profile	1,770kg/mt
	P 1433	13956	KANAL KAPATMA KAPAK PROFİLİ channel closing profile	0,235kg/mt
	P 1852	16912	H KESİTLİ KAPAK PROFİLİ h shape cover profile	0,734kg/mt
	P 1949	17069	90° İÇ KÖŞE ÇITA PROFİLİ 90°interior corner adapter profile	1,195kg/mt
	P 1950	16382	ADAPTÖR PROFİLİ adapter profile	4,390kg/mt
	P 1434	10122	CAM YÜKSELTE PROFİLİ glazing boost profile	0,110kg/mt
	P 1435	11933	CAM YÜKSELTE PROFİLİ glazing boost profile	0,195kg/mt
	P 1436	11917	CAM YÜKSELTE PROFİLİ glazing boost profile	0,280kg/mt
	P 1437	12503	CAM YÜKSELTE PROFİLİ glazing boost profile	0,300kg/mt
	P 1439	K 783	120° DIŞ KÖŞE ÇITA PROFİLİ 120°exterior corner adapter profile	0,170kg/mt

PROFİL ŞEKLİ PROFILE SECTION	PROFİL ADI PROFILE NO	KALIP KODU DIE NO	PROFİL TANIMI PROFILE DESCRIPTION	AĞIRLIK WEIGHT
	P 1440	11392	135° DIŞ KÖŞE ÇITA PROFİLİ 135° exterior corner adapter profile	0,155kg/mt
	P 1441	11442	90° DIŞ KÖŞE ÇITA PROFİLİ 90° exterior corner adapter profile	0,195kg/mt
	P 1442	14908 14909	VASİSTAS PENCERE KASA PROFİLİ frame profile for top hung window	1,735kg/mt
	P 1443	14908 14910	VASİSTAS PENCERE KASA PROFİLİ frame profile for top hung window	1,590kg/mt
	P 1444	12978 13438	VASİSTAS PENCERE KANAT PROFİLİ sash profile for top hung window	1,450kg/mt
	P 1004	12978 12979	VASİSTAS PENCERE KANAT PROFİLİ sash profile for top hung window	1,510kg/mt
	P 1445	10148	CAM TAŞIYICI PROFİL glass support profile	0,235kg/mt
	P 1446	10147	CAM TAŞIYICI PROFİL glass support profile	0,280kg/mt
	P 1447	14124	CAM TAŞIYICI PROFİL glass support profile	0,355kg/mt
	P 1448	13121	CAM TAŞIYICI PROFİL glass support profile	0,385kg/mt

PROFİL ŞEKLİ PROFILE SECTION	PROFİL ADI PROFILE NO	KALIP KODU DIE NO	PROFİL TANIMI PROFILE DESCRIPTION	AĞIRLIK WEIGHT
	P 1449	14-2957	CAM TAŞIYICI PROFİL glass support profile	0,405kg/mt
	P 1450	12036	CAM TAŞIYICI PROFİL glass support profile	0,755kg/mt
	P 1451	11918	CAM TAŞIYICI PROFİL glass support profile	0,505kg/mt
	P 1013	12715	CAM TAŞIYICI PROFİL glass support profile	0,260kg/mt
	P 1951	17106	CAM TAŞIYICI PROFİL glass support profile	0,338kg/mt
	P 1851	16612	CAM TAŞIYICI PROFİL glass support profile	0,251kg/mt
	P 1453	14946	TEK CAM KASET PROFİLİ frame profile for single glass	0,370kg/mt
	P 1452	12767	TEK CAM KASET PROFİLİ frame profile for single glass	0,355kg/mt
	P 1020	12769	TİJ PROFİLİ rod profile	0,105kg/mt
	P 1515	15349 13955	BASIC 56 PENCERE ADAPTÖR PROFİLİ adapter profile for basic56 window	0,935kg/mt

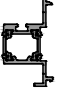
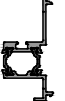
PROFİL ŞEKLİ PROFILE SECTION	PROFİL ADI PROFILE NO	KALIP KODU DIE NO	PROFİL TANIMI PROFILE DESCRIPTION	AĞIRLIK WEIGHT
	P 1531	15349 13955	BASIC 60 PENCERE ADAPTÖR PROFİLİ adapter profile for basic60 window	0,955kg/mt
	P 1220	13954 13955	ICON70 PENCERE ADAPTÖR PROFİLİ adapter profile for icon70 window	0,985kg/mt
	P 1015	338	KÖŞE TAKOZ PROFİLİ corner wedge profile	5,990kg/mt
	P 1016	12254	KÖŞE TAKOZ PROFİLİ corner wedge profile	4,910kg/mt
	P 1017	11182	KÖŞE TAKOZ PROFİLİ corner wedge profile	2,505kg/mt
	P 1069	11652	KÖŞE TAKOZ PROFİLİ corner wedge profile	4,200kg/mt
	P 1288	14133	KÖŞE TAKOZ PROFİLİ corner wedge profile	3,750kg/mt

FS 50
STICK GİYDİRME CEPHE SİSTEMİ
STICK CURTAIN WALL SYSTEM

KAPAKLI CEPHE
CAM KOMBİNASYONLARI
CAPPED FACADE GLASS COMBINATIONS

****düşey profil ile**
22-24-26mm
kalınlıkta cam için
6mm-20mm arası
tek cam kombinasyonu
****with the mullion**
for 22-24-26mm glass
thickness between 6mm
to 20mm single glass
combinations

KAPAKLI CEPHE CAPPED FACADE

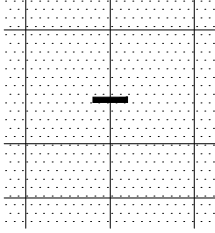

Sayfada bulunan tüm veriler teoriktir.
Lütfen cam ve conta toleranslarını dikkate alınız.
All data on the page are theoretical.
Please consider the glass and gasket tolerance

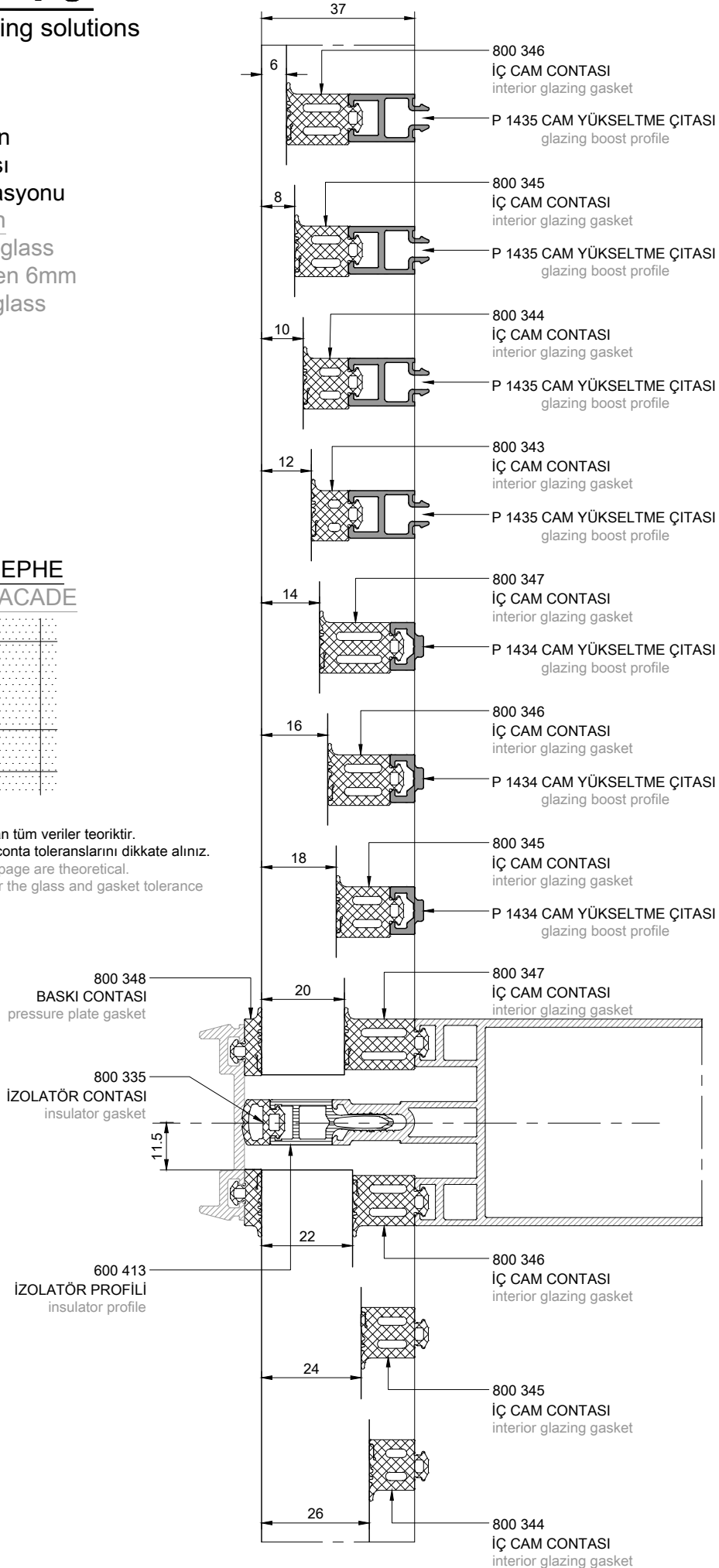

****yatay profil ile**
22-24-26mm
kalınlıkta cam için
6mm-20mm arası
tek cam kombinasyonu
****with the transom**
for 22-24-26mm glass
thickness between 6mm
to 20mm single glass
combinations

KAPAKLI CEPHE CAPPED FACADE

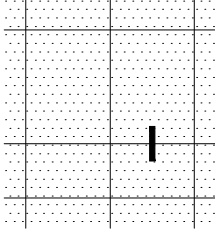

Sayfada bulunan tüm veriler teoriktir.
Lütfen cam ve conta toleranslarını dikkate alınız.
All data on the page are theoretical.
Please consider the glass and gasket tolerance

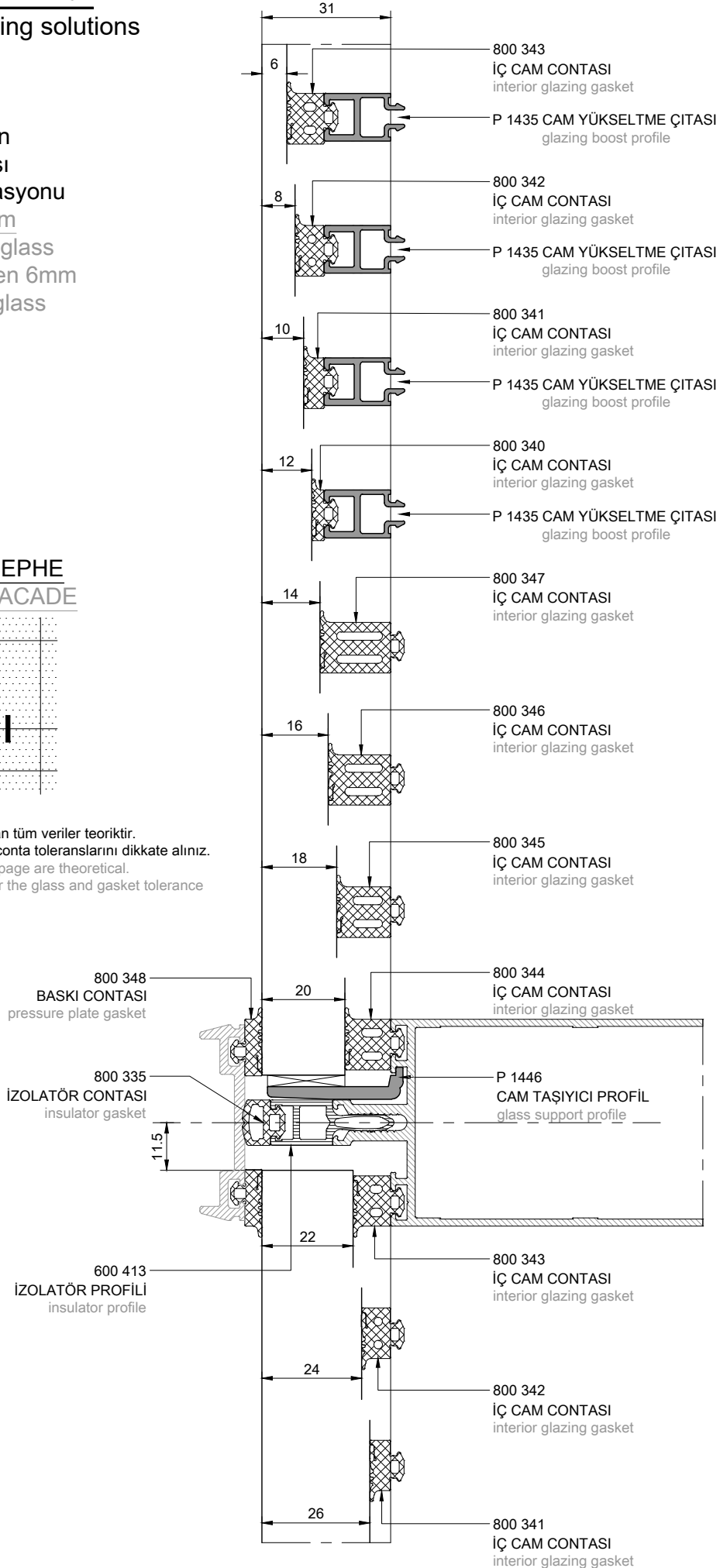

****düşey profil ile**
28-30-32mm
kalınlıkta cam için
6mm-20mm arası
tek cam kombinasyonu
****with the mullion**
for 28-30-32mm glass
thickness between 6mm
to 20mm single glass
combinations

KAPAKLI CEPHE CAPPED FACADE

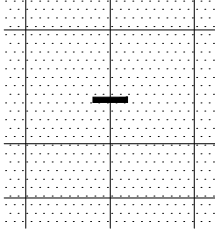

Sayfada bulunan tüm veriler teoriktir.
Lütfen cam ve conta toleranslarını dikkate alınız.
All data on the page are theoretical.
Please consider the glass and gasket tolerance

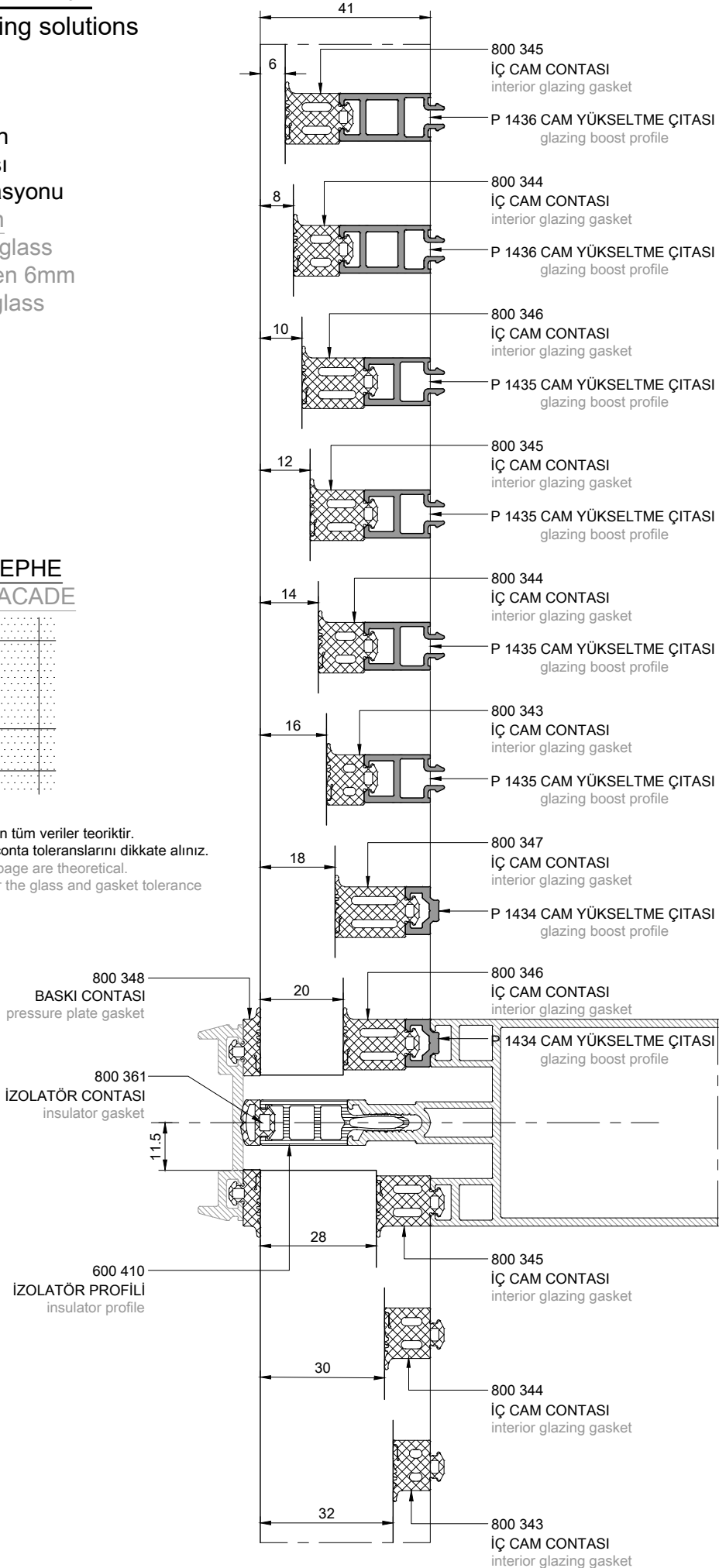

****yatay profil ile**
28-30-32mm
kalınlıkta cam için
6mm-20mm arası
tek cam kombinasyonu
****with the transom**
for 28-30-32mm glass
thickness between 6mm
to 20mm single glass
combinations

KAPAKLI CEPHE CAPPED FACADE

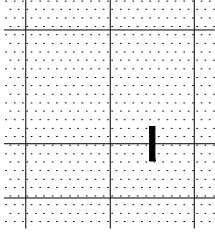

Sayfada bulunan tüm veriler teoriktir.
Lütfen cam ve conta toleranslarını dikkate alınız.
All data on the page are theoretical.
Please consider the glass and gasket tolerance

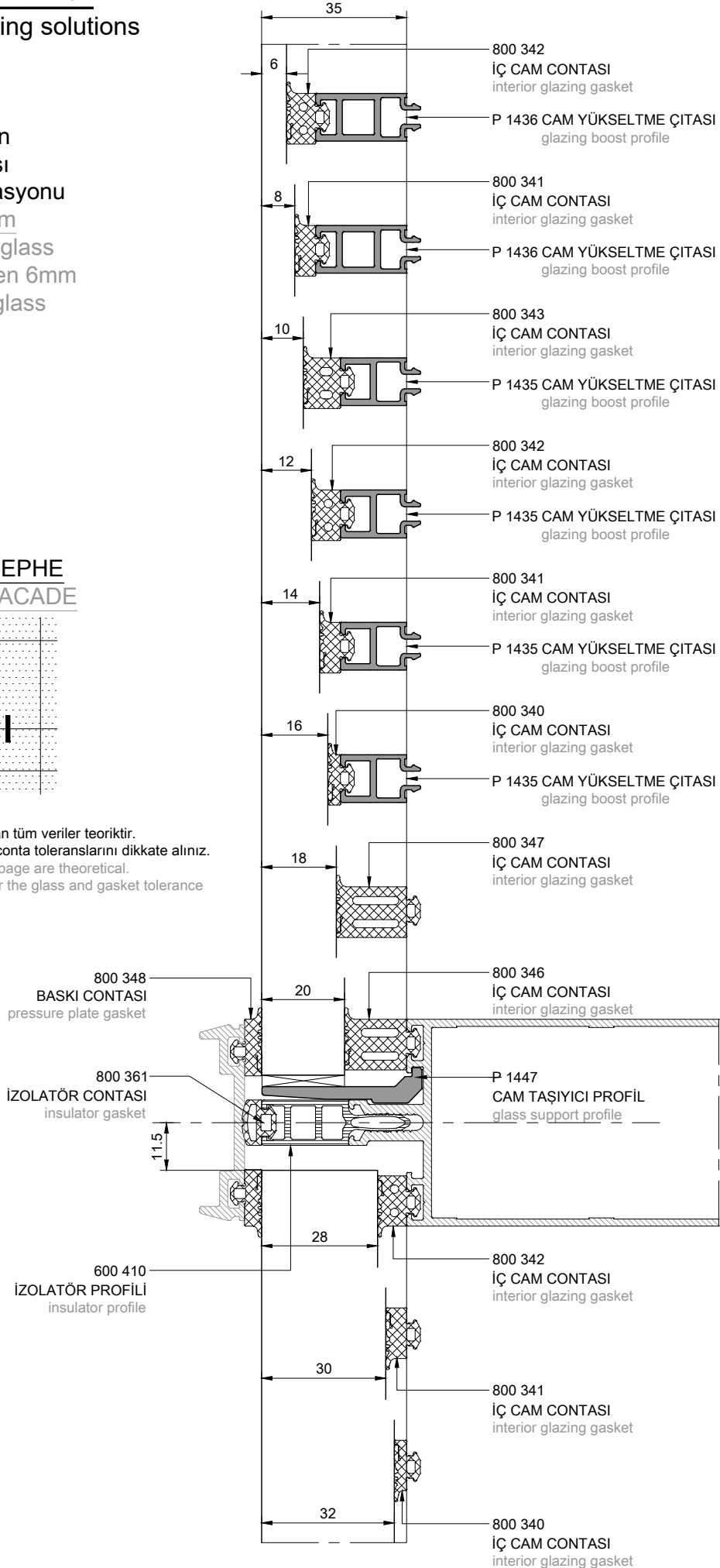

****düşey profil ile**
34-36-38mm
kalınlıkta cam için
6mm-20mm arası
tek cam kombinasyonu
****with the mullion**
for 34-36-38mm glass
thickness between 6mm
to 20mm single glass
combinations

KAPAKLI CEPHE CAPPED FACADE

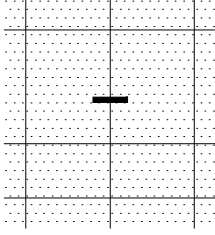

Sayfada bulunan tüm veriler teoriktir.
Lütfen cam ve conta toleranslarını dikkate alınız.
All data on the page are theoretical.
Please consider the glass and gasket tolerance

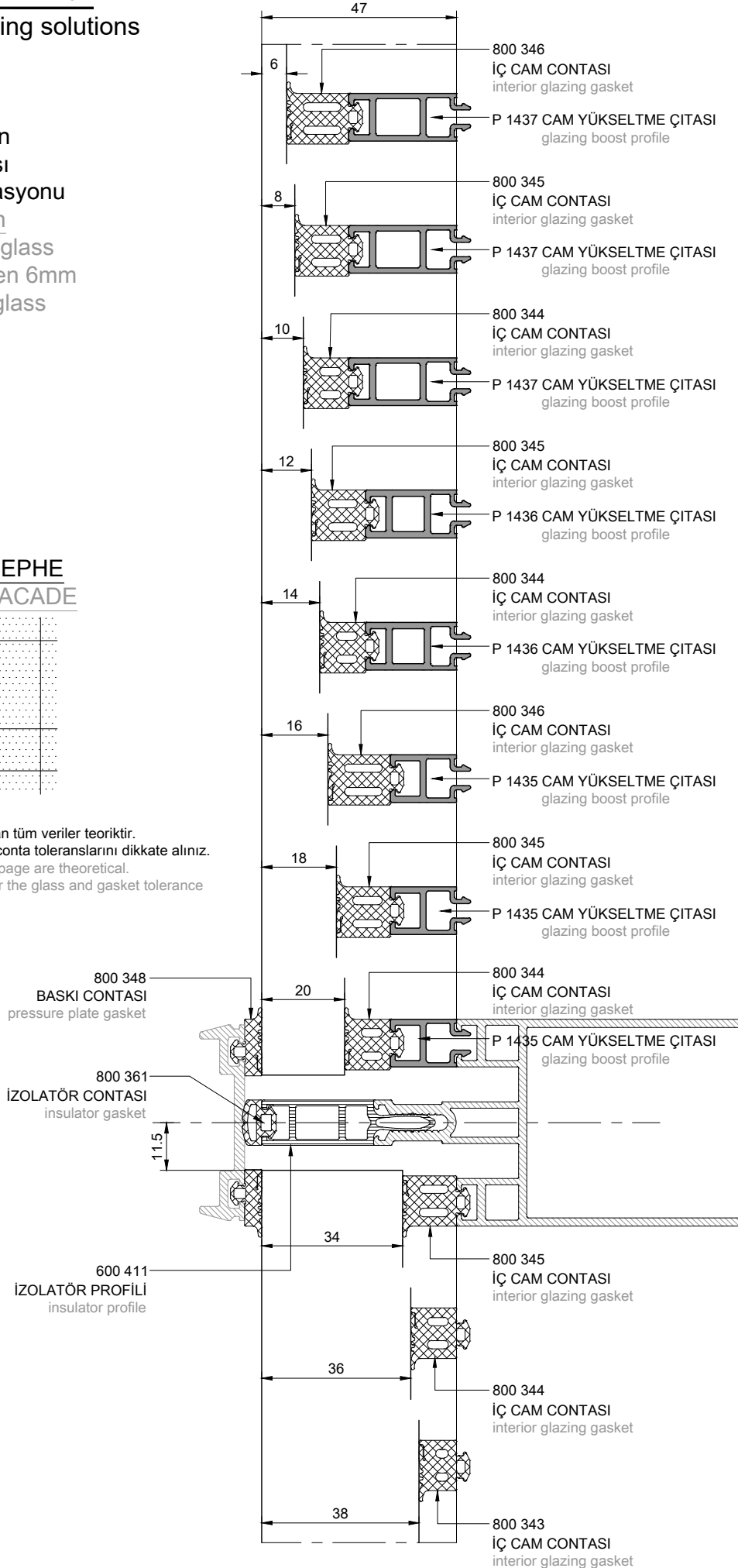

**yatay profil ile

34-36-38mm

kalınlıkta cam için

6mm-20mm arası

tek cam kombinasyonu

**with the transom

for 34-36-38mm glass

thickness between 6mm

to 20mm single glass

combinations

KAPAKLI CEPHE CAPPED FACADE

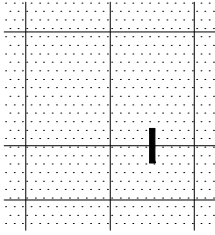

Sayfada bulunan tüm veriler teoriktir.
Lütfen cam ve conta toleranslarını dikkate alınız.
All data on the page are theoretical.
Please consider the glass and gasket tolerance

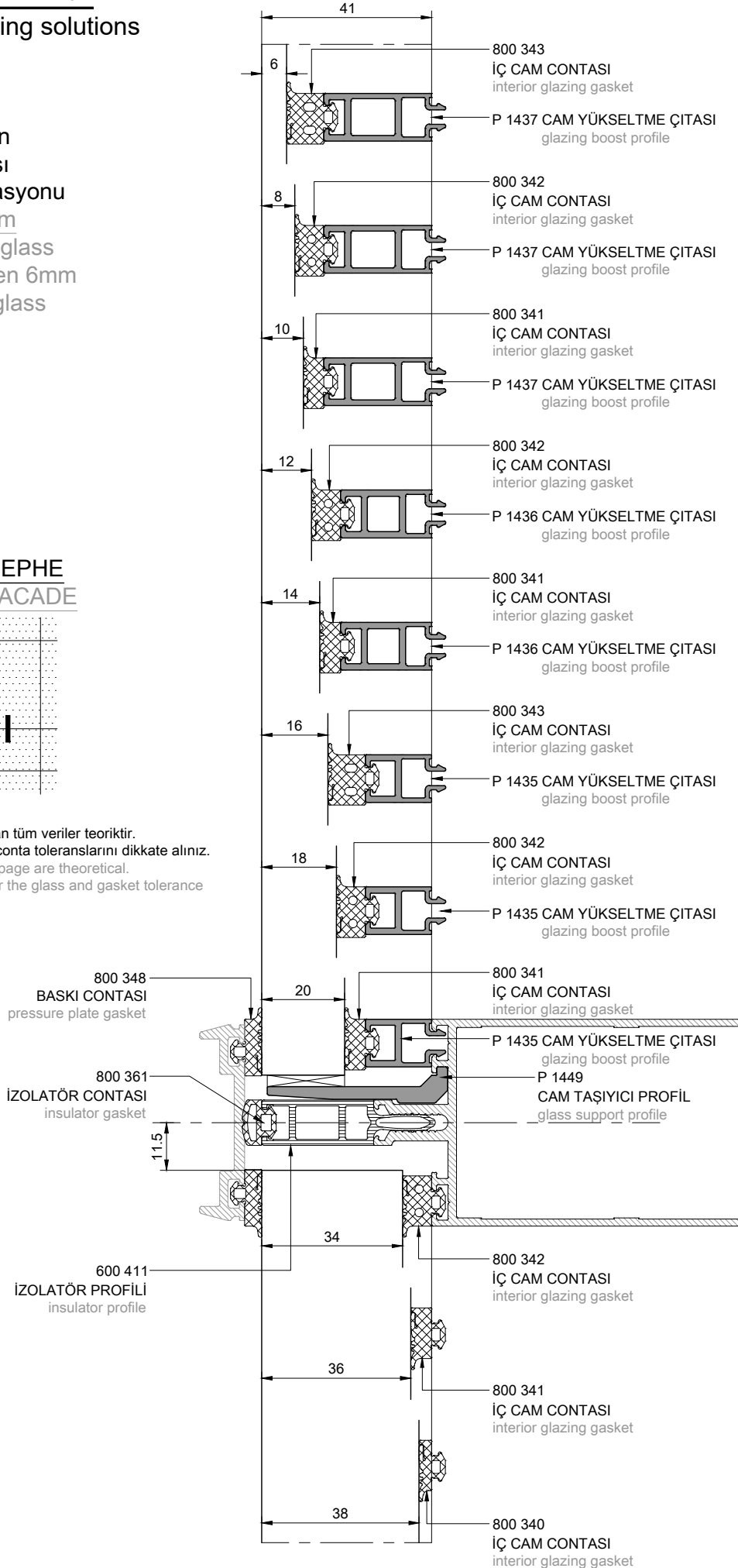

**düşey profil ile

40-42mm

kalınlıkta cam için

6mm-20mm arası

tek cam kombinasyonu

**with the mullion

for 40-42mm glass

thickness between 6mm

to 20mm single glass

combinations

KAPAKLI CEPHE CAPPED FACADE

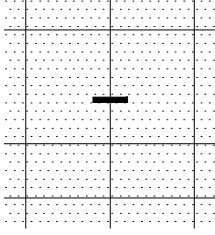

Sayfada bulunan tüm veriler teoriktir.
Lütfen cam ve conta toleranslarını dikkate alınız.
All data on the page are theoretical.
Please consider the glass and gasket tolerance

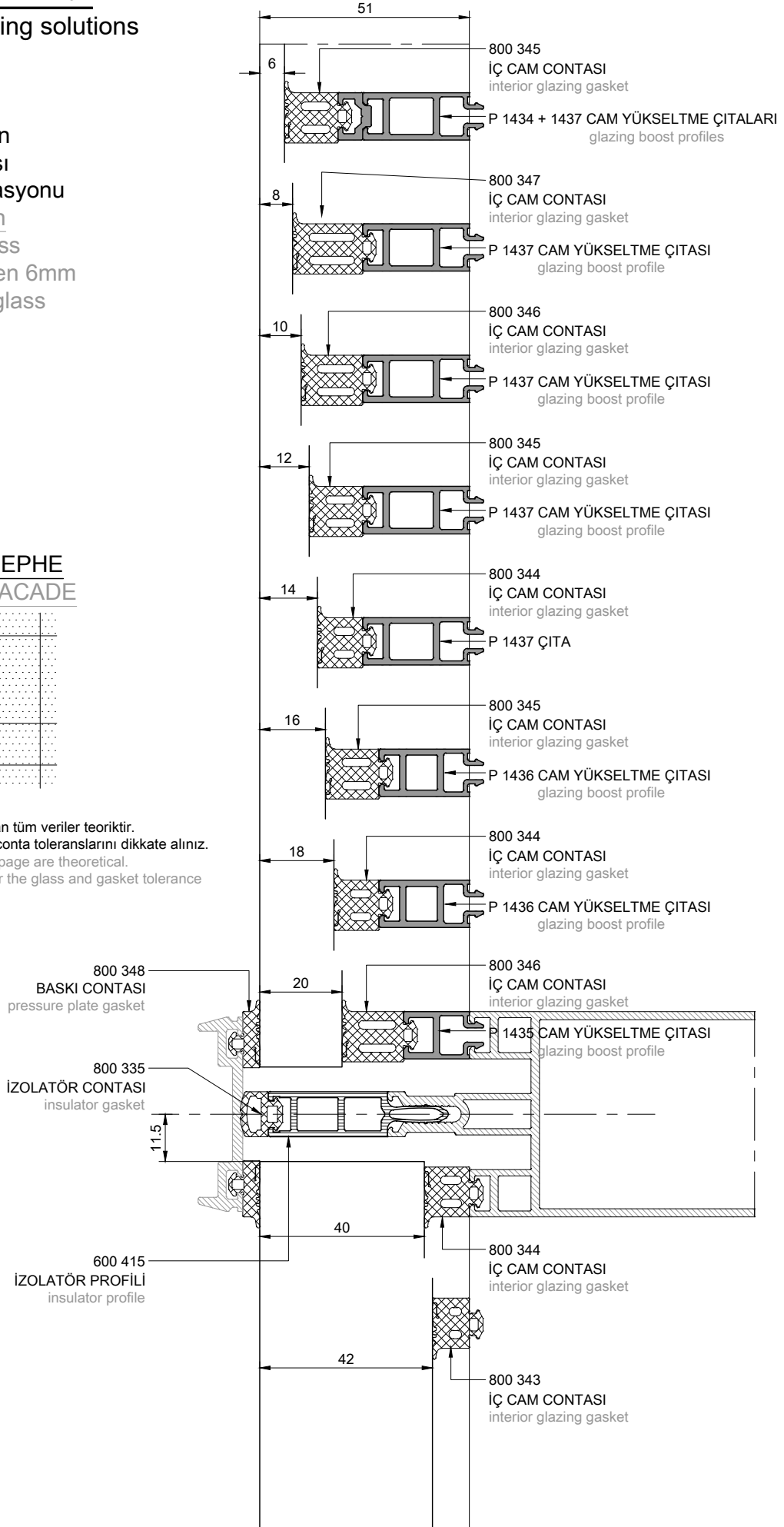

****yatay profil ile**
40-42mm
kalınlıkta cam için
6mm-20mm arası
tek cam kombinasyonu
****with the transom**
for 40-42mm glass
thickness between 6mm
to 20mm single glass
combinations

KAPAKLI CEPHE CAPPED FACADE

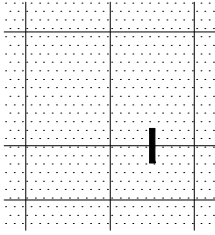

Sayfada bulunan tüm veriler teoriktir.
Lütfen cam ve conta toleranslarını dikkate alınız.
All data on the page are theoretical.
Please consider the glass and gasket tolerance

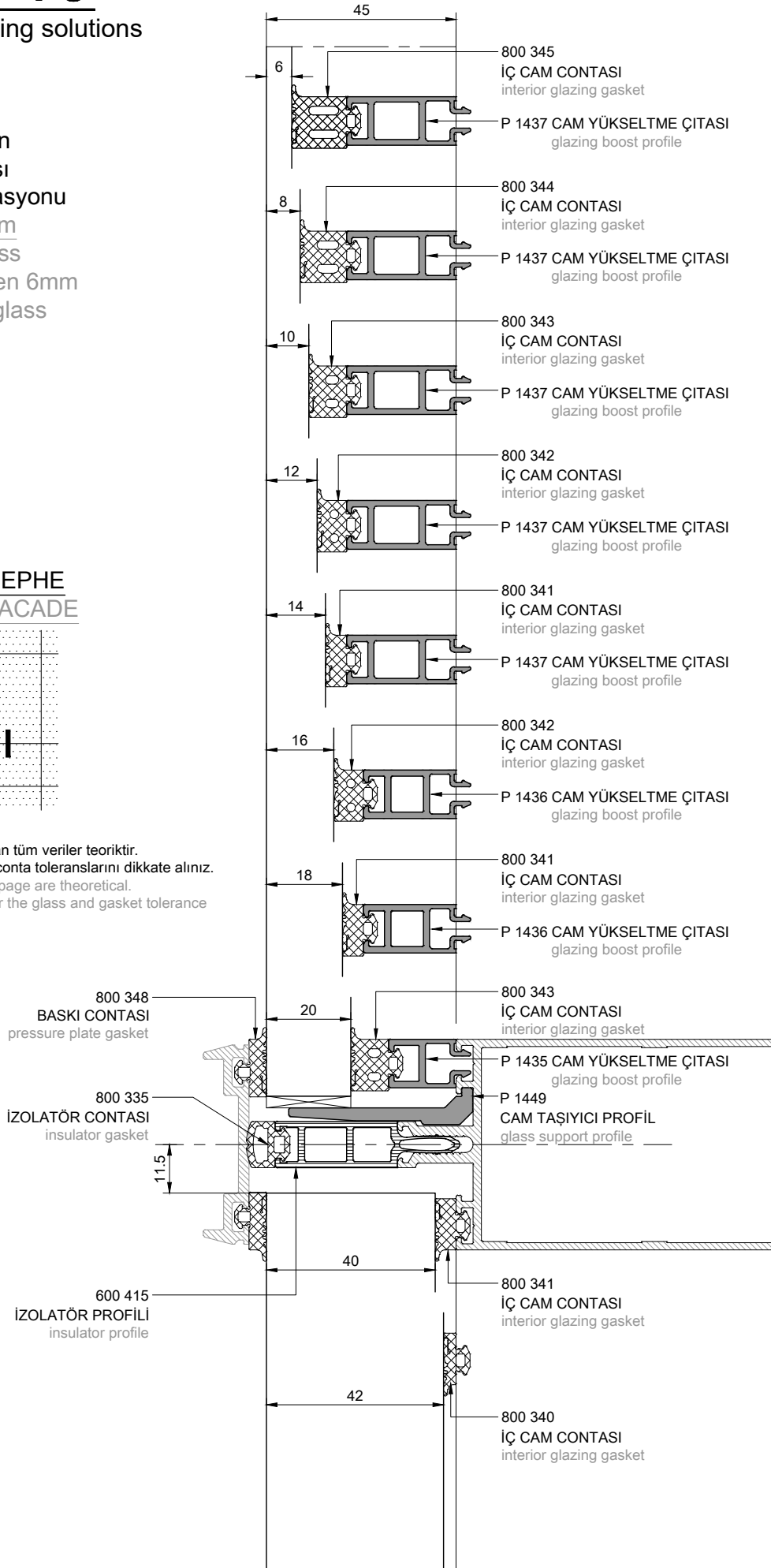

vasistas pencere
birleşimi ile
22-24-26mm kalınlıkta
cam kombinasyonu
combinations for
22-24-26mm glass
thickness between top
hung window connection

KAPAKLI CEPHE CAPPED FAÇADE

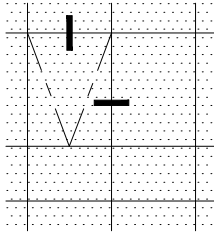

Sayfada bulunan tüm veriler teoriktir.
Lütfen cam ve conta toleranslarını dikkate alınız.
All data on the page are theoretical.
Please consider the glass and gasket tolerance

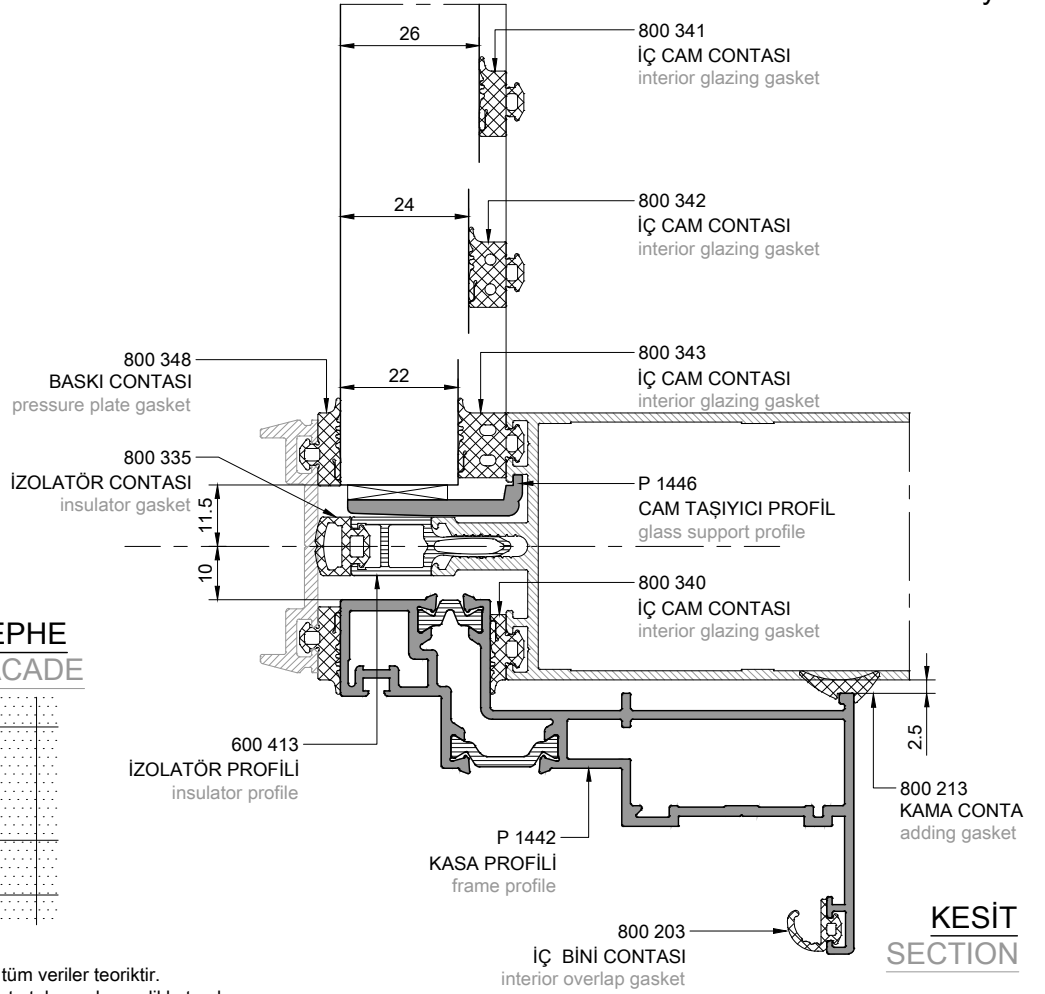

KESİT SECTION

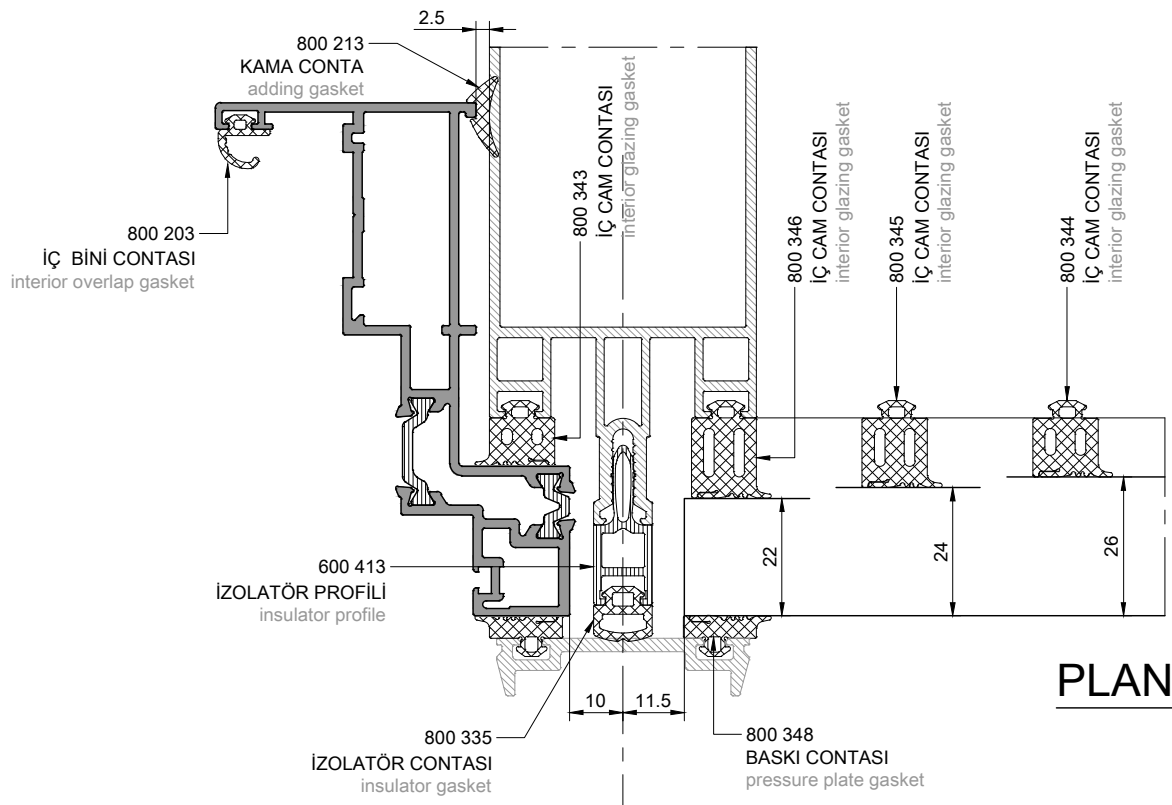

PLAN

vasistas pencere
birleşimi ile
28-30-32mm kalınlıkta
cam kombinasyonu
combinations for
28-30-32mm glass
thickness between top
hung window connection

KAPAKLI CEPHE CAPPED FAÇADE

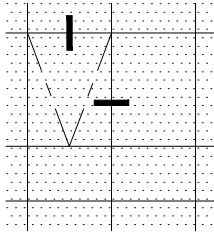

Sayfada bulunan tüm veriler teoriktir.
Lütfen cam ve conta toleranslarını dikkate alınız.
All data on the page are theoretical.
Please consider the glass and gasket tolerance

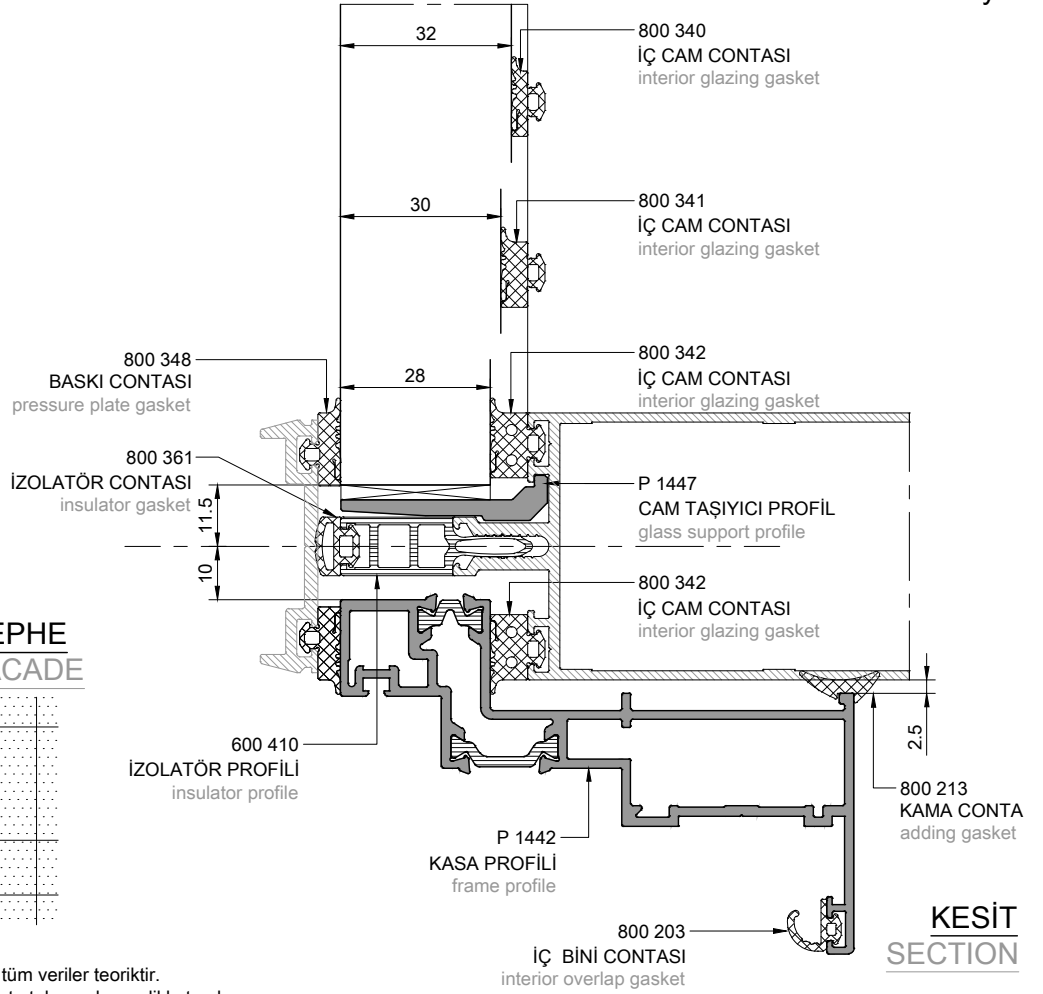

KESİT SECTION

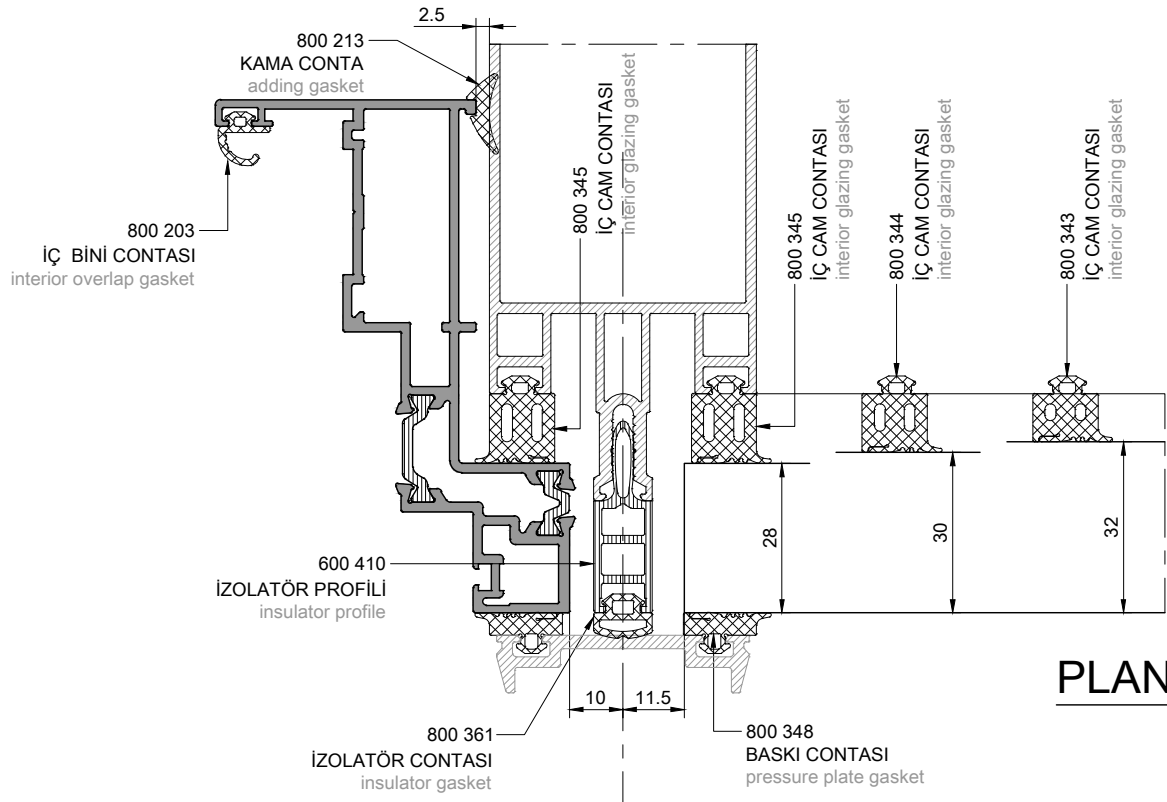

PLAN

vasistas pencere
birleşimi ile
34-36-38mm kalınlıkta
cam kombinasyonu
combinations for
34-36-38mm glass
thickness between top
hung window connection

KAPAKLI CEPHE CAPPED FAÇADE

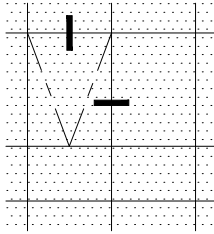

Sayfada bulunan tüm veriler teoriktir.
Lütfen cam ve conta toleranslarını dikkate alınız.
All data on the page are theoretical.
Please consider the glass and gasket tolerance

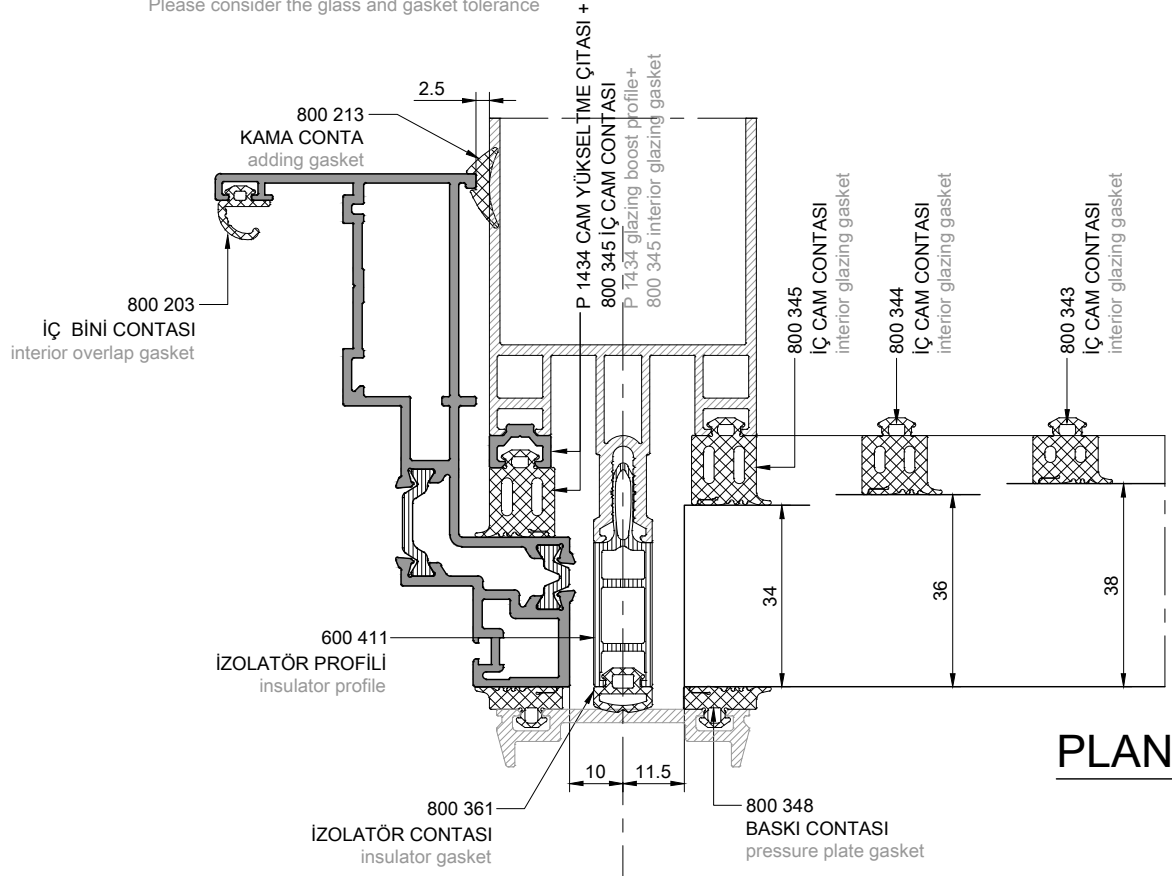
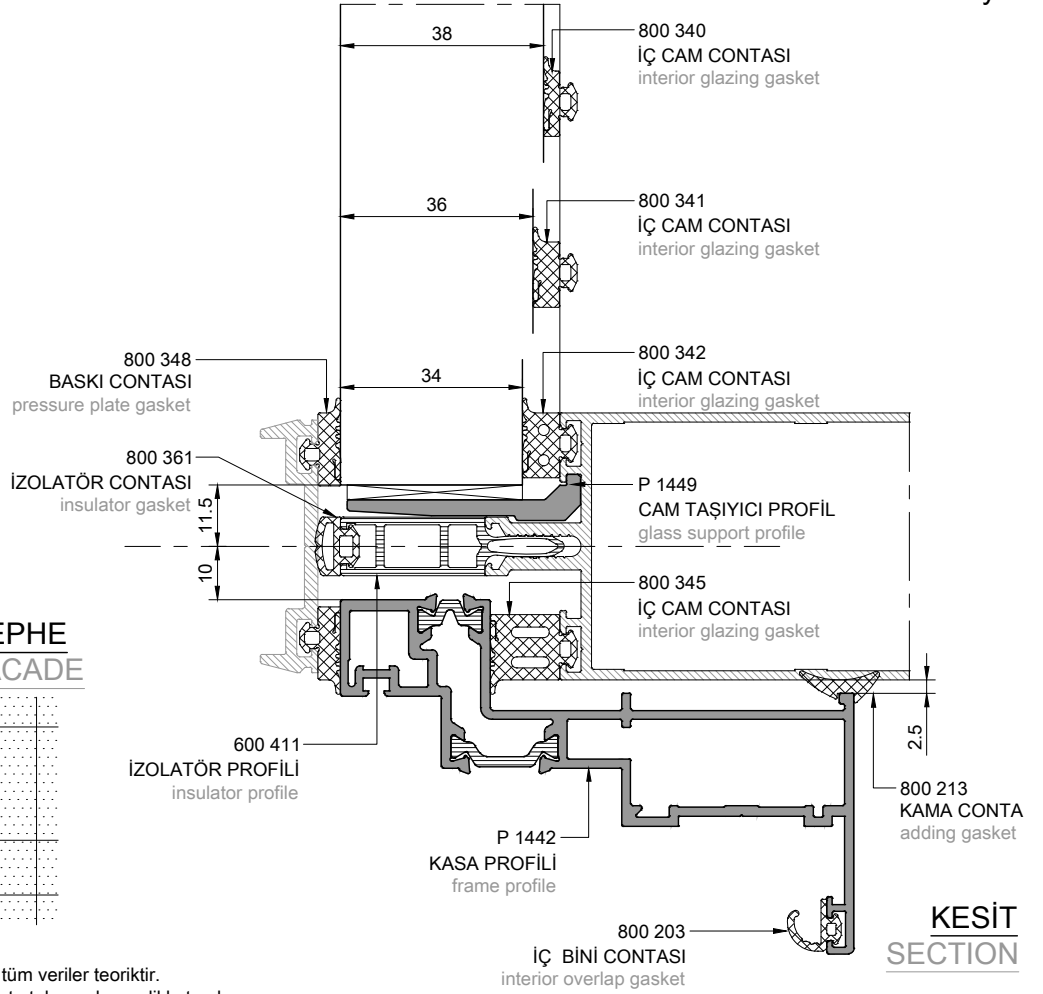

vasistas pencere
birleşimi ile
40-42mm kalınlıkta
cam kombinasyonu
combinations for
40-42mm glass
thickness between top
hung window connection

KAPAKLI CEPHE CAPPED FAÇADE

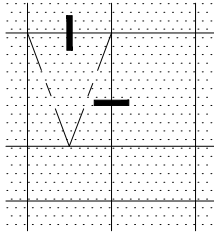

Sayfada bulunan tüm veriler teoriktir.
Lütfen cam ve conta toleranslarını dikkate alınız.
All data on the page are theoretical.
Please consider the glass and gasket tolerance

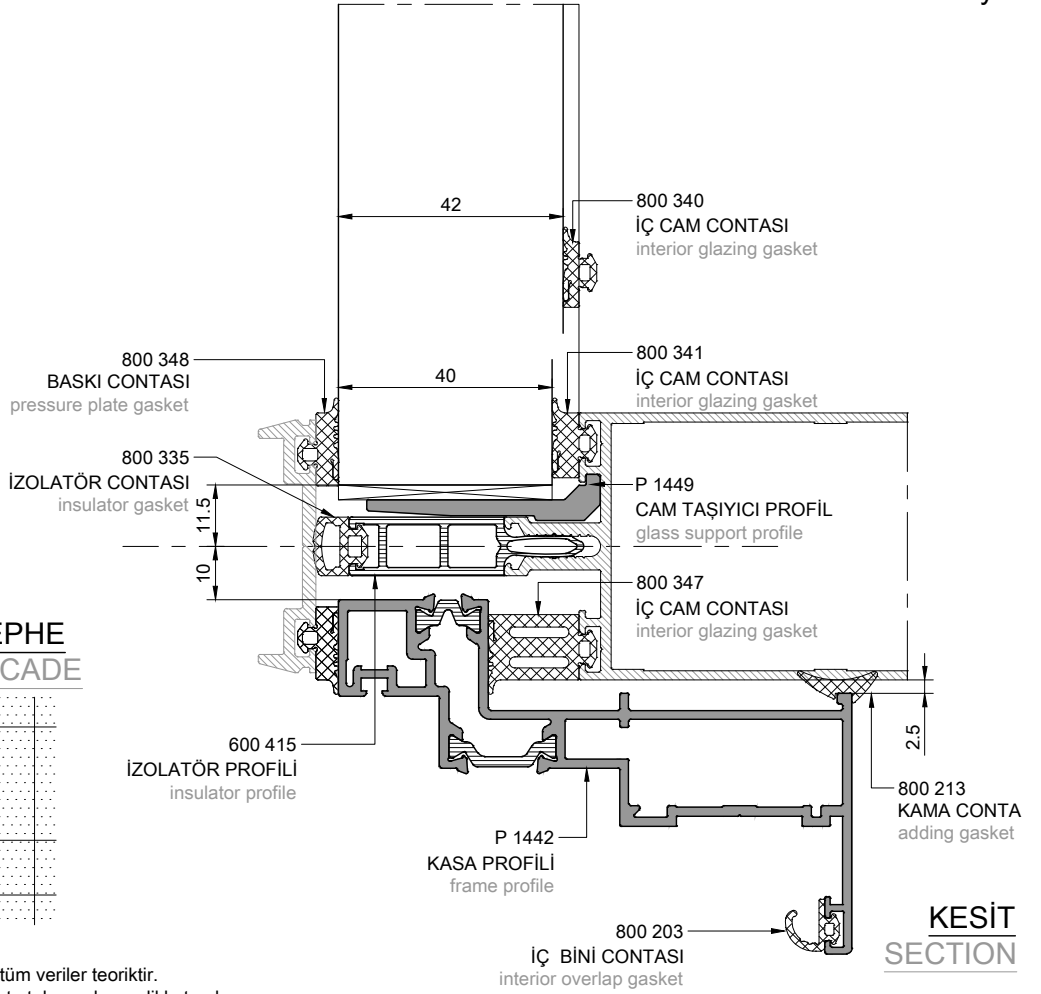

KESİT SECTION

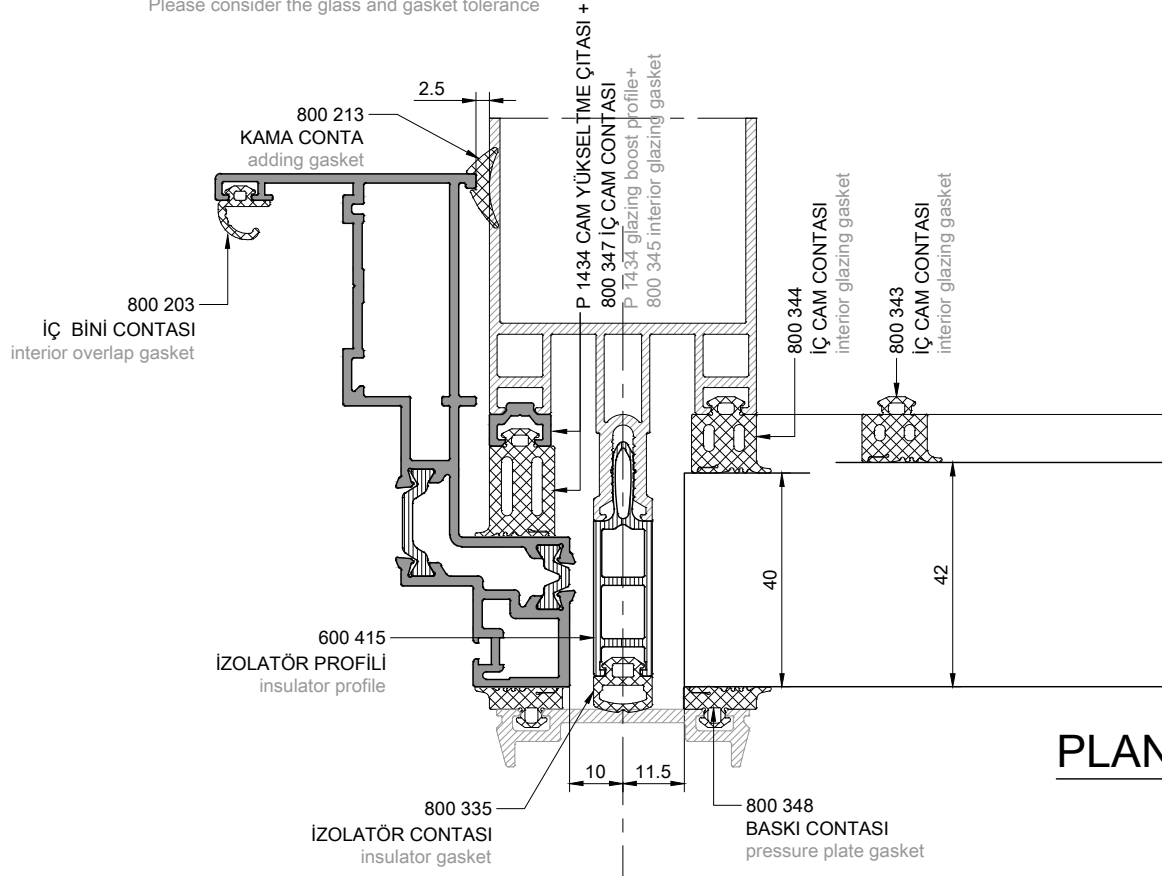

PLAN

****dış cam 6mm**

olması durumuna göre
20mm - 34mm

kalınlıkta cam için
kanat cam kombinasyonu

****outside glass 6mm**

depending on the situation
combination for 20mm-34mm
sash glass

KAPAKLI CEPHE CAPPED FACADE

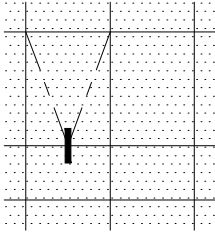

Sayfada bulunan tüm veriler teoriktir.
Lütfen cam ve conta toleranslarını dikkate alınız.
All data on the page are theoretical.
Please consider the glass and gasket tolerance

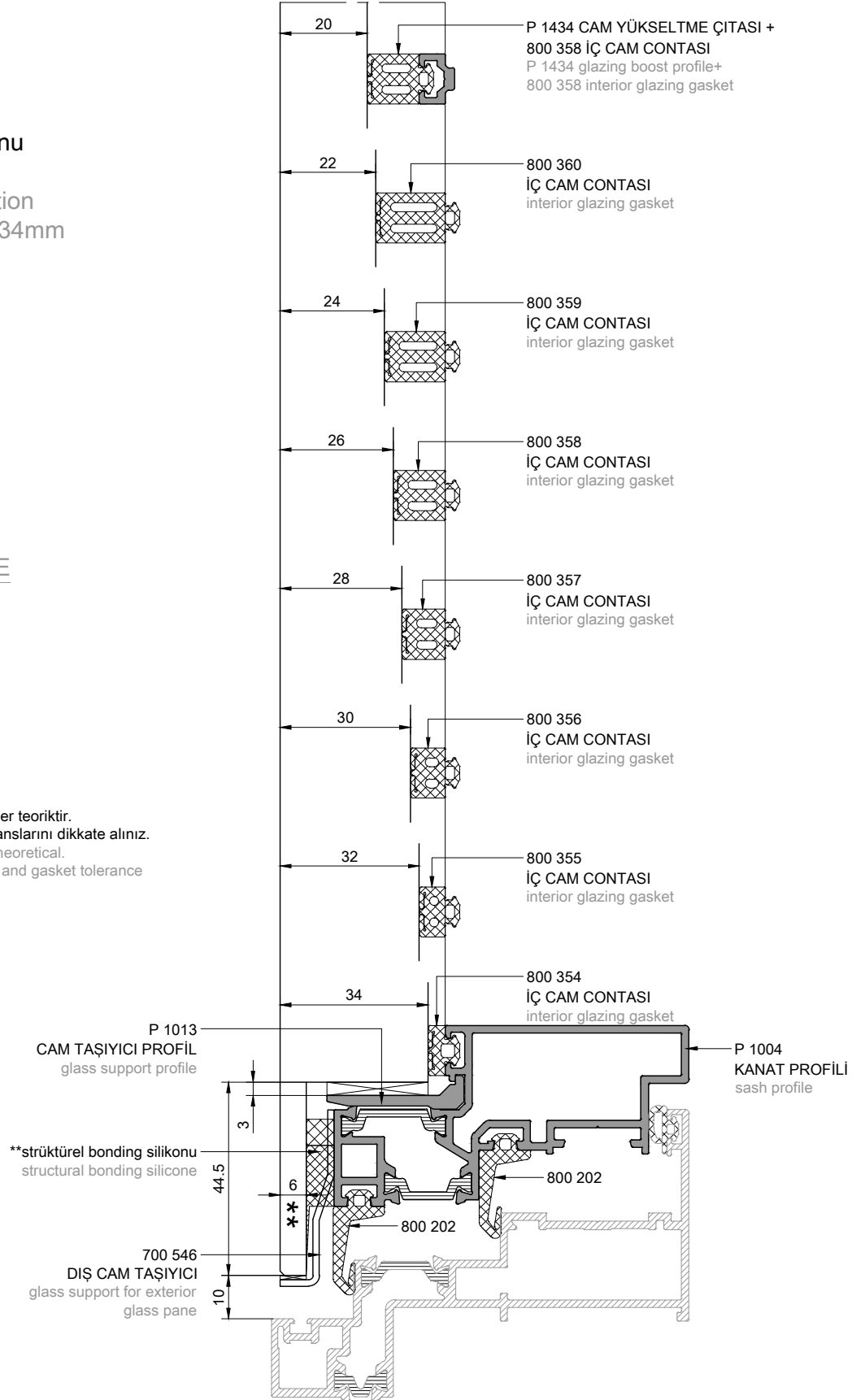

Strüktürel bonding silikonu özellikleri ve uygun malzeme seçimi, gerekli hesapların yapılması sorumluluğu ve garantisi uygulamacıya ve strüktürel bonding ve camlama yüklenicisine aittir. Toz boyalı ve eloksallı alüminyum profile camların yapılandırılması ve uygulaması ile ilgili uygulama ve malzeme konusunda garanti alınması, sorumluluğu uygulamacıya aittir.

Strüktürel bonding ile ilgili tüm testler uygulama firması tarafından yaptırılmalı ve test raporları KLEIDCO'ya gönderilmelidir.

Structural bonding silicone properties and appropriate material selection, making necessary calculations, responsibility and warranty belong to the applicator and the structural bonding and glazing contractor.

All bonding procedures, bonding material choice and bonding quality management are under responsibility of Bonding Company.

All tests related to structural bonding be made by the Implementation company and the test reports should be send to KLEIDCO.

**dış cam 8mm

olması durumuna göre
20mm - 34mm

kalınlıkta cam için
kanat cam kombinasyonu

**outside glass 8mm

depending on the situation
combination for 20mm-34mm
sash glass

KAPAKLI CEPHE CAPPED FACADE

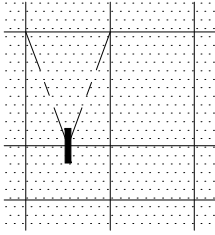

Sayfada bulunan tüm veriler teoriktir.
Lütfen cam ve conta toleranslarını dikkate alınız.
All data on the page are theoretical.
Please consider the glass and gasket tolerance

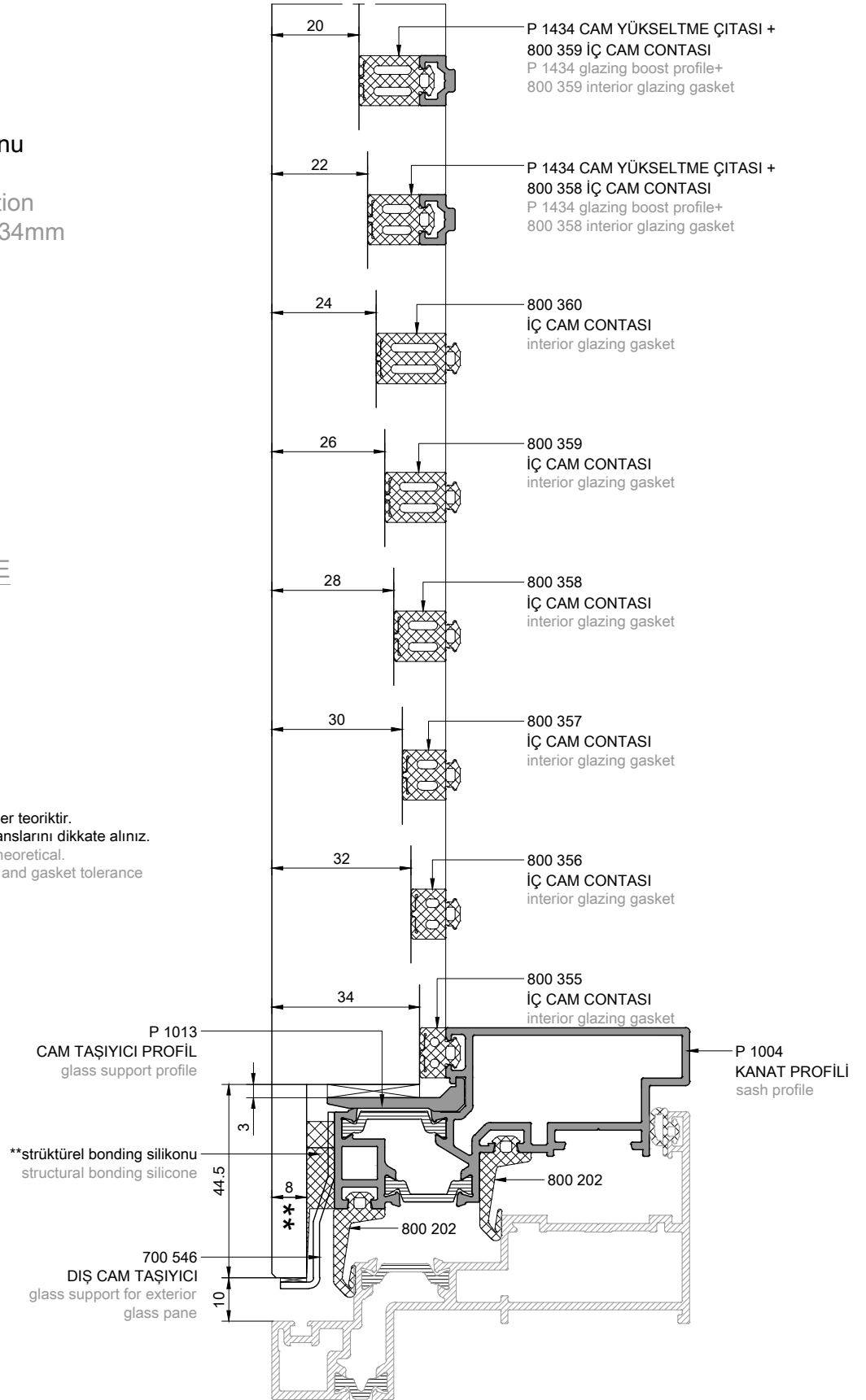

**

Strüktürel bonding silikonu özellikleri ve uygun malzeme seçimi,gerekli hesapların yapılması sorumluluğu ve garantisi uygulamacıya ve strüktürel bonding ve camlama yüklenicisine aittir. Toz boyalı ve eloksallı alüminyum profile camların yapılandırılması ve uygulaması ile ilgili uygulama ve malzeme konusunda garanti alınması,sorumluluğu uygulamacıya aittir.

Strüktürel bonding ile ilgili tüm testler uygulama firması tarafından yaptırılmalı ve test raporları KLEIDCO'ya gönderilmelidir.

Structural bonding silicone properties and appropriate material selection ,making necessary calculations, responsibility and warranty belong to the applicator and the structural bonding and glazing contractor.

All bonding procedures, bonding material choice and bonding quality management are under responsibility of Bonding Company.

All tests related to structural bonding be made by the Implementation company and the test reports should be send to KLEIDCO.

**dış cam 6mm

olması durumuna göre
36mm - 42mm

kalınlıkta cam için

kanat cam kombinasyonu

**outside glass 6mm

depending on the situation
combination for 36mm-42mm
sash glass

KAPAKLI CEPHE CAPPED FACADE

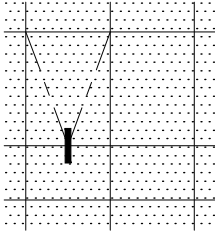

Sayfada bulunan tüm veriler teoriktir.
Lütfen cam ve conta toleranslarını dikkate alınız.
All data on the page are theoretical.
Please consider the glass and gasket tolerance

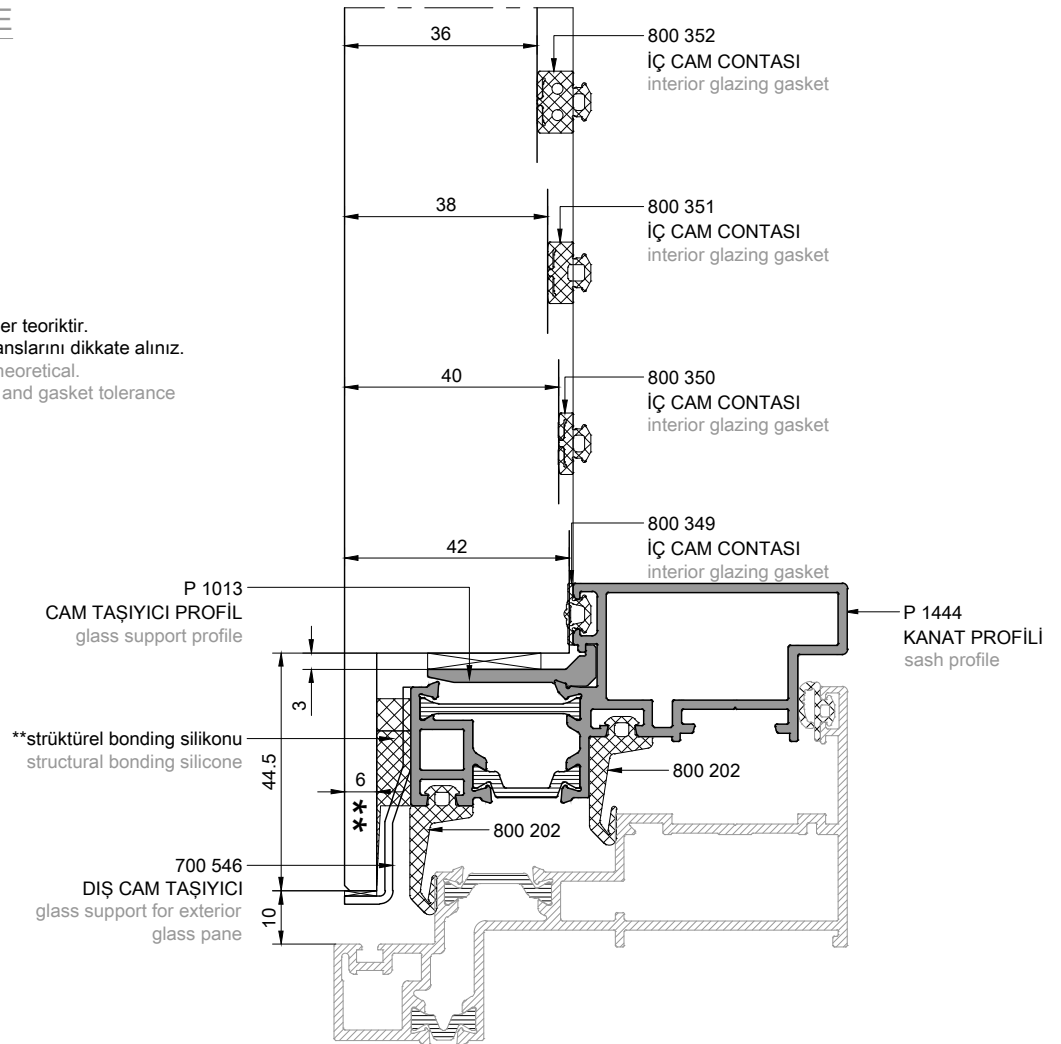

**

Strüktürel bonding silikonu özellikleri ve uygun malzeme seçimi,gerekli hesapların yapılması sorumluluğu ve garantisi uygulamacıya ve strüktürel bonding ve camlama yüklenicisine aittir. Toz boyalı ve eloksallı alüminyum profile camların yapılandırılması ve uygulaması ile ilgili uygulama ve malzeme konusunda garanti alınması,sorumluluğu uygulamacıya aittir.

Strüktürel bonding ile ilgili tüm testler uygulama firması tarafından yaptırılmalı ve test raporları KLEIDCO'ya gönderilmelidir.

Structural bonding silicone properties and appropriate material selection ,making necessary calculations, responsibility and warranty belong to the applicator and the structural bonding and glazing contractor.

All bonding procedures, bonding material choice and bonding quality management are under responsibility of Bonding Company.

All tests related to structural bonding be made by the Implementation company and the test reports should be send to KLEIDCO.

**dış cam 8mm

olması durumuna göre
36mm - 42mm

kalınlıkta cam için

kanat cam kombinasyonu

**outside glass 8mm

depending on the situation
combination for 36mm-42mm
sash glass

KAPAKLI CEPHE CAPPED FACADE

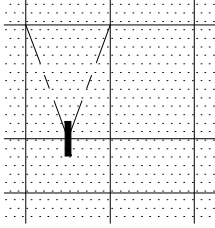

Sayfada bulunan tüm veriler teoriktir.
Lütfen cam ve conta toleranslarını dikkate alınız.
All data on the page are theoretical.
Please consider the glass and gasket tolerance

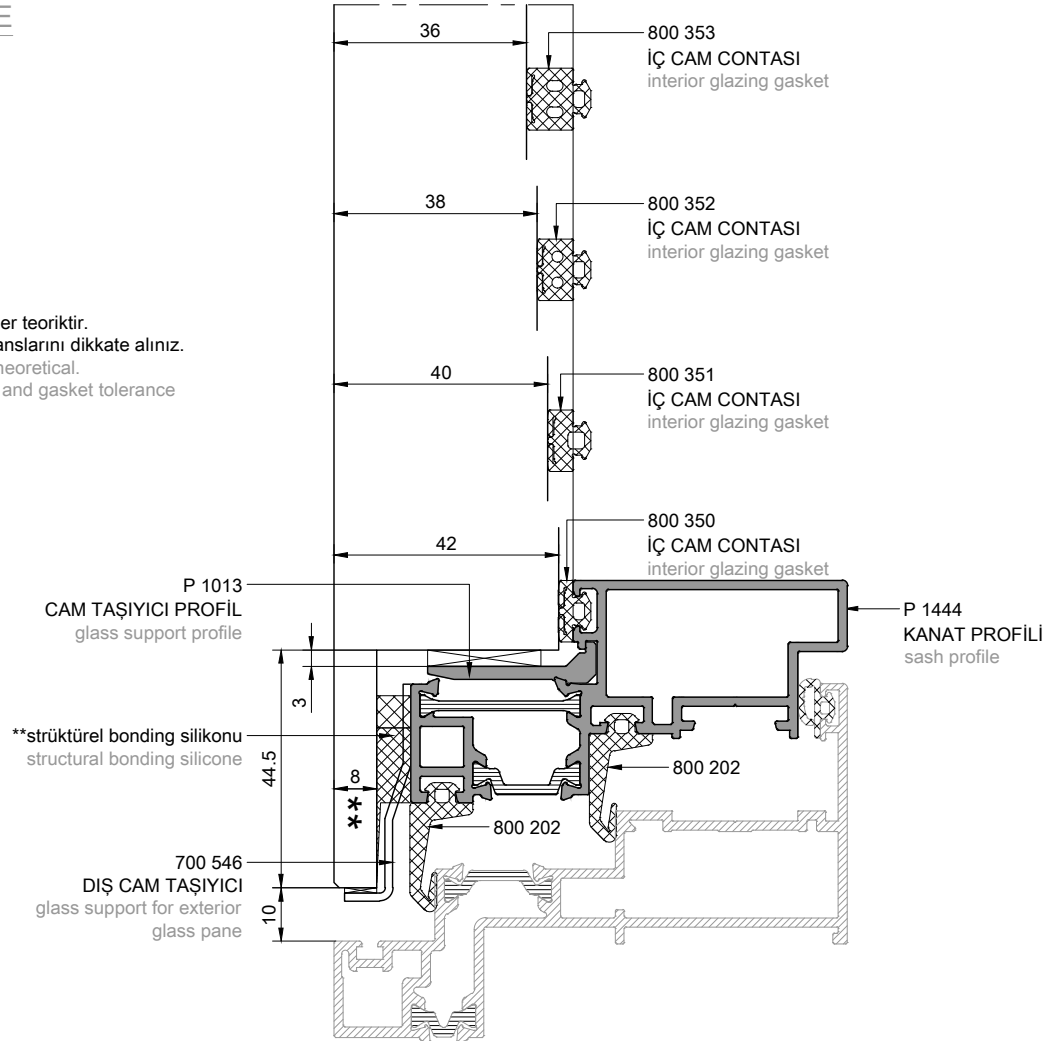

**

Strüktürel bonding silikonu özellikleri ve uygun malzeme seçimi,gerekli hesapların yapılması sorumluluğu ve garantisi uygulamacıya ve strüktürel bonding ve camlama yüklenicisine aittir. Toz boyalı ve eloksallı alüminyum profile camların yapıştirılması ve uygulaması ile ilgili uygulama ve malzeme konusunda garanti alınması,sorumluluğu uygulamacıya aittir.

Strüktürel bonding ile ilgili tüm testler uygulama firması tarafından yaptırılmalı ve test raporları KLEIDCO'ya gönderilmelidir.

Structural bonding silicone properties and appropriate material selection ,making necessary calculations,responsibility and warranty belong to the applicator and the structural bonding and glazing contractor.

All bonding procedures, bonding material choice and bonding quality management are under responsibility of Bonding Company.

All tests related to structural bonding be made by the Implementation company and the test reports should be send to KLEIDCO.

FS 50

STICK GİYDİRME CEPHE SİSTEMİ

STICK CURTAIN WALL SYSTEM

SİLİKON CEPHE
(CAM İÇİ LOKAL U KANALLI)
CAM KOMBİNASYONLARI
SILICONE FACADE
(INSIDE GLASS U CHANNEL)
GLASS COMBINATIONS

****dış cam 6mm**
olması durumuna göre
28-30-32mm
kalınlıkta camlar için kombinasyon
****outside glass 6mm**
depending on the situation
combination for 28-30-32mm glass

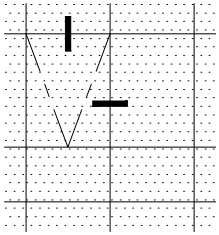
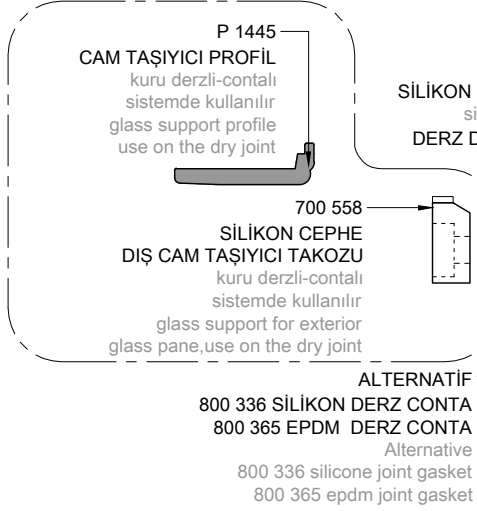

SİLİKON CEPHE SILICONE FACADE

Sayfada bulunan tüm veriler teoriktir.
Lütfen cam ve conta toleranslarını dikkate alınız.
All data on the page are theoretical.
Please consider the glass and gasket tolerance

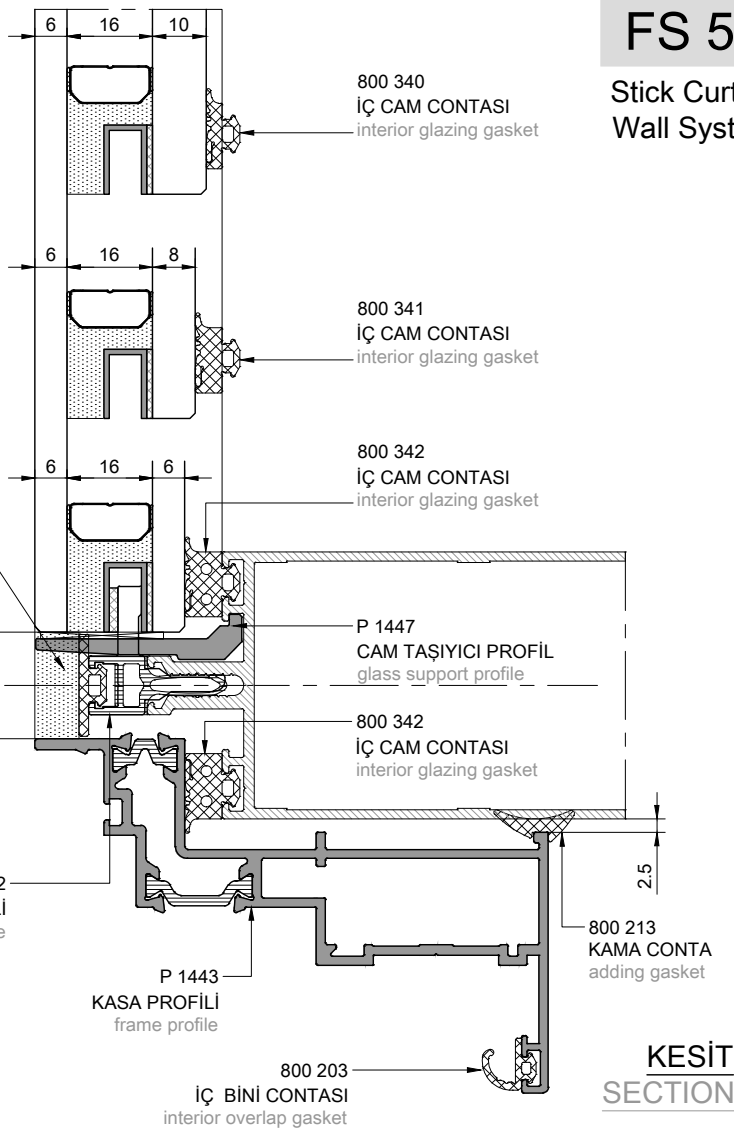

KESİT SECTION

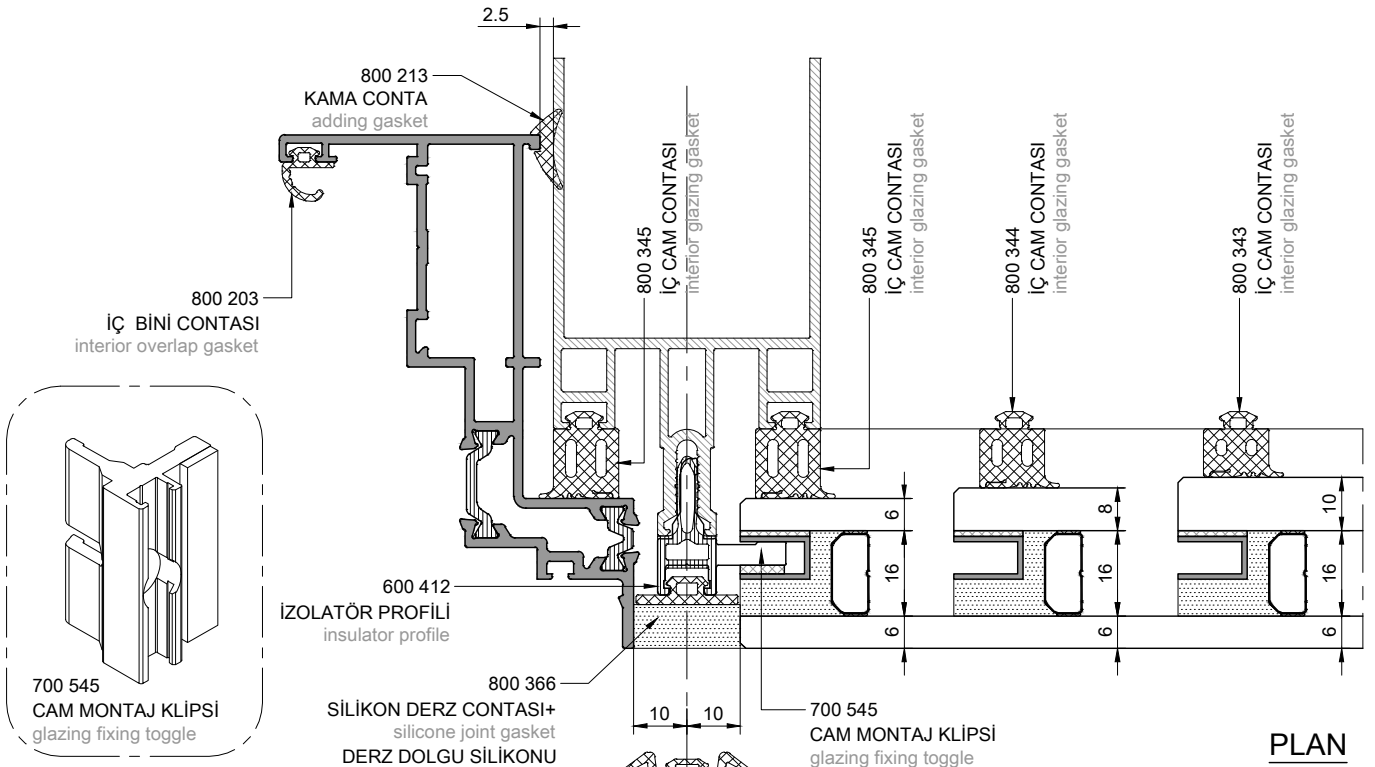

PLAN

****dış cam 8mm**
olması durumuna göre
30-32-34mm
kalınlıkta camlar için kombinasyon
****outside glass 8mm**
depending on the situation
combination for 30-32-34mm glass

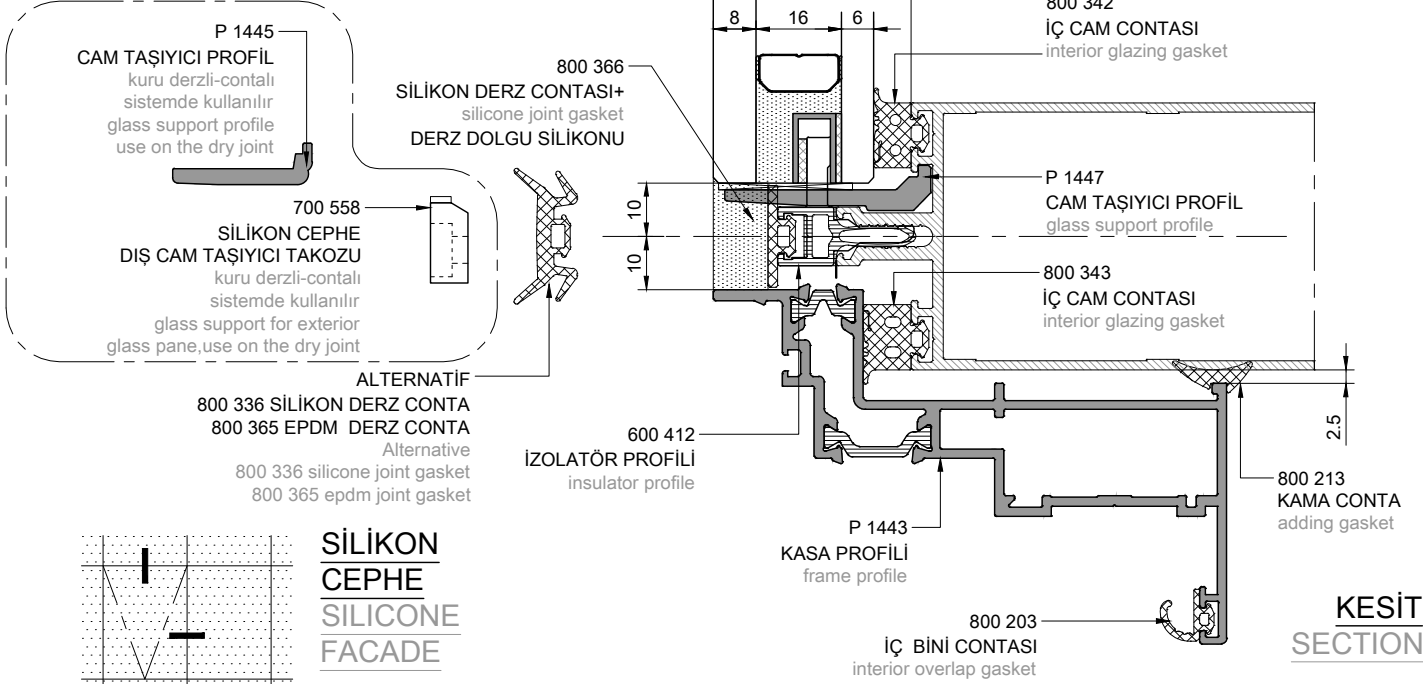

**KESİT
SECTION**

SİLİKON CEPHE SİLİKON FACADE

Sayfada bulunan tüm veriler teoriktir.
 Lütfen cam ve conta toleranslarını dikkate alınız.
 All data on the page are theoretical.
 Please consider the glass and gasket tolerance

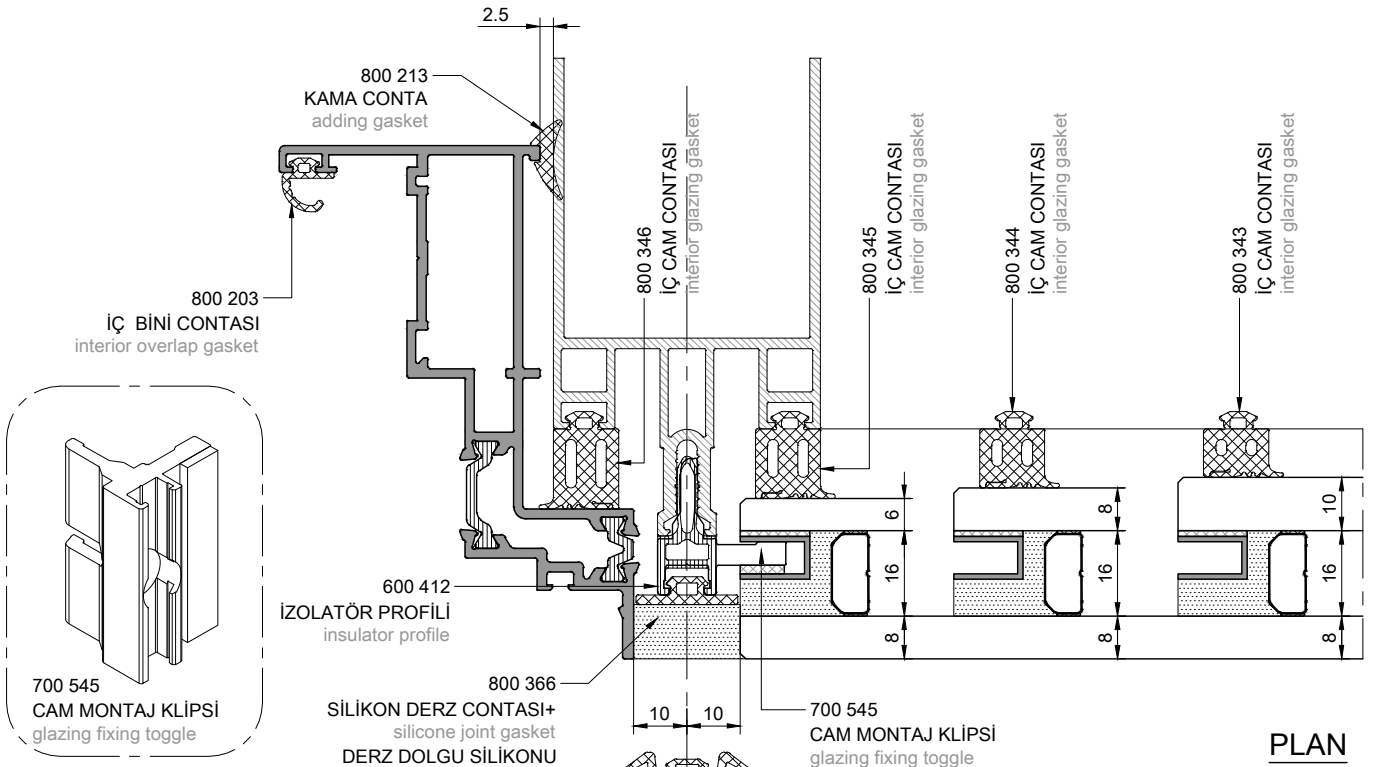

PLAN

****diş cam 6mm**
olması durumuna göre
34-36-38mm
kalınlıkta camlar için kombinasyon
****outside glass 6mm**
depending on the situation
combination for 34-36-38mm glass

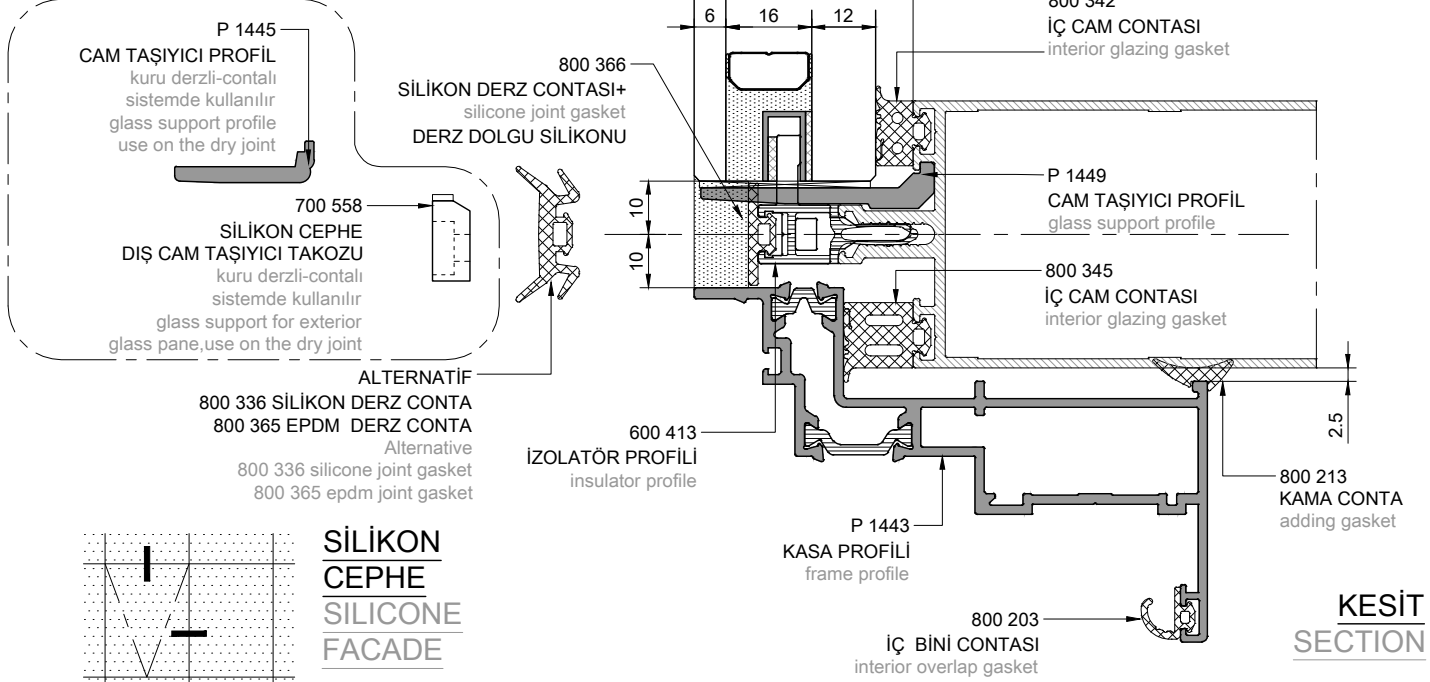

Sayfada bulunan tüm veriler teoriktir.
Lütfen cam ve conta toleranslarını dikkate alınız.
All data on the page are theoretical.
Please consider the glass and gasket tolerance

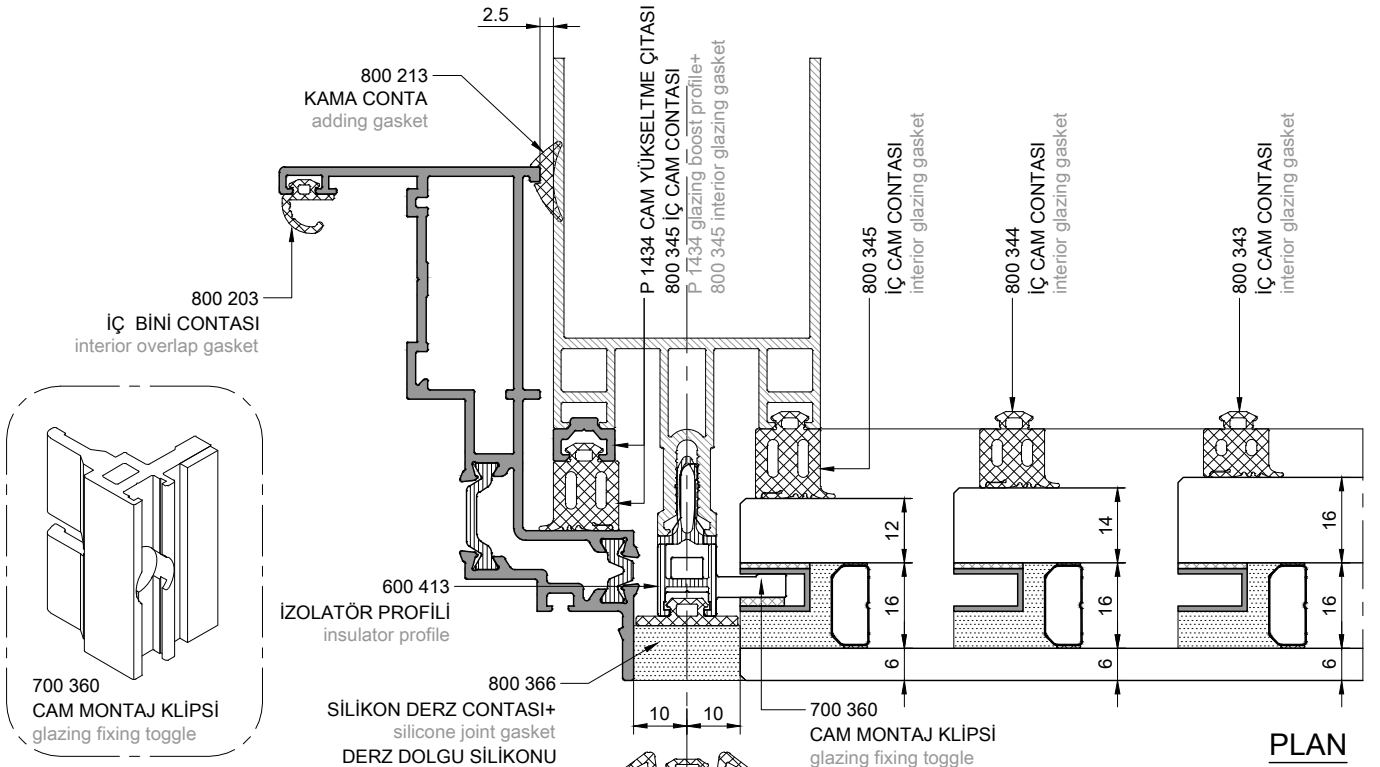

****dış cam 8mm**
olması durumuna göre
36-38-40mm
kalınlıkta camlar için kombinasyon
****outside glass 8mm**
depending on the situation
combination for 36-38-40mm glass

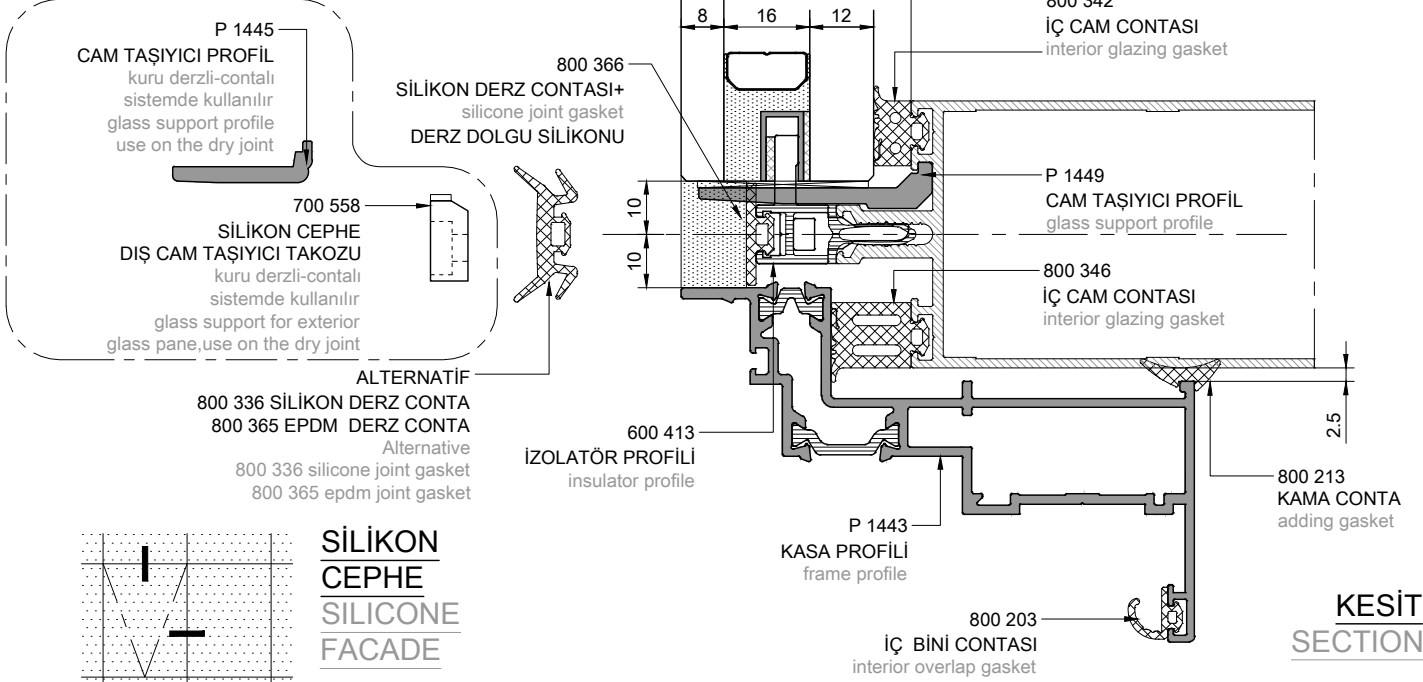

Sayfada bulunan tüm veriler teoriktir.
Lütfen cam ve conta toleranslarını dikkate alınız.
All data on the page are theoretical.
Please consider the glass and gasket tolerance

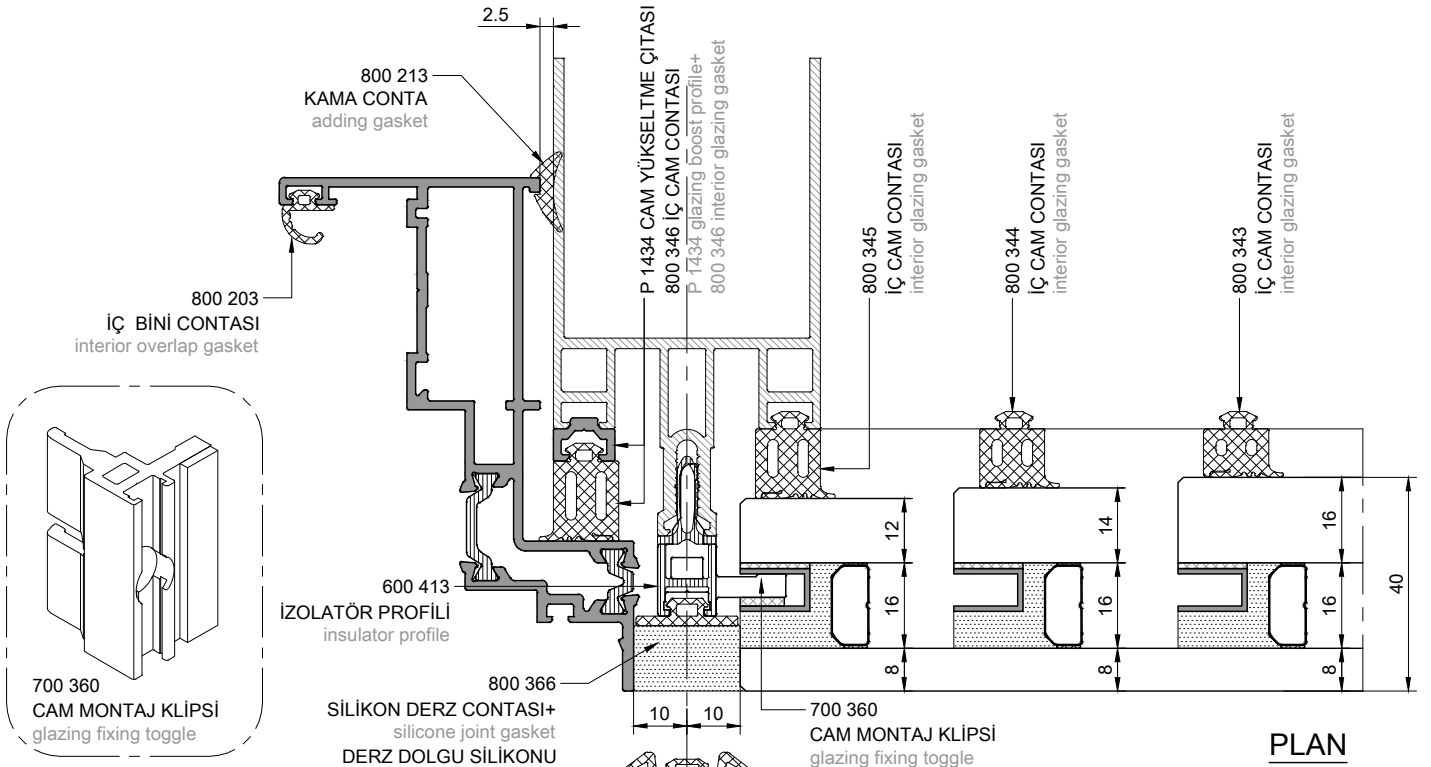

**dış cam 6mm

olması durumuna göre
20mm - 34mm

kalınlıkta cam için
kanat cam kombinasyonu

**outside glass 6mm

depending on the situation
combination for 20mm-34mm
sash glass

SİLİKON CEPHE SILICONE FACADE

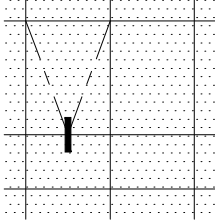

Sayfada bulunan tüm veriler teoriktir.
Lütfen cam ve conta toleranslarını dikkate alınız.
All data on the page are theoretical.
Please consider the glass and gasket tolerance

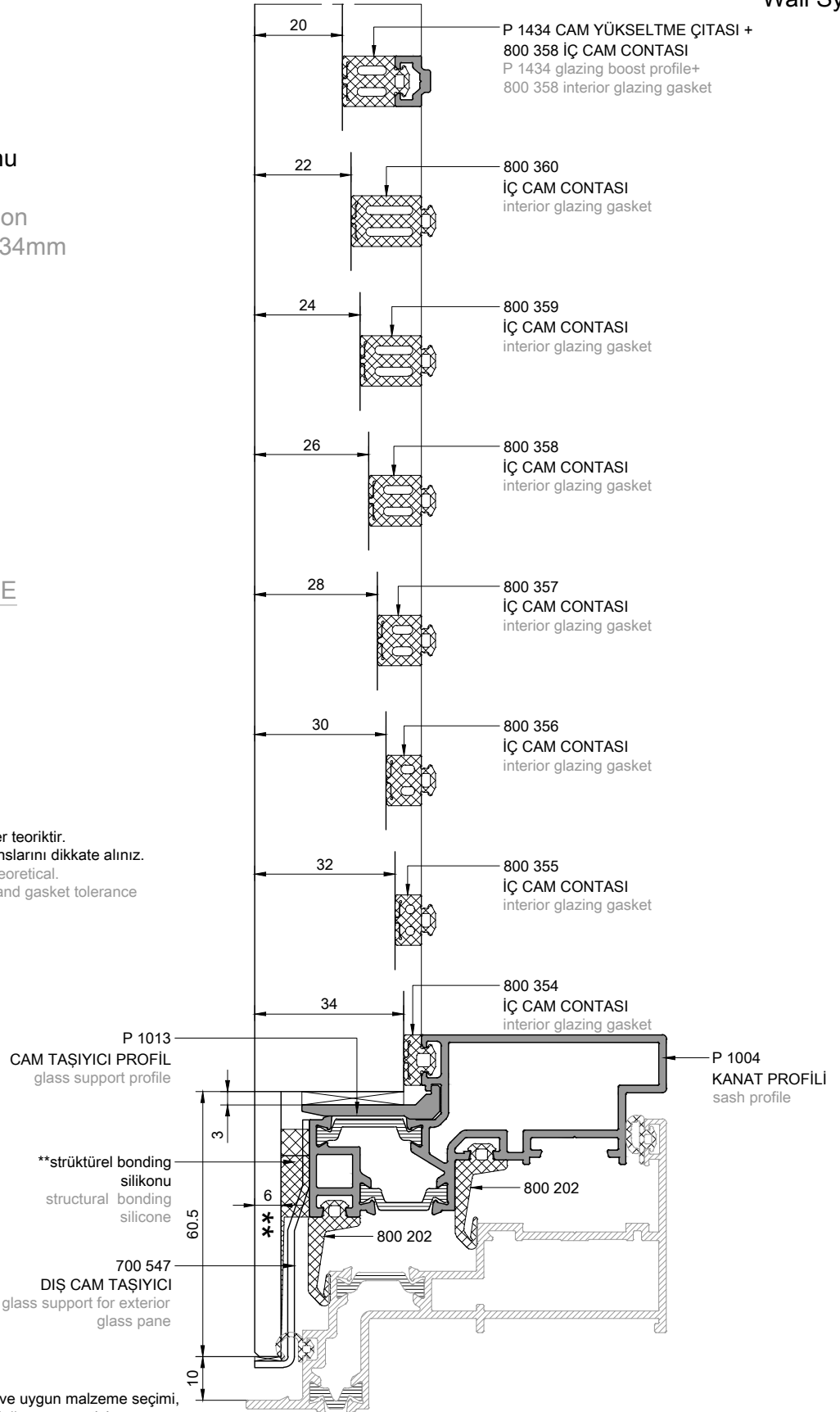

**

Strüktürel bonding silikonu özellikleri ve uygun malzeme seçimi, gerekli hesapların yapılması sorumluluğu ve garantisi uygulamacıya ve strüktürel bonding ve camlama yüklenicisine aittir. Toz boyalı ve eloksallı alüminyum profile camların yapıştırılması ve uygulaması ile ilgili uygulama ve malzeme konusunda garanti alınması, sorumluluğu uygulamacıya aittir. Strüktürel bonding ile ilgili tüm testler uygulama firması tarafından yapılmalı ve test raporları KLEIDCO'ya gönderilmelidir.

Structurol bonding silicone properties and appropriate material selection ,making necessary calculations,responsibility and warranty belong to the applicator and the structural bonding and glazing contractor. All bonding procedures, bonding material choice and bonding quality management are under responsibility of Bonding Company. All tests related to structural bonding be made by the Implementation company and the test reports should be send to KLEIDCO.

**dış cam 8mm

olması durumuna göre
20mm - 34mm

kalınlıkta cam için
kanat cam kombinasyonu

**outside glass 8mm

depending on the situation
combination for 20mm-34mm
sash glass

SİLİKON CEPHE SILICONE FACADE

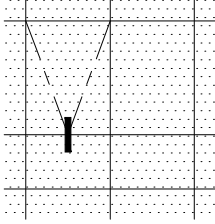

Sayfada bulunan tüm veriler teoriktir.
Lütfen cam ve conta toleranslarını dikkate alınız.
All data on the page are theoretical.
Please consider the glass and gasket tolerance

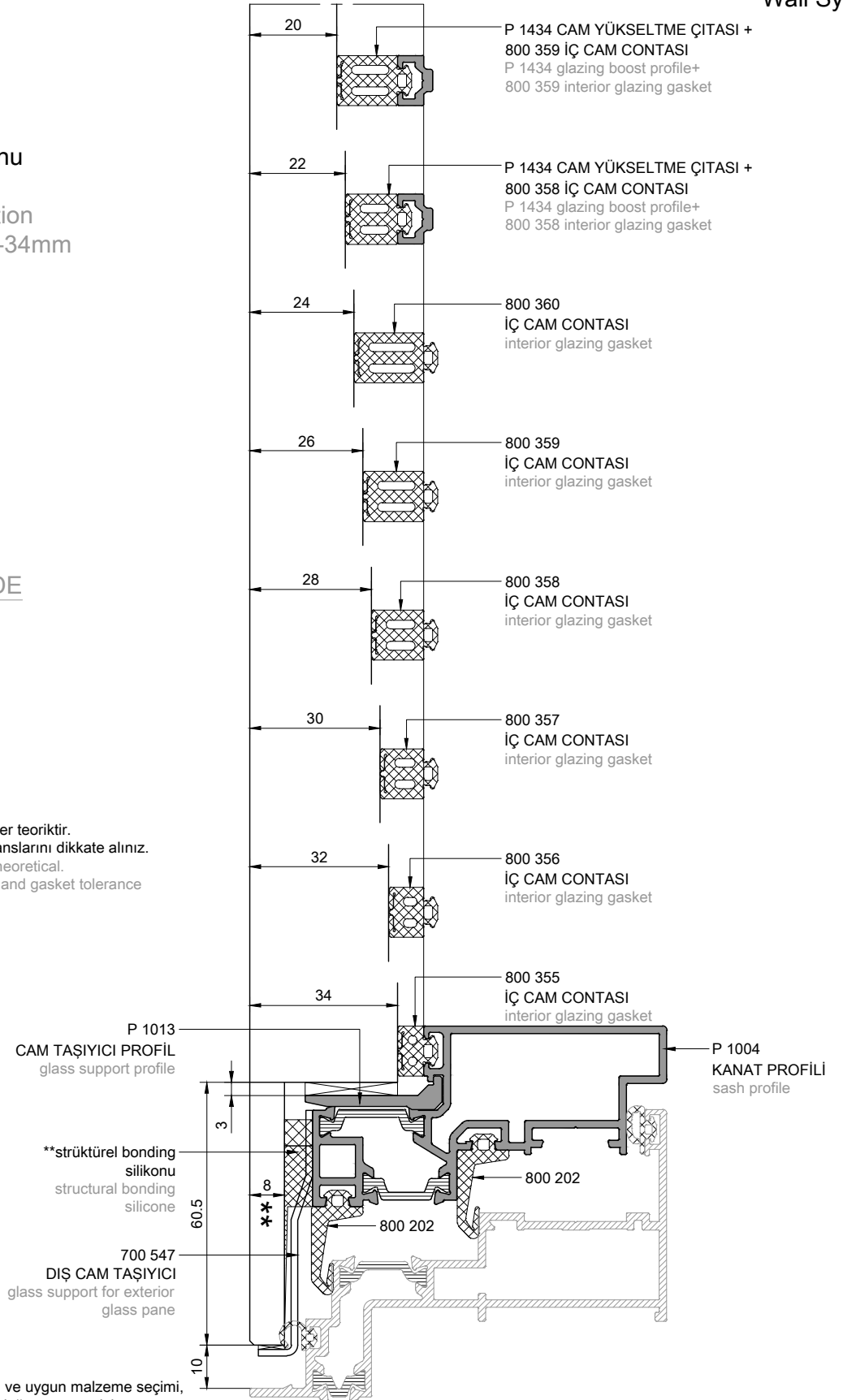

**

Strüktürel bonding silikonu özellikleri ve uygun malzeme seçimi,
gerekli hesapların yapılması sorumluluğu ve garantisi
uygulamacıya ve strüktürel bonding ve camlama yüklenicisine aittir.

Toz boyalı ve eloksallı alüminyum profile camların yapıştırılması ve
uygulaması ile ilgili uygulama ve malzeme konusunda garanti alınması, sorumluluğu uygulamacıya aittir.

Strüktürel bonding ile ilgili tüm testler uygulama firması tarafından yaptırılmalı ve test raporları KLEIDCO'ya gönderilmelidir.

Structurol bonding silicone properties and appropriate material selection ,making necessary calculations,responsibility
and warranty belong to the applicator and the structural bonding and glazing contractor.

All bonding procedures, bonding material choice and bonding quality management are under responsibility of Bonding Company.

All tests related to structural bonding be made by the Implementation company and the test reports should be send to KLEIDCO.

**dış cam 6mm

olması durumuna göre
36mm - 42mm

kalınlıkta cam için

kanat cam kombinasyonu

**outside glass 6mm

depending on the situation

combination for 36mm-42mm

sash glass

SİLİKON CEPHE SILICONE FACADE

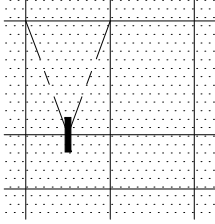

Sayfada bulunan tüm veriler teoriktir.
Lütfen cam ve conta toleranslarını dikkate alınız.
All data on the page are theoretical.
Please consider the glass and gasket tolerance

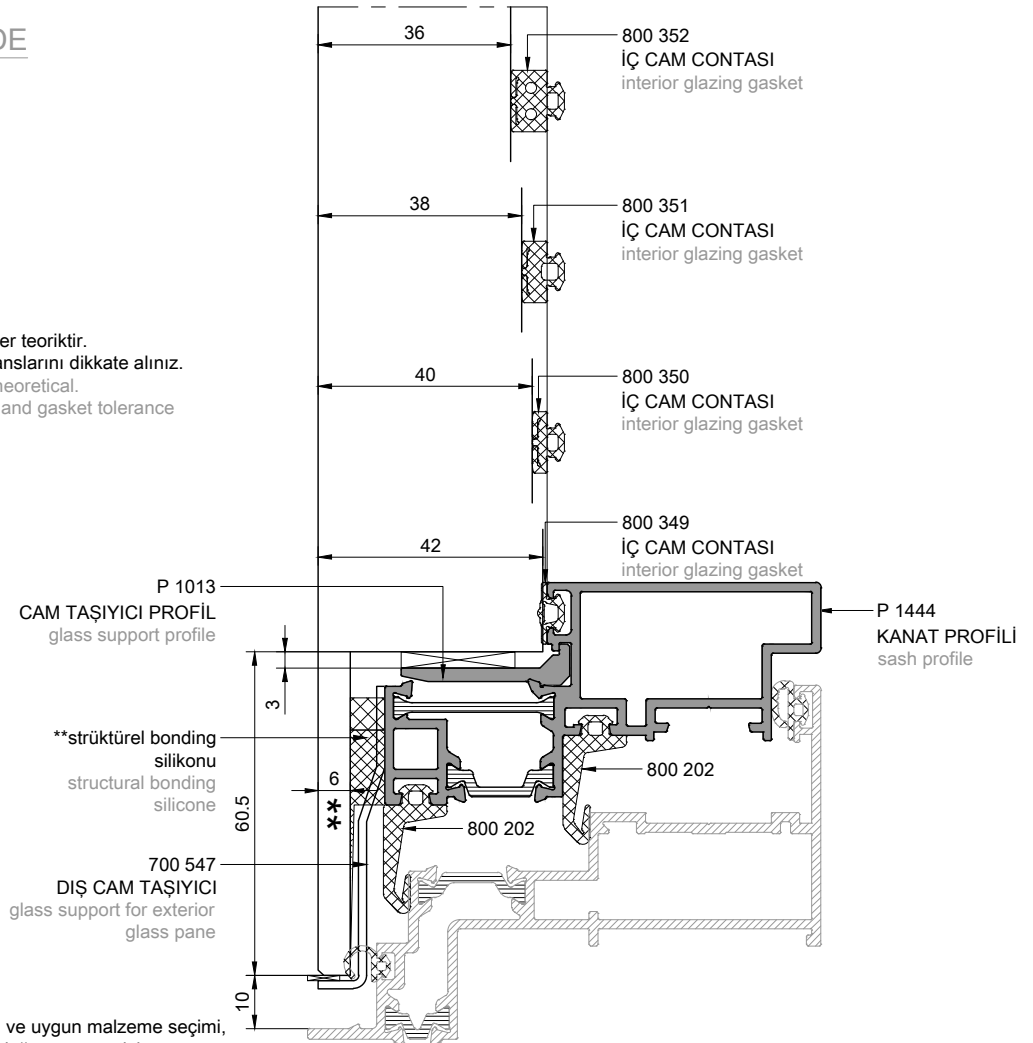

**

Strüktürel bonding silikonu özellikleri ve uygun malzeme seçimi,
gerekli hesapların yapılması sorumluluğu ve garantisi
uygulamacıya ve strüktürel bonding ve camlama yüklenicisine aittir.

Toz boyalı ve eloksallı alüminyum profile camların yapıştırılması ve

uygulaması ile ilgili uygulama ve malzeme konusunda garanti alınması, sorumluluğu uygulamacıya aittir.

Strüktürel bonding ile ilgili tüm testler uygulama firması tarafından yaptırılmalı ve test raporları KLEIDCO'ya gönderilmelidir.

Structurol bonding silicone properties and appropriate material selection ,making necessary calculations,responsibility

and warranty belong to the applicator and the structural bonding and glazing contractor.

All bonding procedures, bonding material choice and bonding quality management are under responsibility of Bonding Company.

All tests related to structural bonding be made by the Implementation company and the test reports should be send to KLEIDCO.

**dış cam 8mm

olması durumuna göre
36mm - 42mm

kalınlıkta cam için

kanat cam kombinasyonu

**outside glass 8mm

depending on the situation

combination for 36mm-42mm

sash glass

SİLİKON CEPHE SILICONE FACADE

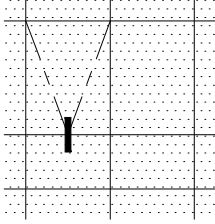

Sayfada bulunan tüm veriler teoriktir.
Lütfen cam ve conta toleranslarını dikkate alınız.
All data on the page are theoretical.
Please consider the glass and gasket tolerance

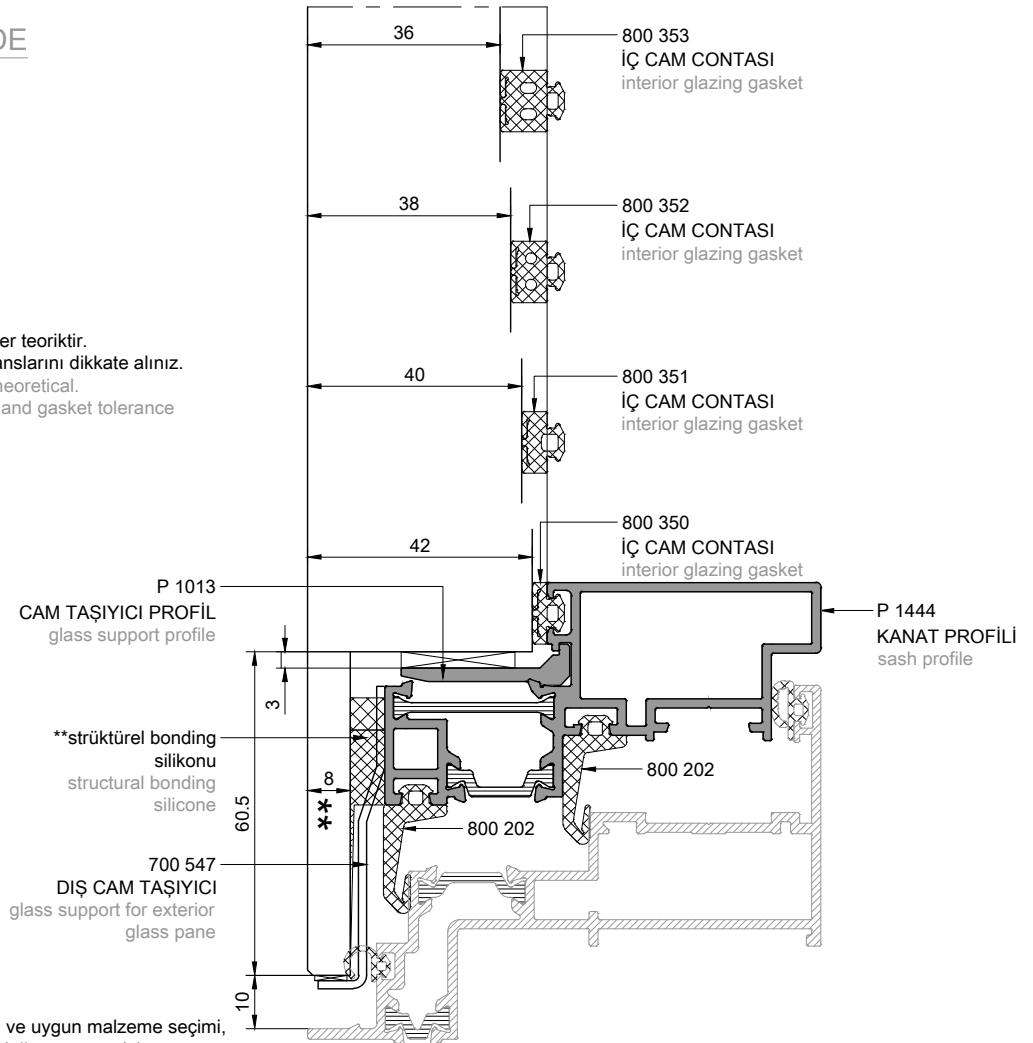

**

Strüktürel bonding silikonu özellikleri ve uygun malzeme seçimi,
gerekli hesapların yapılması sorumluluğu ve garantisi
uygulamacıya ve strüktürel bonding ve camlama yüklenicisine aittir.

Toz boyalı ve eloksallı alüminyum profile camların yapıştırılması ve
uygulaması ile ilgili uygulama ve malzeme konusunda garanti alınması, sorumluluğu uygulamacıya aittir.

Strüktürel bonding ile ilgili tüm testler uygulama firması tarafından yaptırılmalı ve test raporları KLEIDCO'ya gönderilmelidir.

Structurol bonding silicone properties and appropriate material selection ,making necessary calculations,responsibility
and warranty belong to the applicator and the structural bonding and glazing contractor.

All bonding procedures, bonding material choice and bonding quality management are under responsibility of Bonding Company.

All tests related to structural bonding be made by the Implementation company and the test reports should be send to KLEIDCO.

FS 50
STICK GİYDİRME CEPHE SİSTEMİ
STICK CURTAIN WALL SYSTEM

SİLİKON CEPHE
(CAM İÇİ ALUMİNYUM SPACERLI)
CAM KOMBİNASYONLARI
SILICONE FACADE
(INSIDE GLASS ALUMINIUM SPACER)
GLASS COMBINATIONS

****dış cam 6mm**
olması durumuna göre
32-34-36mm
kalınlıkta camlar için kombinasyon
****outside glass 6mm**
depending on the situation
combination for 32-34-36mm glass

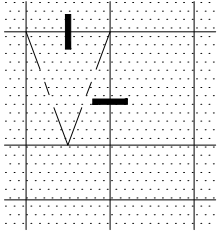
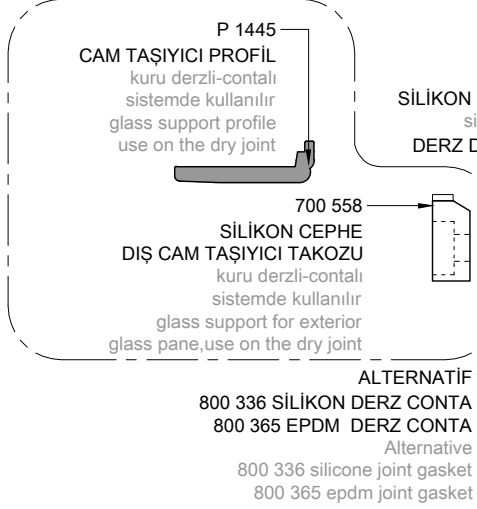

SİLİKON CEPHE SILICONE FACADE

Sayfada bulunan tüm veriler teoriktir.
Lütfen cam ve conta toleranslarını
dikkate alınız.
All data on the page are theoretical.
Please consider the glass and
gasket tolerance

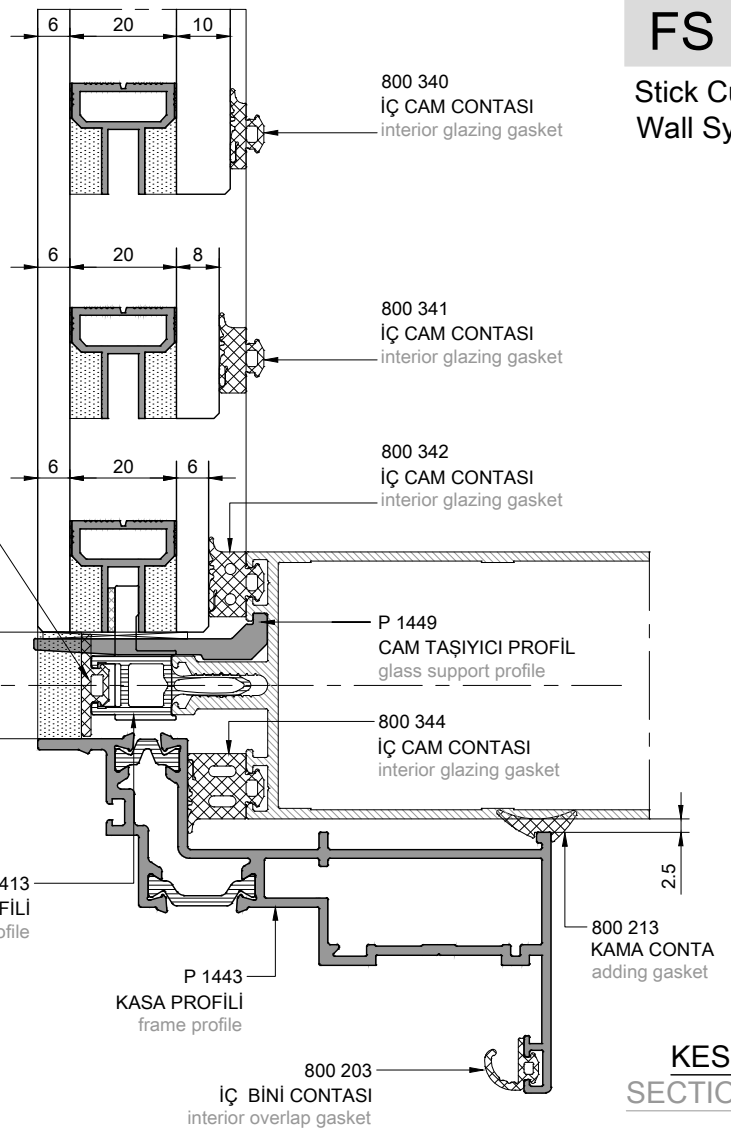

KESİT SECTION

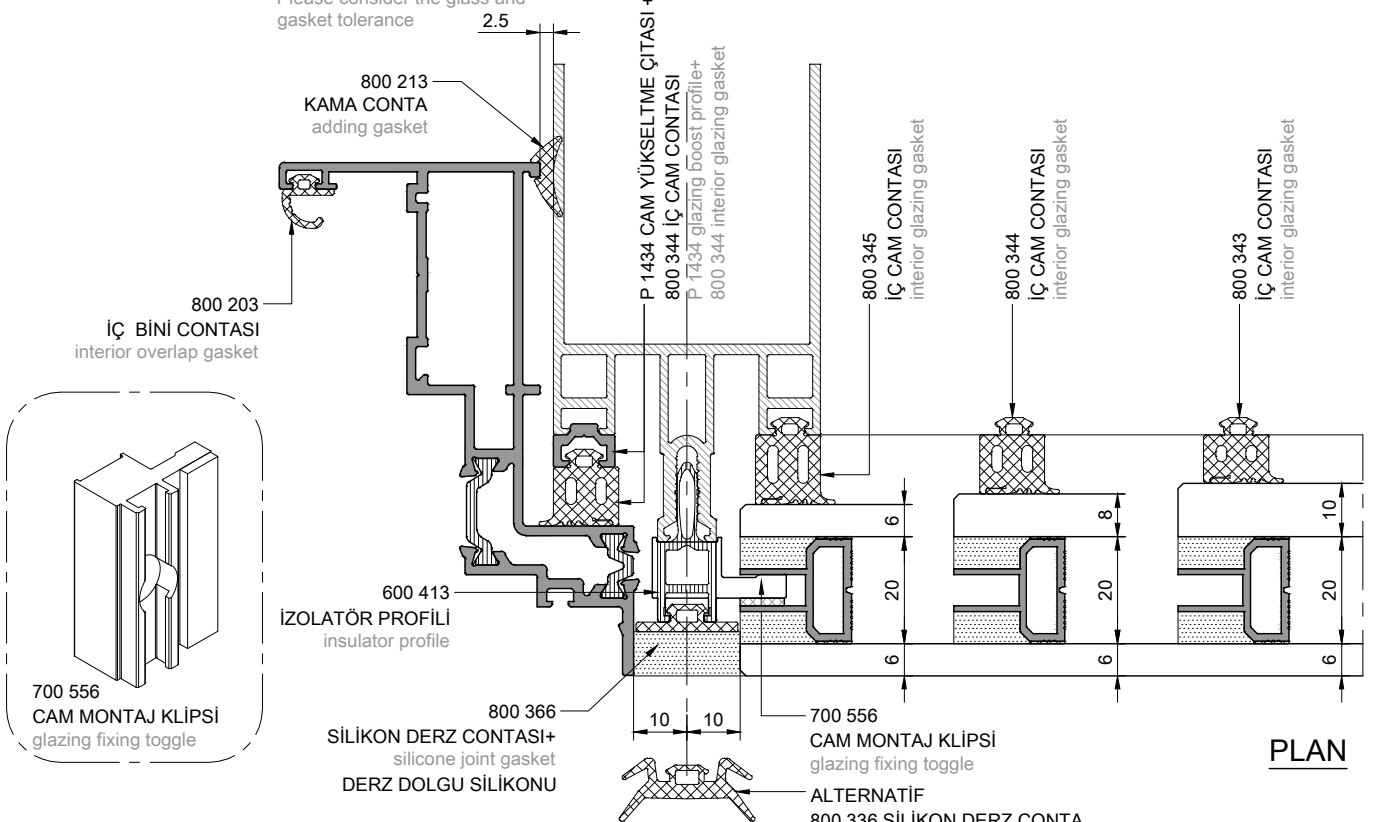

PLAN

**dış cam 8mm

olması durumuna göre

34-36-38mm

kalınlıkta camlar için kombinasyon

**outside glass 8mm

depending on the situation

combination for 34-36-38mm glass

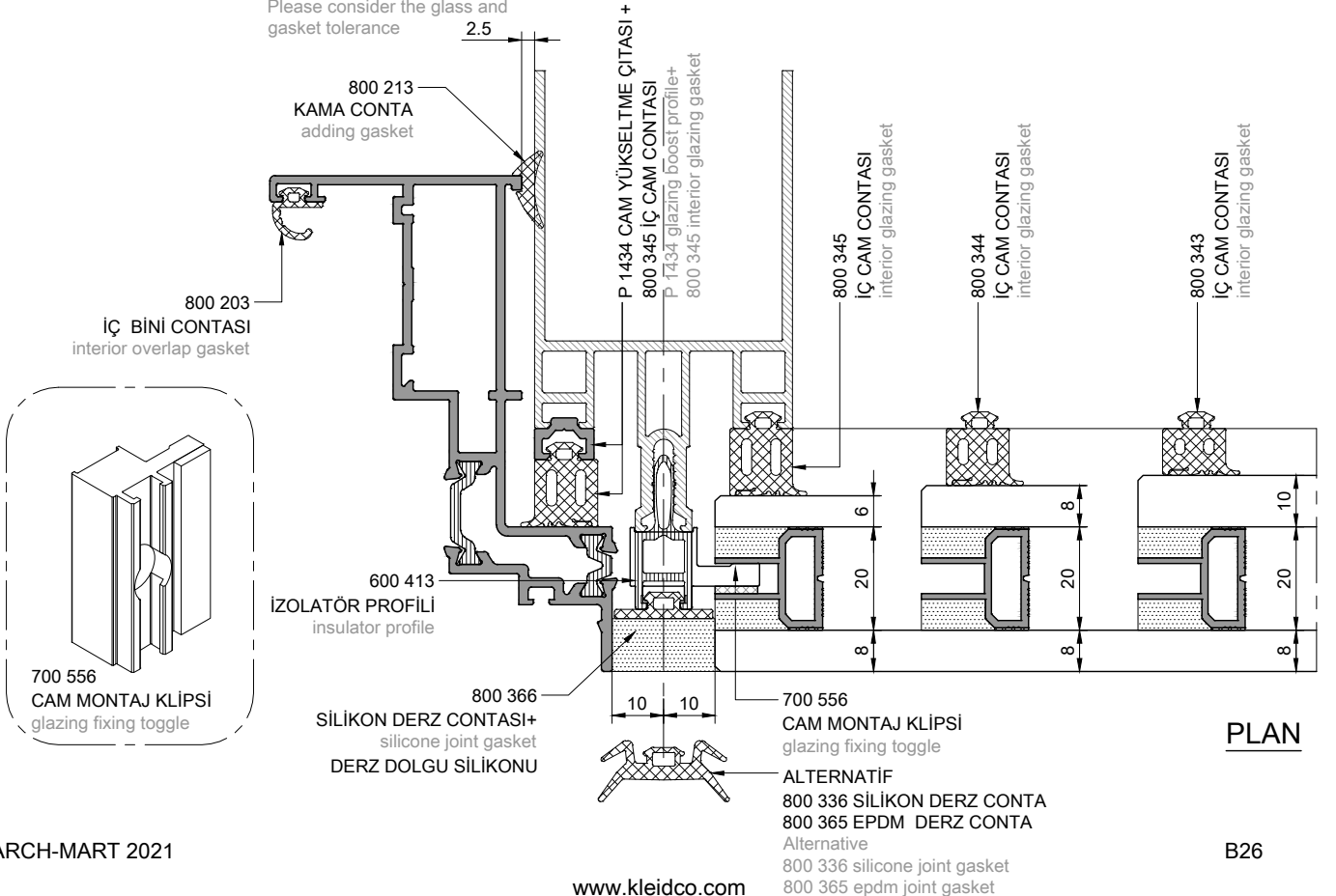
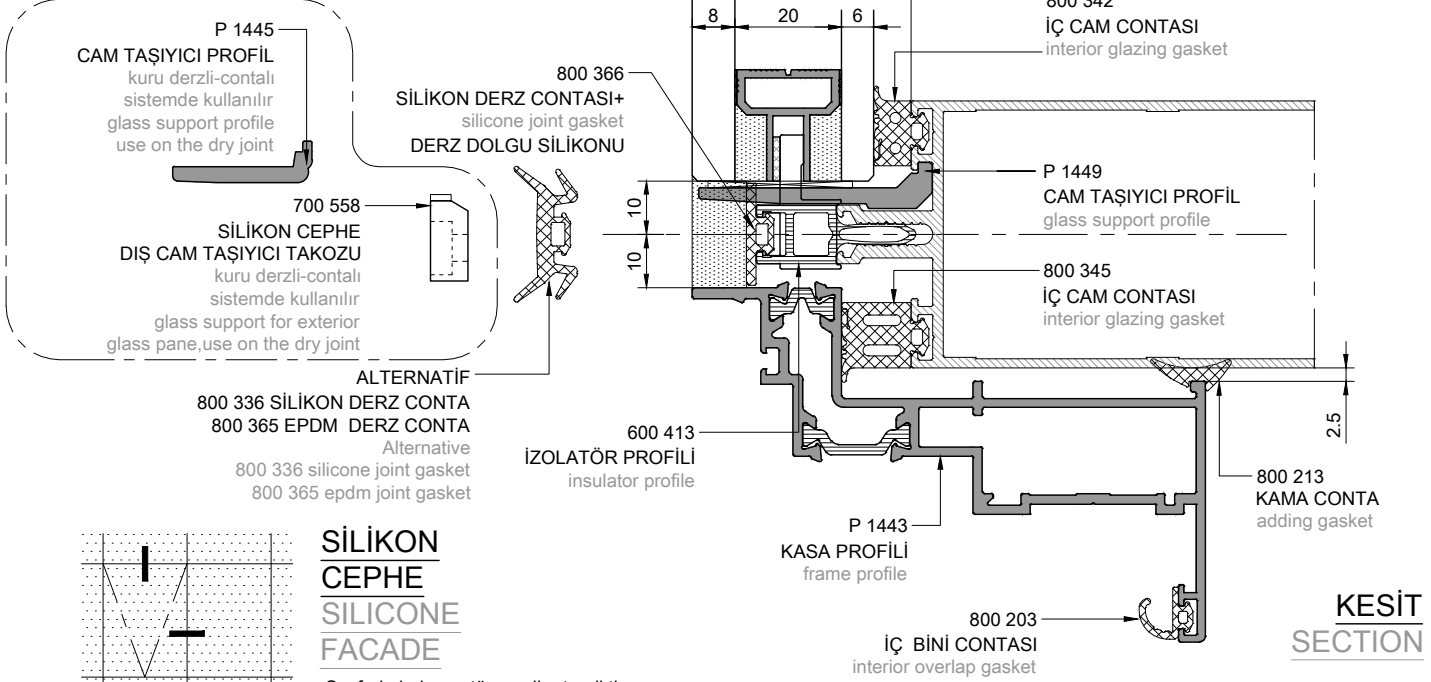

****dış cam 6mm
olması durumuna göre
38-40-42mm
kalınlıkta camlar için kombinasyon
**outside glass 6mm
depending on the situation
combination for 38-40-42mm glass**

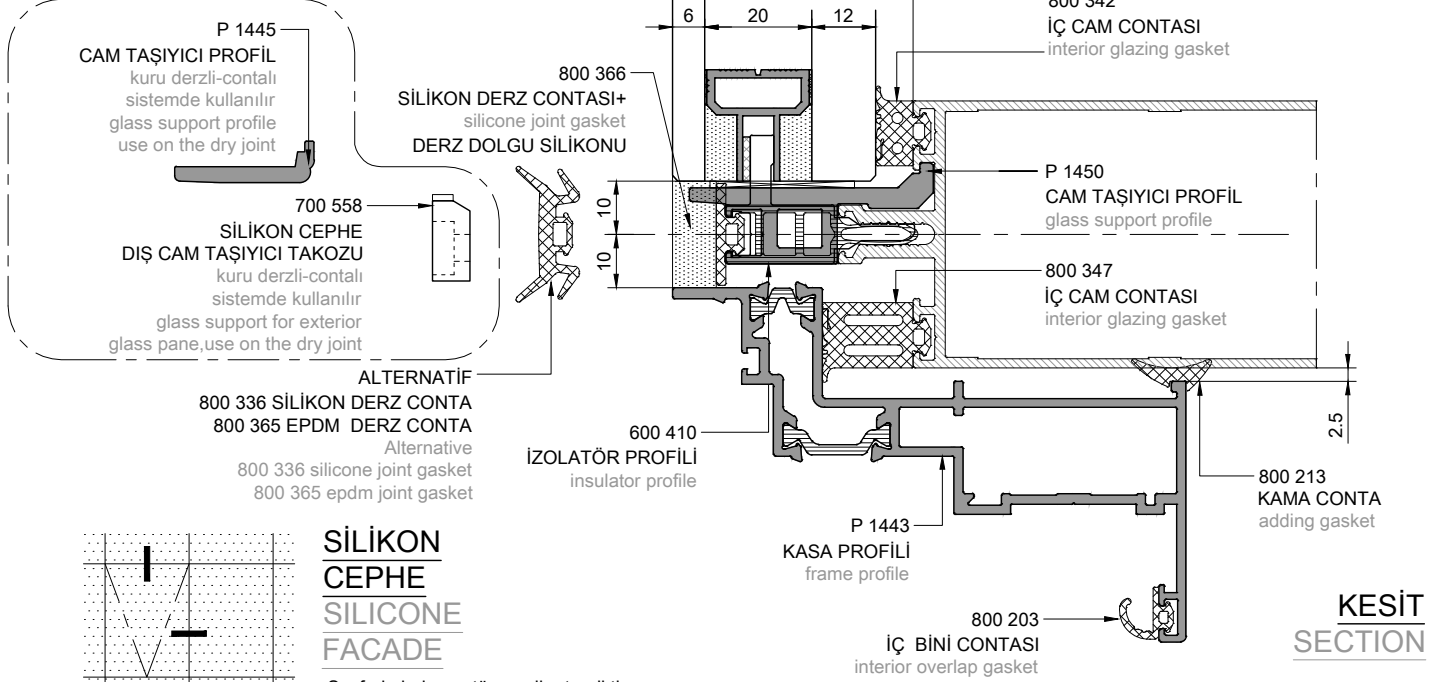

KESİT SECTION

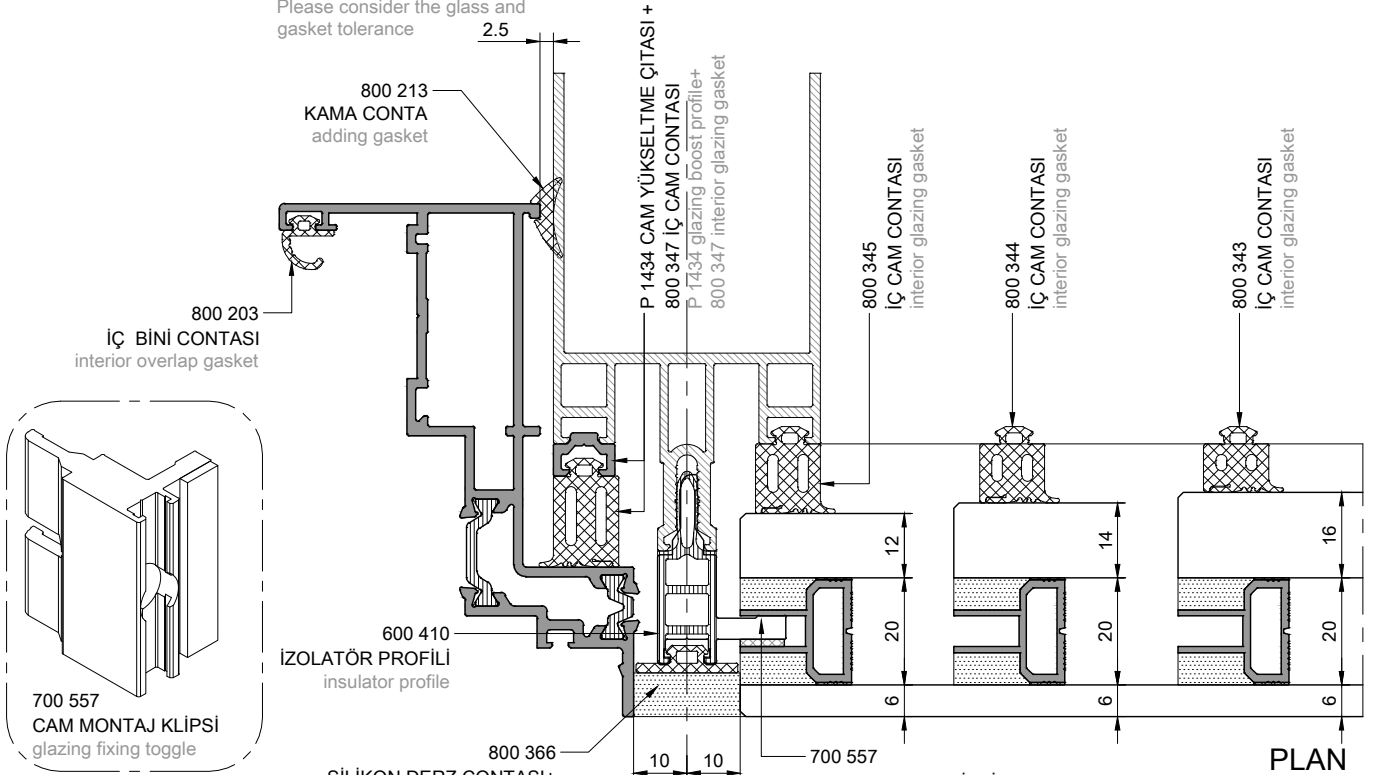

****dış cam 8mm
olması durumuna göre
40-42-44mm
kalınlıkta camlar için kombinasyon
**outside glass 8mm
depending on the situation
combination for 40-42-44mm glass**

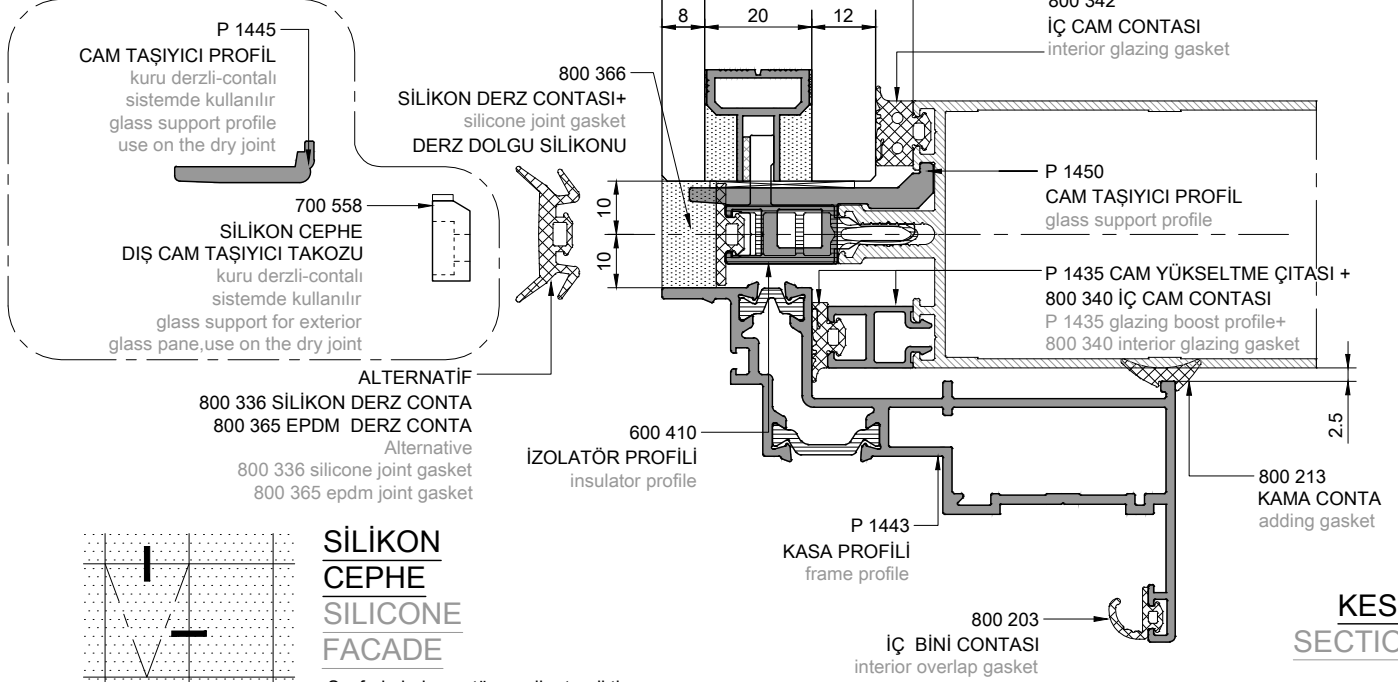

KESİT SECTION

SİLİKON CEPHE SILICONE FACADE

Sayfada bulunan tüm veriler teoriktir.
Lütfen cam ve conta toleranslarını
dikkate alınız.
All data on the page are theoretical.
Please consider the glass and
gasket tolerance

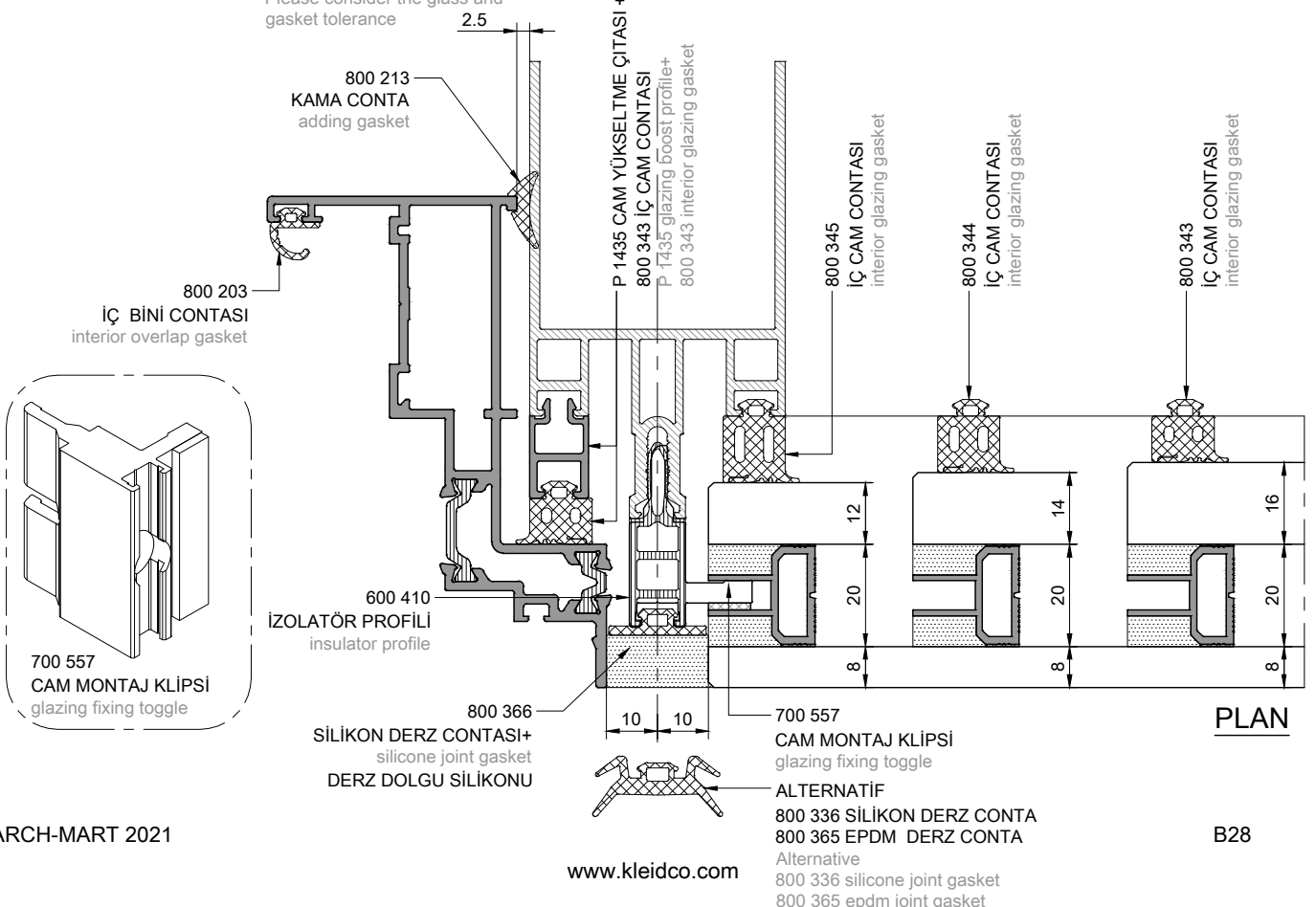

PLAN

FS 50
STICK GİYDİRME CEPHE SİSTEMİ
STICK CURTAIN WALL SYSTEM

SİLİKON CEPHE
(CAM İÇİ LOKAL U KANALLI)
TEK CAM-ÇİFT CAM KOMBİNASYONLARI
SILICONE FACADE
(INSIDE GLASS U CHANNEL)
SINGLE GLASS-DOUBLE GLASS
COMBINATIONS

****dış cam 6mm**

olması durumuna göre

28-30-32mm

kalınlıkta camlar için kombinasyon

****outside glass 6mm**

depending on the situation

combination for 28-30-32mm glass

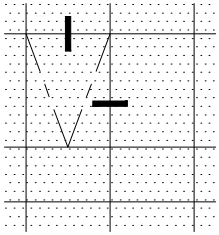
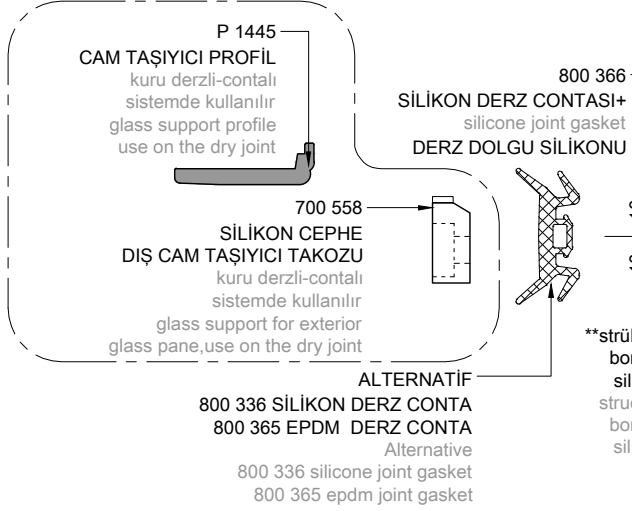

SİLİKON CEPHE SİLİKON FACADE

Sayfada bulunan tüm veriler teoriktir. Lütfen cam ve conta toleranslarını dikkate alınız.
All data on the page are theoretical. Please consider the glass and gasket tolerance

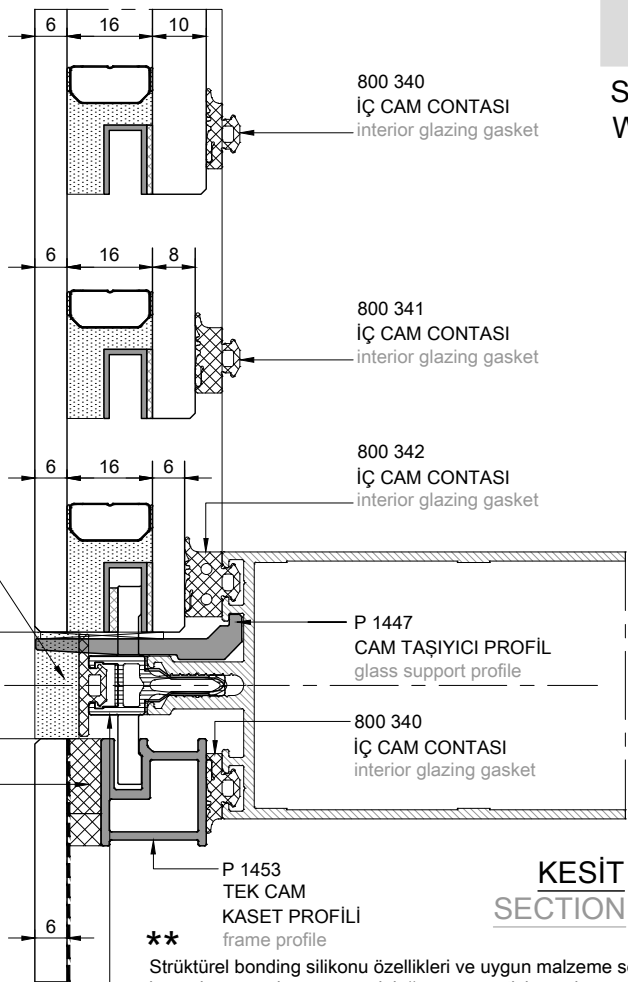

****** Strüktürel bonding silikonu özellikleri ve uygun malzeme seçimi, gerekli hesapların yapılması sorumluluğu ve garantisini uygulamaya ve strüktürel bonding ve camlama yüklenicisine aittir. Toz boyalı ve eloksalı alüminyum profile camların yapıştırılması ve uygulaması ile ilgili uygulama ve malzeme konusunda garanti alınması, sorumluluğu uygulamaya aittir. Strüktürel bonding ile ilgili tüm testler uygulama firması tarafından yaptırılmalı ve test raporları KLEIDCO'ya gönderilmelidir.
Structural bonding silicone properties and appropriate material selection, making necessary calculations, responsibility and warranty belong to the applicator and the structural bonding and glazing contractor. All bonding procedures, bonding material choice and bonding quality management are under responsibility of Bonding Company. All tests related to structural bonding be made by the Implementation company and the test reports should be send to KLEIDCO.

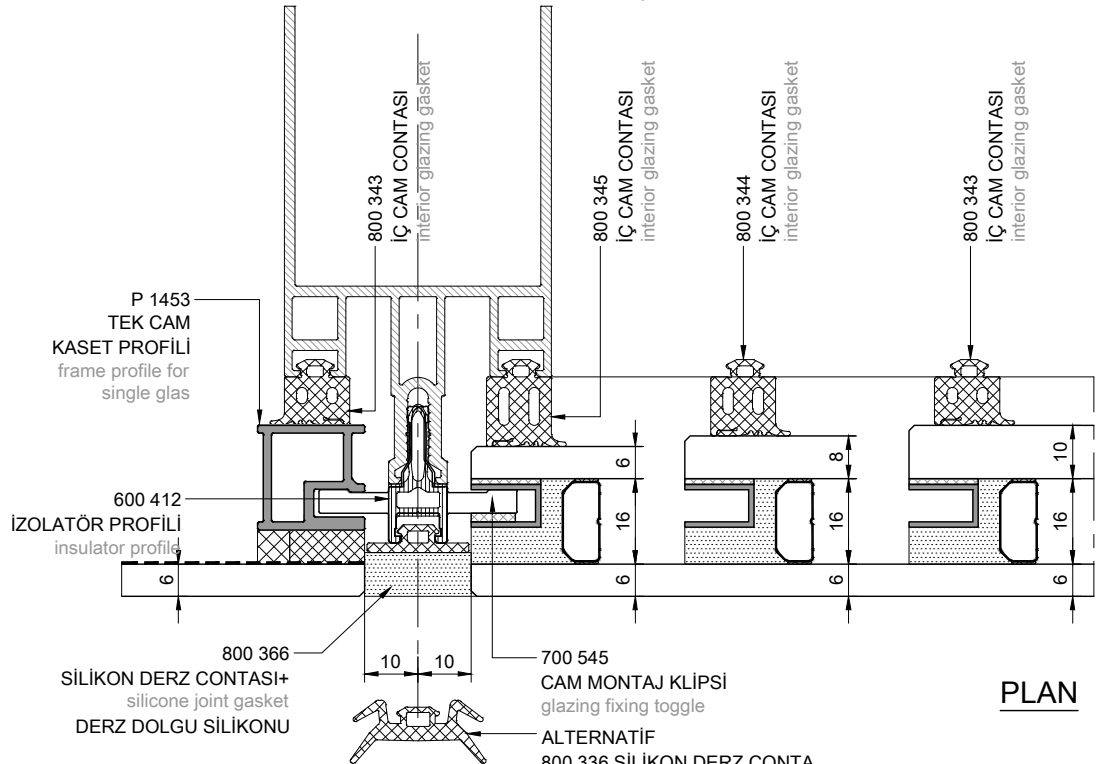
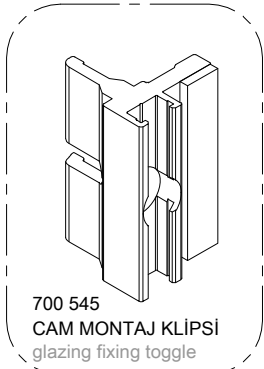

****dış cam 8mm**
olması durumuna göre
30-32-34mm
kalınlıkta camlar için kombinasyon
****outside glass 8mm**
depending on the situation
combination for 30-32-34mm glass

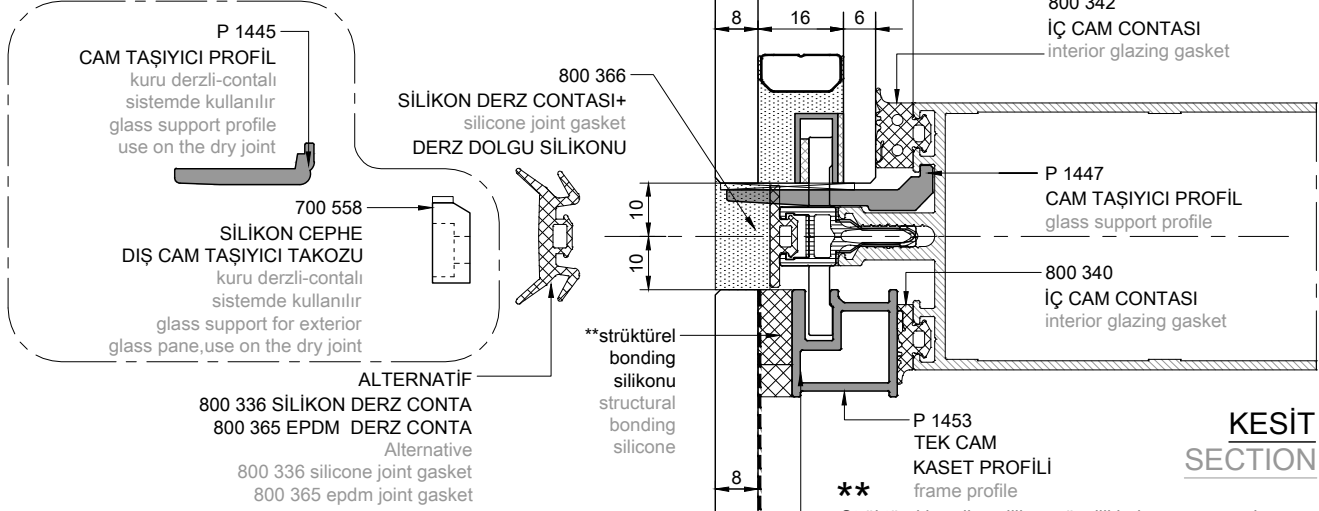

KESİT SECTION

****** Strüktürel bonding silikonu özellikleri ve uygun malzeme seçimi, gerekli hesapların yapılması sorumluluğu ve garantisini uygulamaya ve strüktürel bonding ve camlama yüklenicisine aittir. Toz boyalı ve eloksallı alüminyum profile camların yapıştırılması ve uygulaması ile ilgili uygulama ve malzeme konusunda garanti alınması, sorumluluğu uygulamaya aittir. Strüktürel bonding ile ilgili tüm testler uygulama firması tarafından yaptırılmalı ve test raporları KLEIDCO'ya gönderilmelidir.

Structural bonding silicone properties and appropriate material selection, making necessary calculations, responsibility and warranty belong to the applicator and the structural bonding and glazing contractor.

All bonding procedures, bonding material choice and bonding quality management are under responsibility of Bonding Company.

All tests related to structural bonding be made by the Implementation company and the test reports should be send to KLEIDCO.

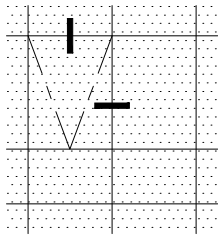

SİLİKON CEPHE SİLİKON FACADE

Sayfada bulunan tüm veriler teoriktir. Lütfen cam ve conta toleranslarını dikkate alınız.

All data on the page are theoretical. Please consider the glass and gasket tolerance

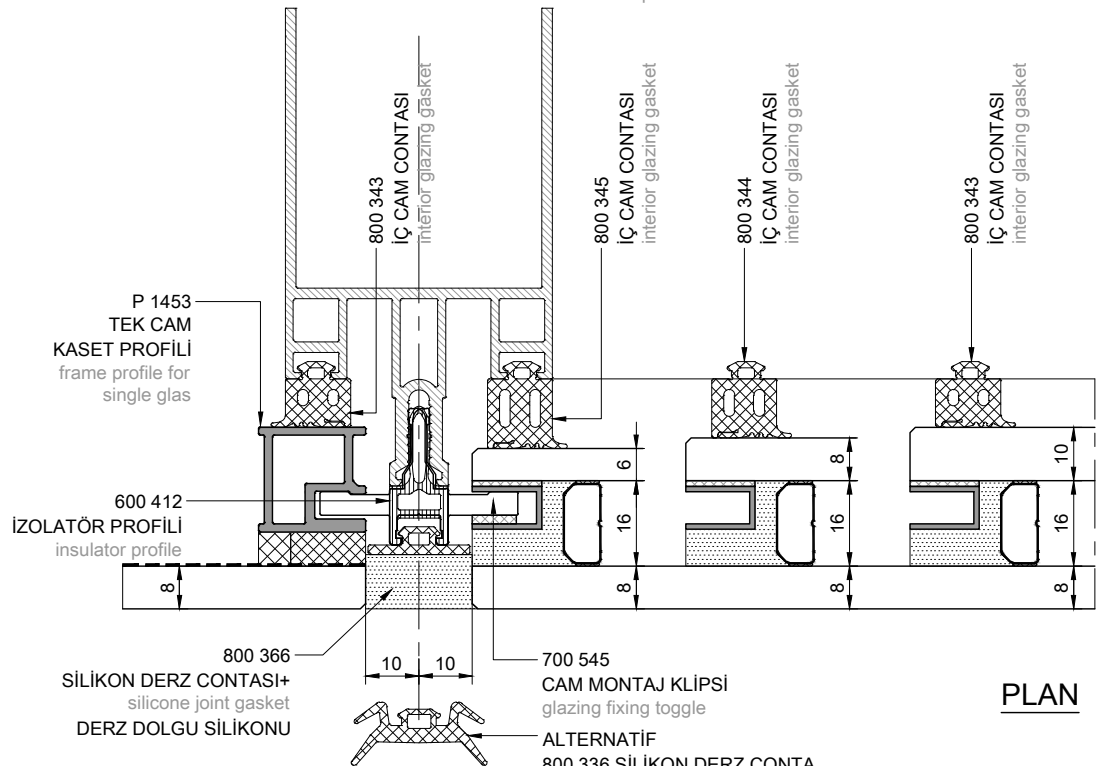
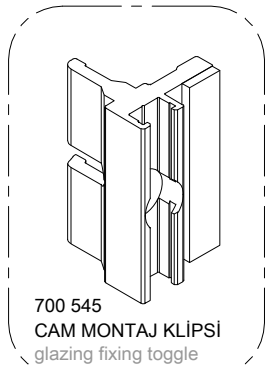

PLAN

****dış cam 6mm**

olması durumuna göre

34-36-38mm

kalınlıkta camlar için kombinasyon

****outside glass 6mm**

depending on the situation

combination for 34-36-38mm glass

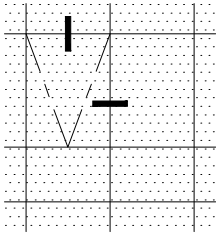
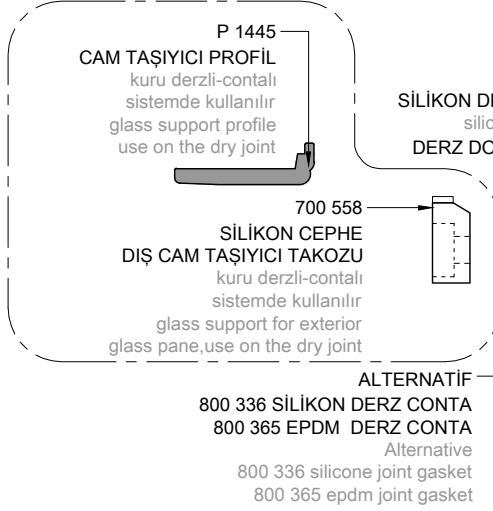

SİLİKON CEPHE SILICONE FACADE

Sayfada bulunan tüm veriler teoriktir.
Lütfen cam ve conta toleranslarını
dikkate alınız.

All data on the page are theoretical.
Please consider the glass and
gasket tolerance

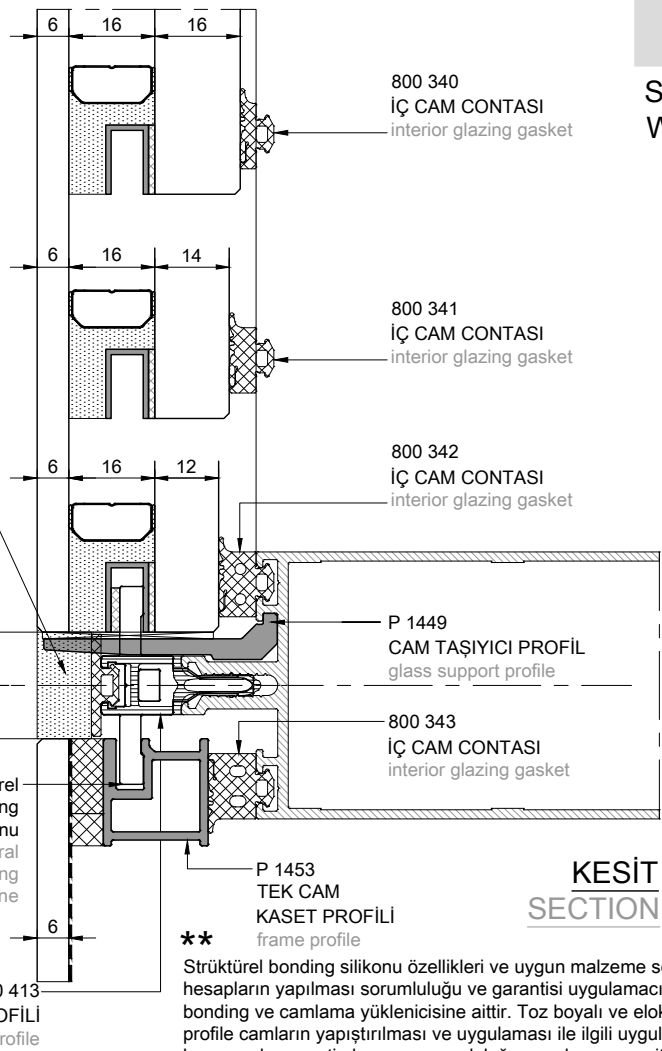

Strüktürel bonding silikonu özellikleri ve uygun malzeme seçimi, gerekli hesapların yapılması sorumluluğu ve garantisi uygulamacıya ve strüktürel bonding ve camlama yüklenicisine aittir. Toz boyalı ve eloksallı alüminyum profile camların yapıştırılması ve uygulaması ile ilgili uygulama ve malzeme konusunda garanti alınması, sorumluluğu uygulamacıya aittir. Strüktürel bonding ile ilgili tüm testler uygulama firması tarafından yaptırılmalı ve test raporları KLEIDCO'ya gönderilmelidir.

Structural bonding silicone properties and appropriate material selection , making necessary calculations, responsibility and warranty belong to the applicator and the structural bonding and glazing contractor.

All bonding procedures, bonding material choice and bonding quality management are under responsibility of Bonding Company.

All tests related to structural bonding be made by the Implementation company and the test reports should be send to KLEIDCO.

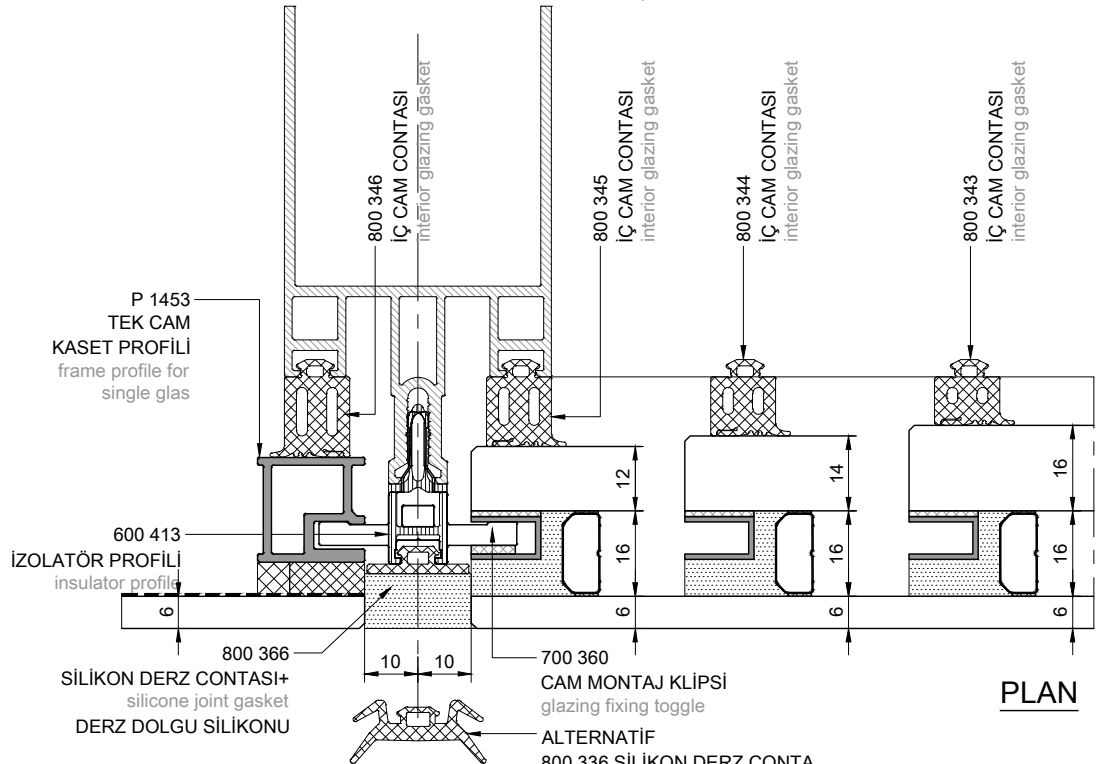
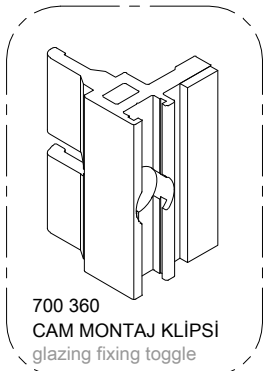

****dış cam 8mm**
olması durumuna göre
36-38-40mm
kalınlıkta camlar için kombinasyon
****outside glass 8mm**
depending on the situation
combination for 36-38-40mm glass

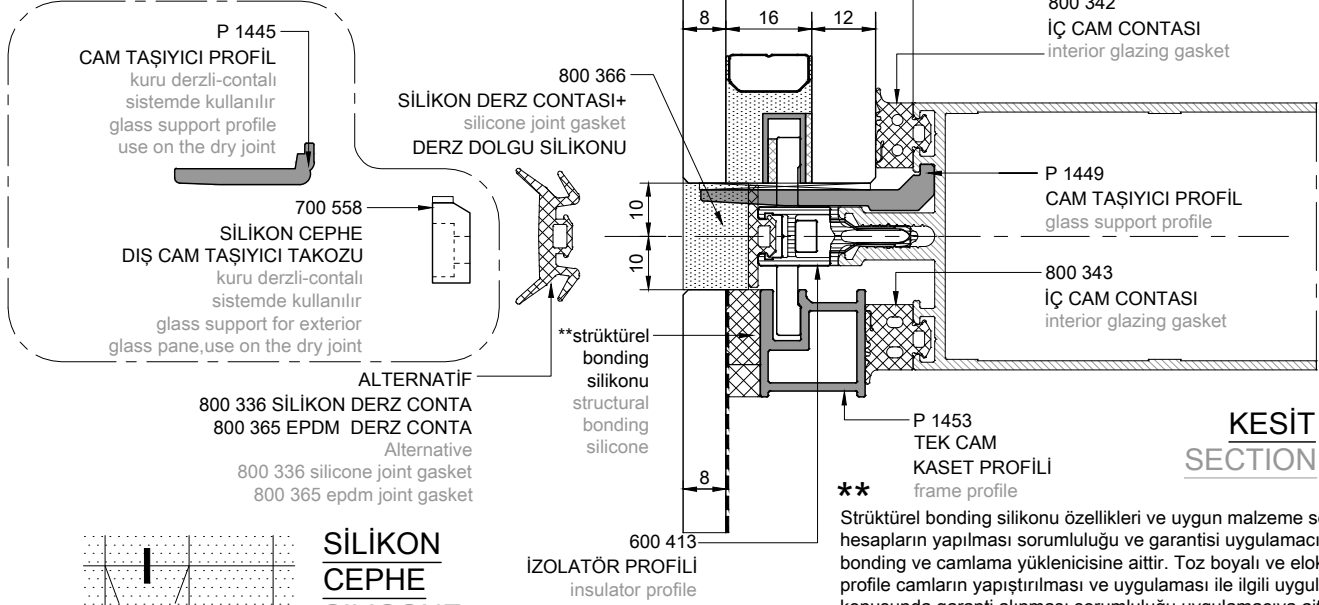

KESİT SECTION

****** Strüktürel bonding silikonu özellikleri ve uygun malzeme seçimi, gerekli hesapların yapılması sorumluluğu ve garantisi uygulamacıya ve strüktürel bonding ve camlama yüklenicisine aittir. Toz boyalı ve eloksallı alüminyum profile camların yapıştırılması ve uygulaması ile ilgili uygulama ve malzeme konusunda garanti alınması, sorumluluğu uygulamacıya aittir. Strüktürel bonding ile ilgili tüm testler uygulama firması tarafından yaptırılmalı ve test raporları KLEIDCO'ya gönderilmelidir.

Structural bonding silicone properties and appropriate material selection, making necessary calculations, responsibility and warranty belong to the applicator and the structural bonding and glazing contractor.

All bonding procedures, bonding material choice and bonding quality management are under responsibility of Bonding Company.

All tests related to structural bonding be made by the Implementation company and the test reports should be send to KLEIDCO.

SİLİKON CEPHE SILICONE FACADE

Sayfada bulunan tüm veriler teoriktir. Lütfen cam ve conta toleranslarını dikkate alınız.

All data on the page are theoretical. Please consider the glass and gasket tolerance

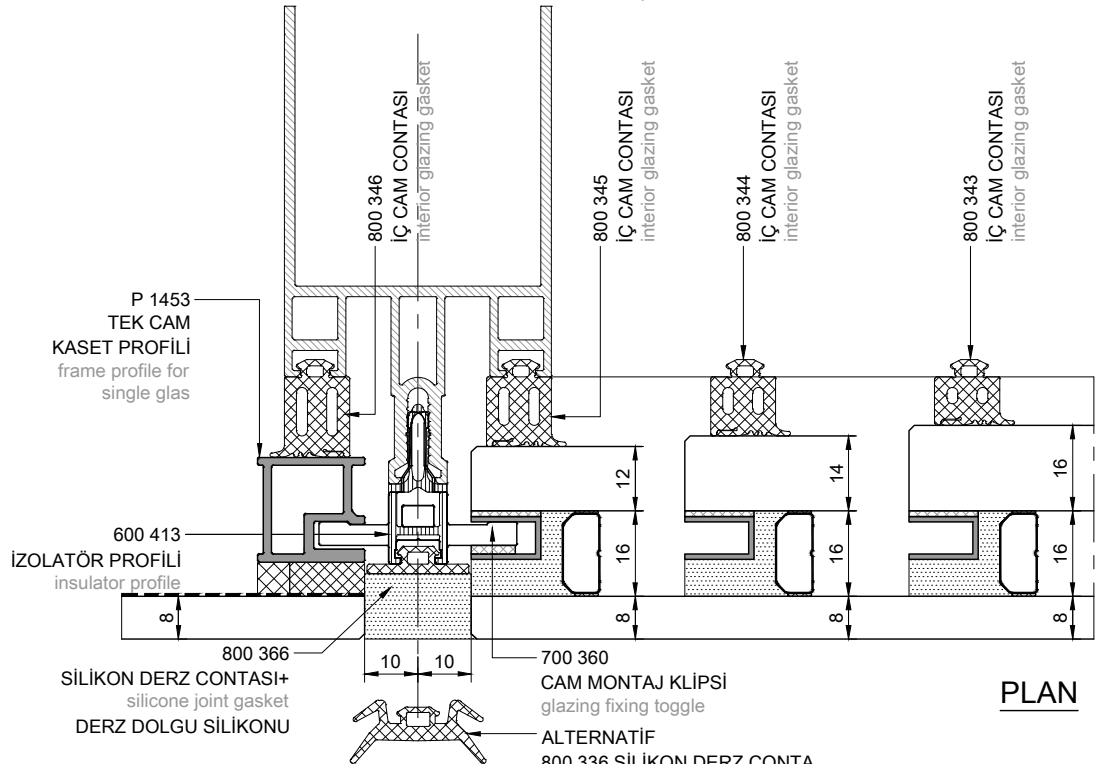

PLAN

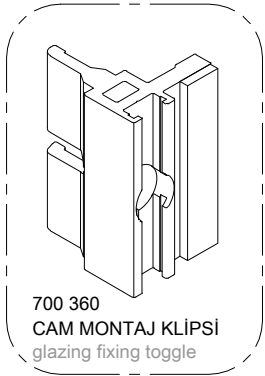

FS 50
STICK GİYDİRME CEPHE SİSTEMİ
STICK CURTAIN WALL SYSTEM

SİLİKON CEPHE
(CAM İÇİ ALUMİNYUM SPACERLI)
TEK CAM-ÇİFT CAM KOMBİNASYONLARI
SILICONE FACADE
(INSIDE GLASS ALUMINIUM SPACER)
SINGLE GLASS-DOUBLE GLASS
COMBINATION

****dış cam 6mm**
olması durumuna göre
32-34-36mm
kalınlıkta camlar için kombinasyon
****outside glass 6mm**
depending on the situation
combination for 32-34-36mm glass

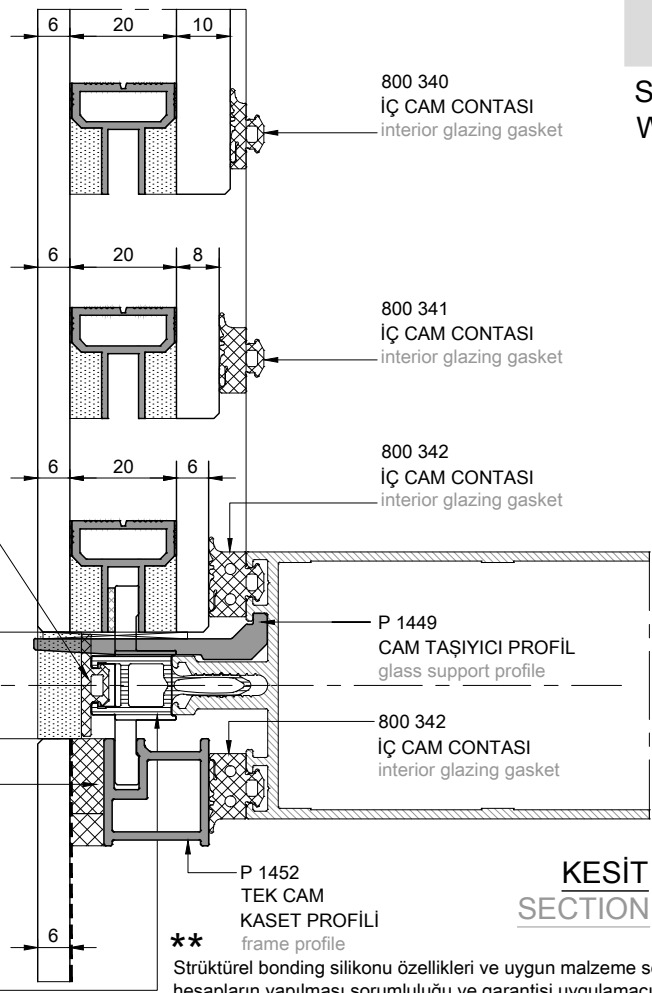
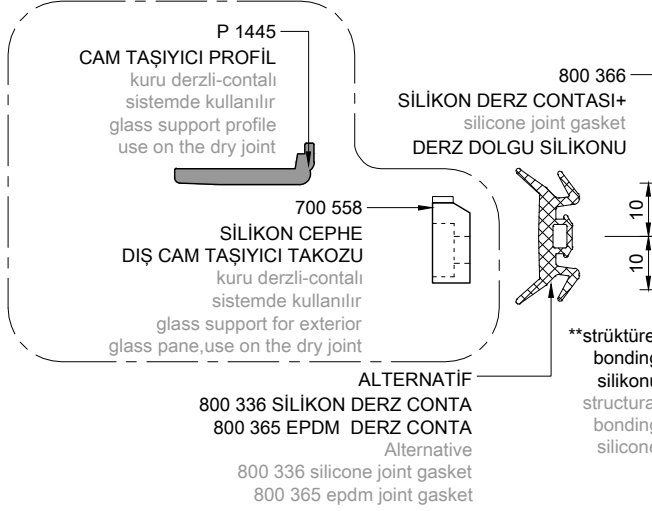

KESİT SECTION

Strüktürel bonding silikonu özellikleri ve uygun malzeme seçimi, gerekli hesapların yapılması sorumluluğu ve garantisini uygulamacıya ve strüktürel bonding ve camlama yüklenicisine aittir. Toz boyalı ve eloksallı alüminyum profile camların yapıştırılması ve uygulaması ile ilgili uygulama ve malzeme konusunda garanti alınması, sorumluluğu uygulamacıya aittir. Strüktürel bonding ile ilgili tüm testler uygulama firması tarafından yaptırılmalı ve test raporları KLEIDCO'ya gönderilmelidir.

Structural bonding silicone properties and appropriate material selection, making necessary calculations, responsibility and warranty belong to the applicator and the structural bonding and glazing contractor.

All bonding procedures, bonding material choice and bonding quality management are under responsibility of Bonding Company.

All tests related to structural bonding be made by the Implementation company and the test reports should be send to KLEIDCO.

SİLİKON CEPHE SILICONE FACADE

Sayfada bulunan tüm veriler teoriktir.
Lütfen cam ve conta toleranslarını
dikkate alınız.
All data on the page are theoretical.
Please consider the glass and
gasket tolerance

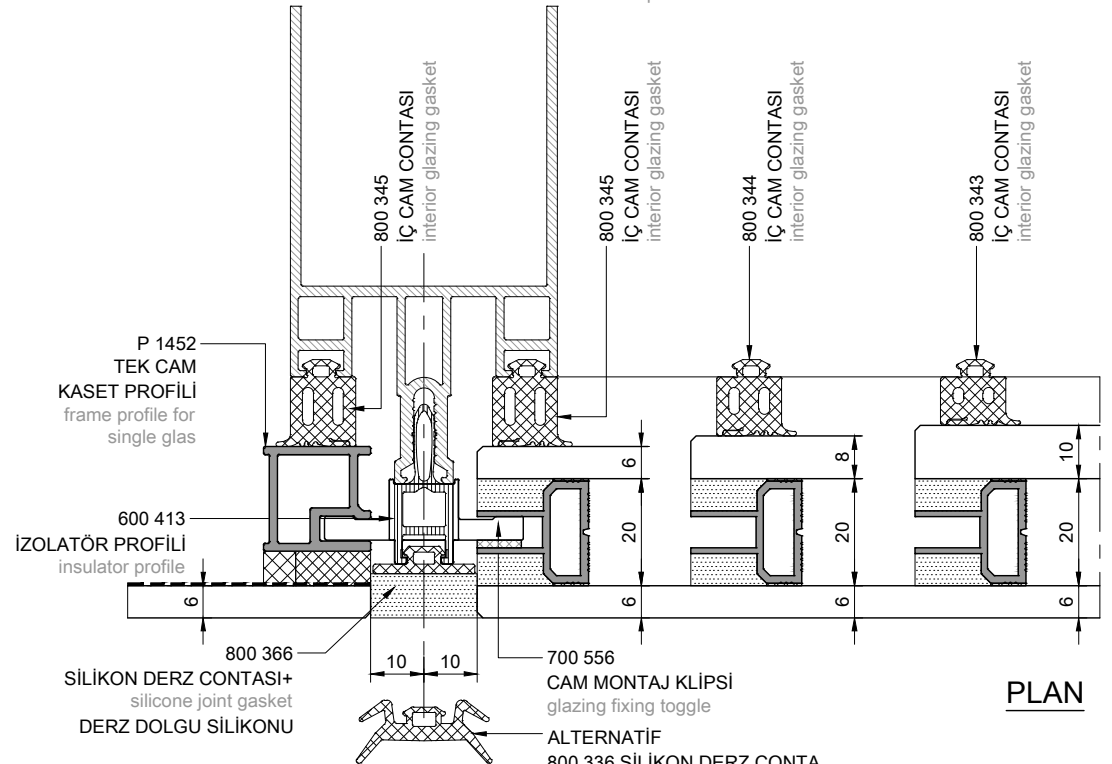
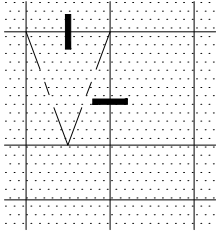

PLAN

****dış cam 8mm**
olması durumuna göre
34-36-38mm
kalınlıkta camlar için kombinasyon
****outside glass 8mm**
depending on the situation
combination for 34-36-38mm glass

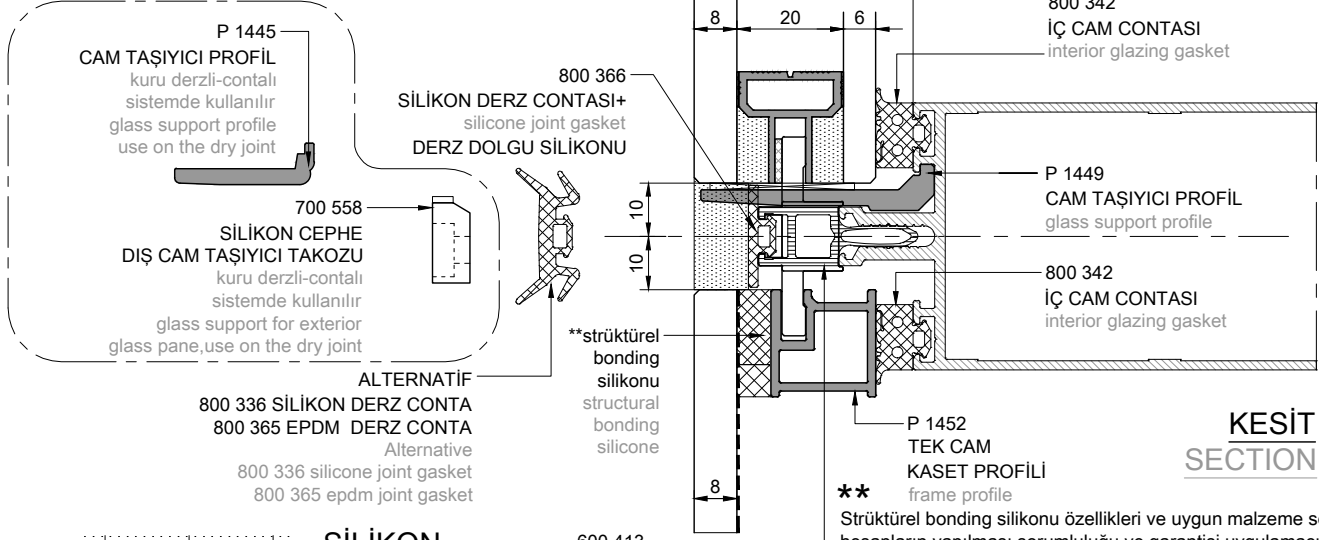

KESİT SECTION

****** Strüktürel bonding silikonu özellikleri ve uygun malzeme seçimi, gerekli hesapların yapılması sorumluluğu ve garantisini uygulamacıya ve strüktürel bonding ve camlama yüklenicisine aittir. Toz boyalı ve eloksallı alüminyum profile camların yapıştırılması ve uygulaması ile ilgili uygulama ve malzeme konusunda garanti alınması, sorumluluğu uygulamacıya aittir. Strüktürel bonding ile ilgili tüm testler uygulama firması tarafından yaptırılmalı ve test raporları KLEIDCO'ya gönderilmelidir.

Structural bonding silicone properties and appropriate material selection, making necessary calculations, responsibility and warranty belong to the applicator and the structural bonding and glazing contractor.

All bonding procedures, bonding material choice and bonding quality management are under responsibility of Bonding Company.

All tests related to structural bonding be made by the Implementation company and the test reports should be send to KLEIDCO.

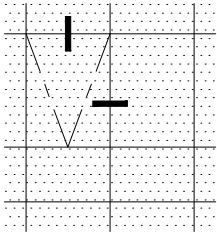

SİLİKON CEPHE SİLİKON FACADE

Sayfada bulunan tüm veriler teoriktir. Lütfen cam ve conta toleranslarını dikkate alınınız.

All data on the page are theoretical. Please consider the glass and gasket tolerance

600 413 İZOLATÖR PROFİLİ insulator profile

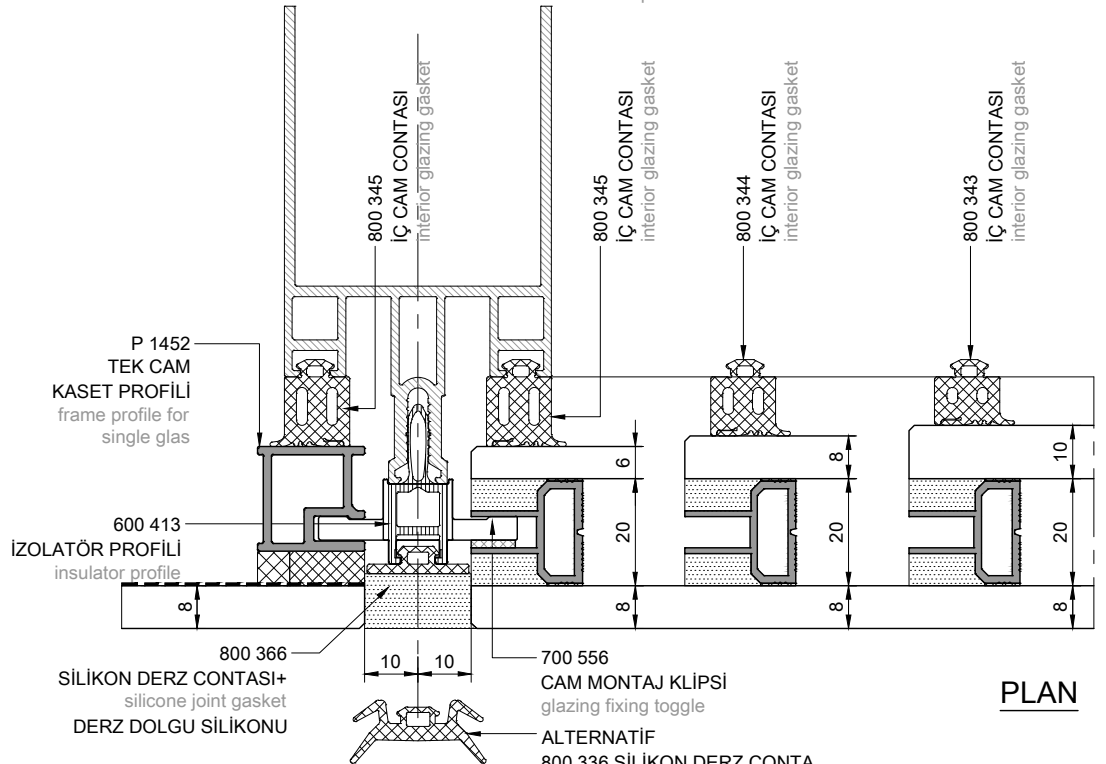

PLAN

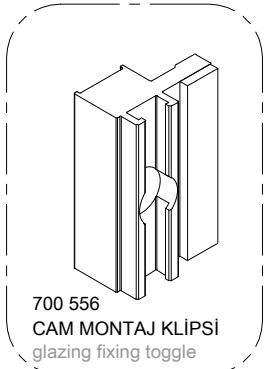

700 556
CAM MONTAJ KLİPSİ
glazing fixing toggle

800 366
SİLİKON DERZ CONTASI+
DERZ DOLGU SİLİKONU

700 556
CAM MONTAJ KLİPSİ
glazing fixing toggle

ALTERNATİF
800 336 SİLİKON DERZ CONTA
800 365 EPDM DERZ CONTA
Alternative
800 336 silicone joint gasket
800 365 epdm joint gasket

****dış cam 6mm**

olması durumuna göre

38-40-42mm

kalınlıkta camlar için kombinasyon

****outside glass 6mm**

depending on the situation

combination for 38-40-42mm glass

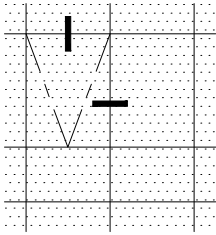
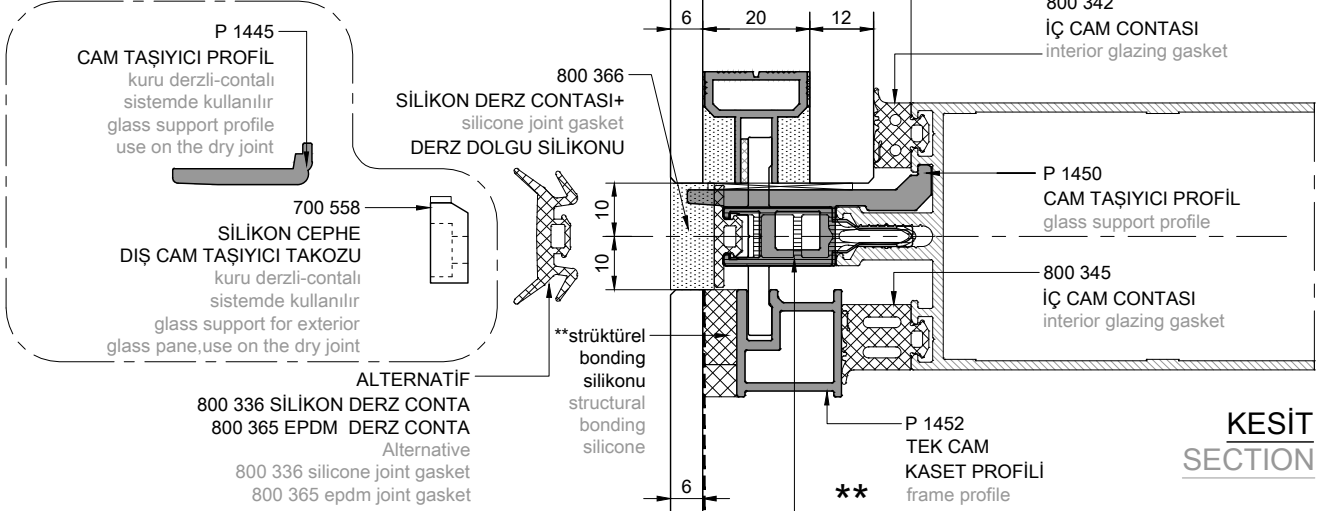

SİLİKON CEPHE SİLİKON SİLİKON FACADE

Sayfada bulunan tüm veriler teoriktir. Lütfen cam ve conta toleranslarını dikkate alınız.
All data on the page are theoretical. Please consider the glass and gasket tolerance

****** Strüktürel bonding silikonu özellikleri ve uygun malzeme seçimi, gerekli hesapların yapılması sorumluluğu ve garantisini uygulamacıya ve strüktürel bonding ve camlama yüklenicisine aittir. Toz boyalı ve eloksallı alüminyum profile camların yapıştırılması ve uygulaması ile ilgili uygulama ve malzeme konusunda garanti alınması, sorumluluğu uygulamacıya aittir. Strüktürel bonding ile ilgili tüm testler uygulama firması tarafından yaptırılmalı ve test raporları KLEIDCO'ya gönderilmelidir.
Structural bonding silicone properties and appropriate material selection, making necessary calculations, responsibility and warranty belong to the applicator and the structural bonding and glazing contractor. All bonding procedures, bonding material choice and bonding quality management are under responsibility of Bonding Company. All tests related to structural bonding be made by the Implementation company and the test reports should be send to KLEIDCO.

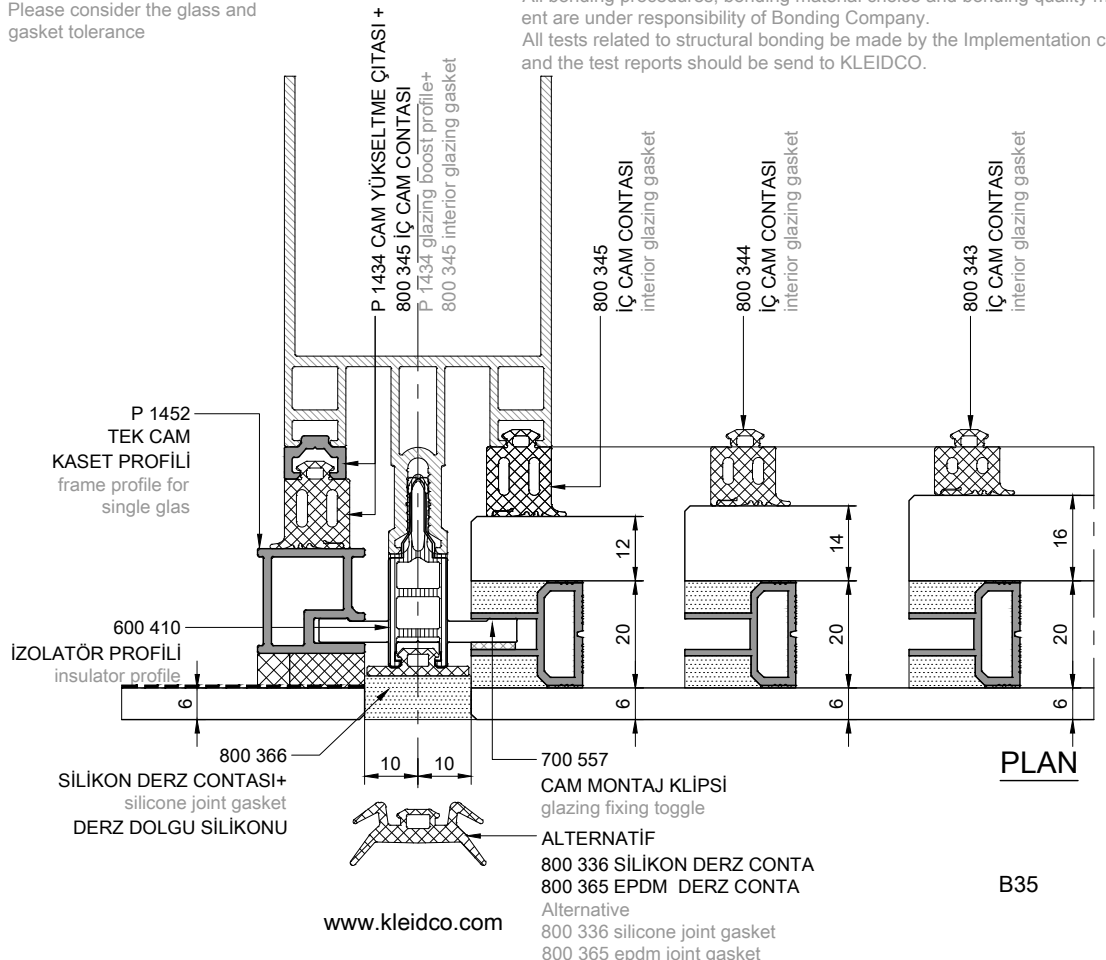
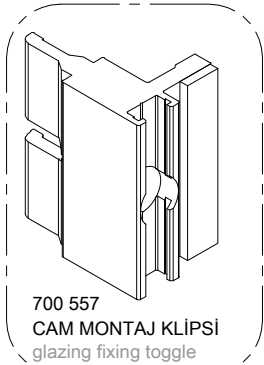

**dış cam 8mm

olması durumuna göre

40-42-44mm

kalınlıkta camlar için kombinasyon

**outside glass 8mm

depending on the situation

combination for 40-42-44mm glass

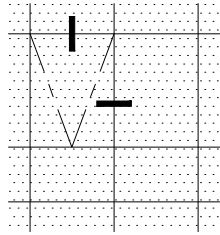
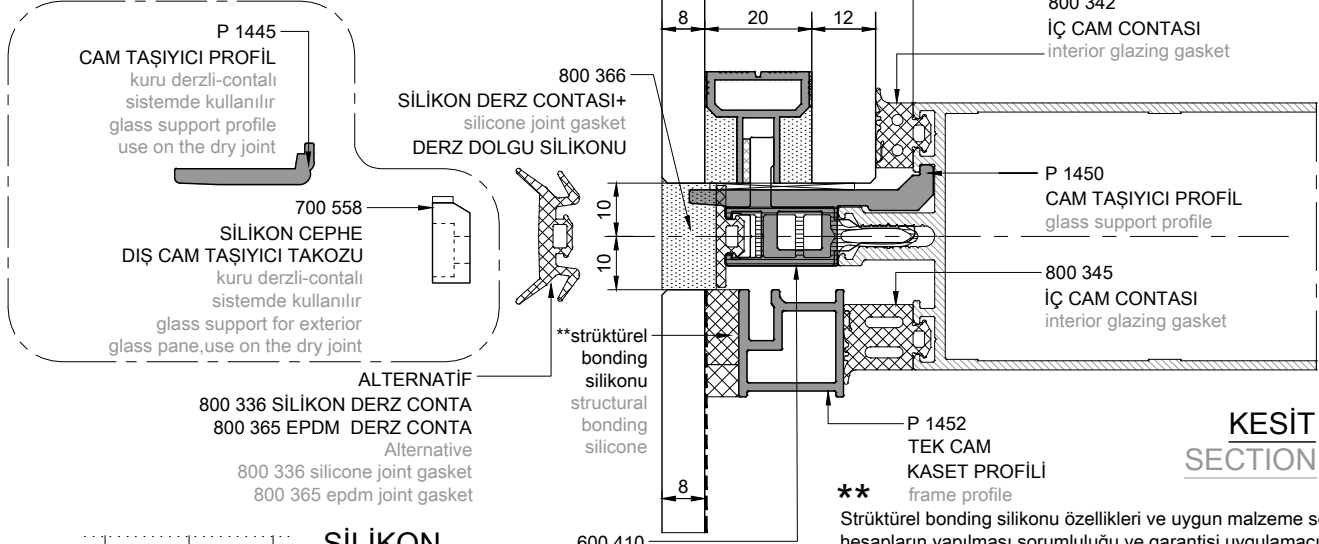

SİLİKON CEPHE SİLİKON FACADE

Sayfada bulunan tüm veriler teoriktir.
Lütfen cam ve conta toleranslarını dikkate alınız.
All data on the page are theoretical.
Please consider the glass and gasket tolerance

****** Strüktürel bonding silikonu özellikleri ve uygun malzeme seçimi, gerekli hesapların yapılması sorumluluğu ve garantisini uygulamacıya ve strüktürel bonding ve camlama yüklenicisine aittir. Toz boyalı ve eloksallı alüminyum profile camların yapıştırılması ve uygulaması ile ilgili uygulama ve malzeme konusunda garanti alınması, sorumluluğu uygulamacıya aittir. Strüktürel bonding ile ilgili tüm testler uygulama firması tarafından yaptırılmalı ve test raporları KLEIDCO'ya gönderilmelidir.
Structural bonding silicone properties and appropriate material selection, making necessary calculations, responsibility and warranty belong to the applicator and the structural bonding and glazing contractor.
All bonding procedures, bonding material choice and bonding quality management are under responsibility of Bonding Company.
All tests related to structural bonding be made by the Implementation company and the test reports should be send to KLEIDCO.

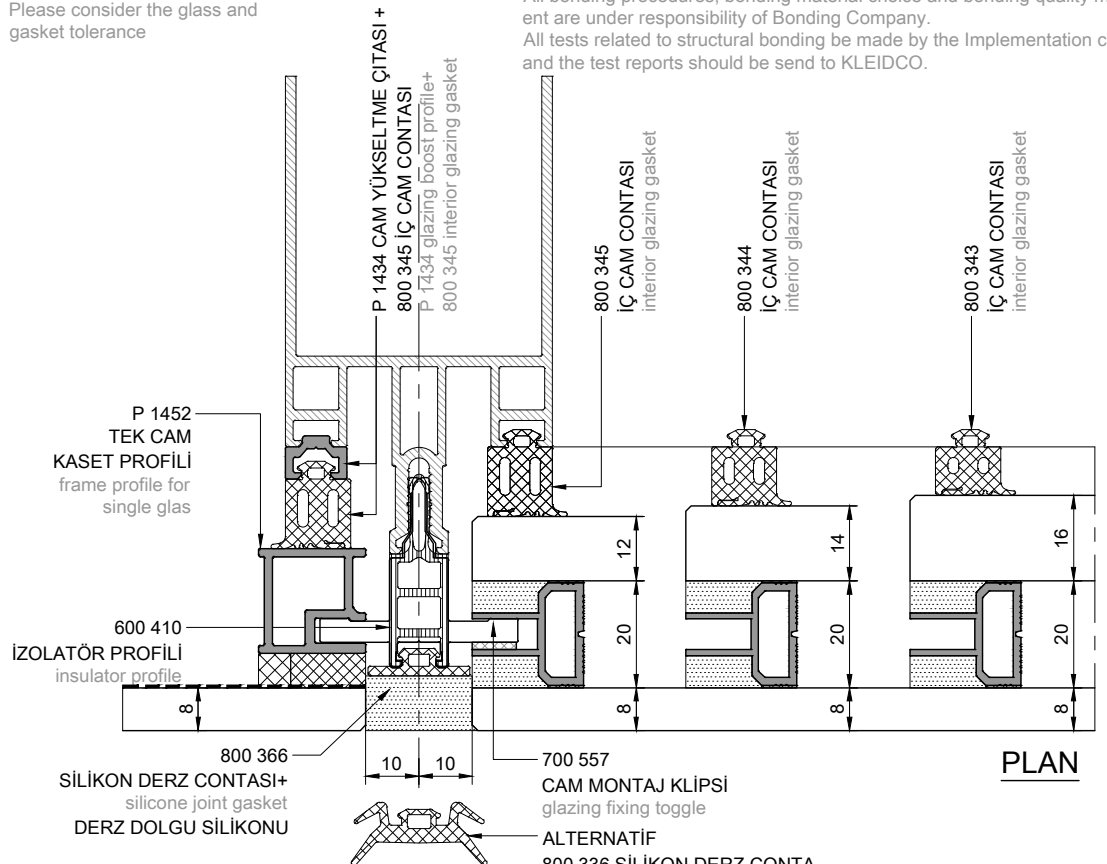
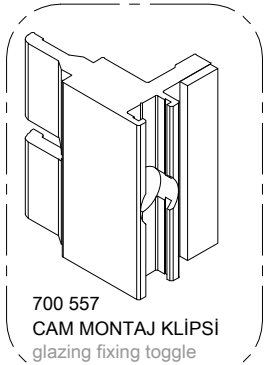

FS 50
STICK GİYDİRME CEPHE SİSTEMİ
STICK CURTAIN WALL SYSTEM

YATAY yada DÜŞEY KAPAKLI
SİLİKON CEPHE
(CAM İÇİ LOKAL U KANALLI)
CAM KOMBİNASYONLARI
HORIZONTAL OR VERTICAL CAPPED
SILICONE FACADE
(INSIDE GLASS U CHANNEL)
GLASS COMBINATIONS

****dış cam 6mm
olması durumuna göre
28-30-32mm
kalınlıkta camlar için kombinasyon
**outside glass 6mm
depending on the situation
combination for 28-30-32mm glass**

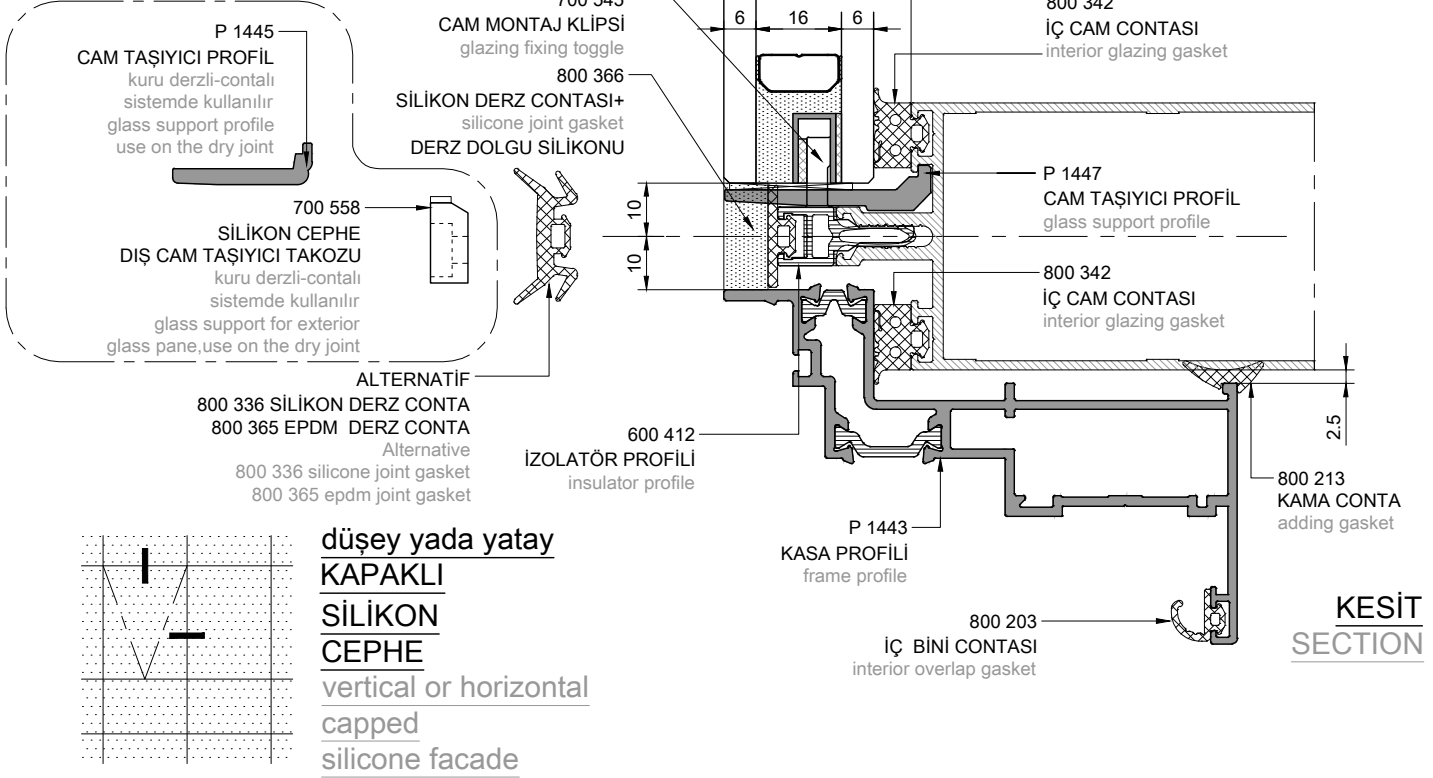

**düşey yada yatay
KAPAKLI
SİLİKON
CEPHE**
vertical or horizontal
capped
silicone facade

Sayfada bulunan tüm veriler teoriktir.
Lütfen cam ve conta toleranslarını dikkate alınız.
All data on the page are theoretical.
Please consider the glass and gasket tolerance

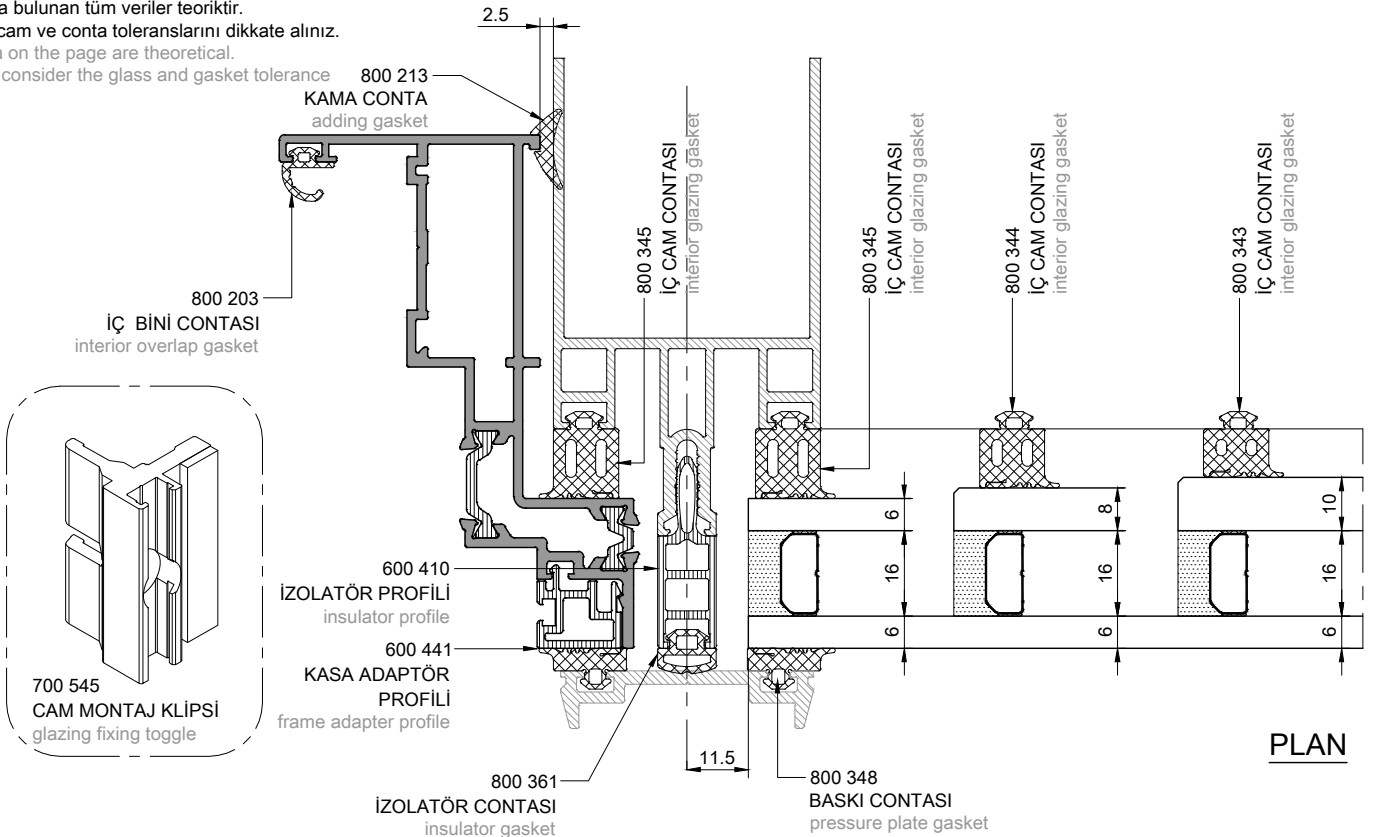

****dış cam 8mm**
olması durumuna göre
30-32-34mm
kalınlıkta camlar için kombinasyon
****outside glass 8mm**
depending on the situation
combination for 30-30-34mm glass

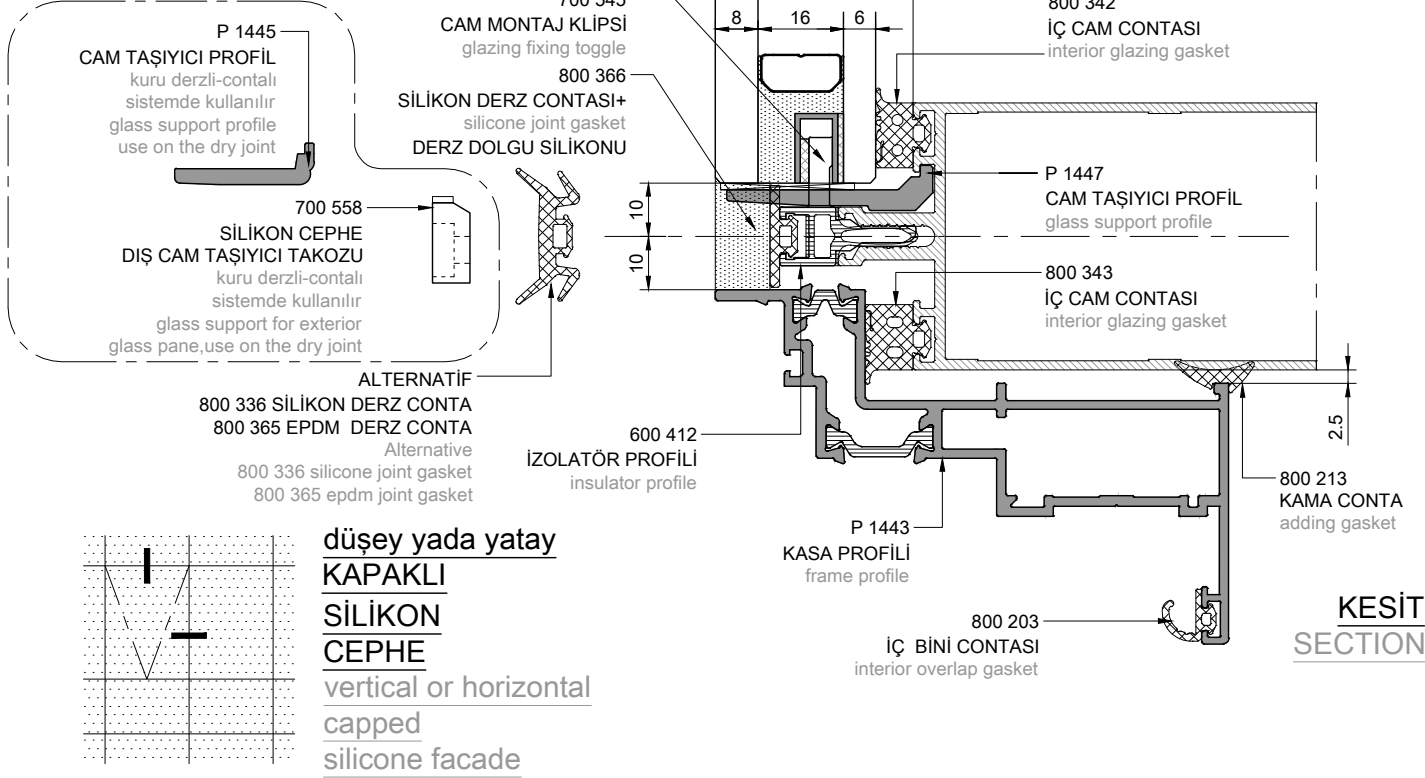

KESİT
SECTION

düşey yada yatay
KAPAKLI
SİLİKON
CEPHE
vertical or horizontal
capped
silicone facade

Sayfada bulunan tüm veriler teoriktir.
Lütfen cam ve conta toleranslarını dikkate alınız.
All data on the page are theoretical.
Please consider the glass and gasket tolerance

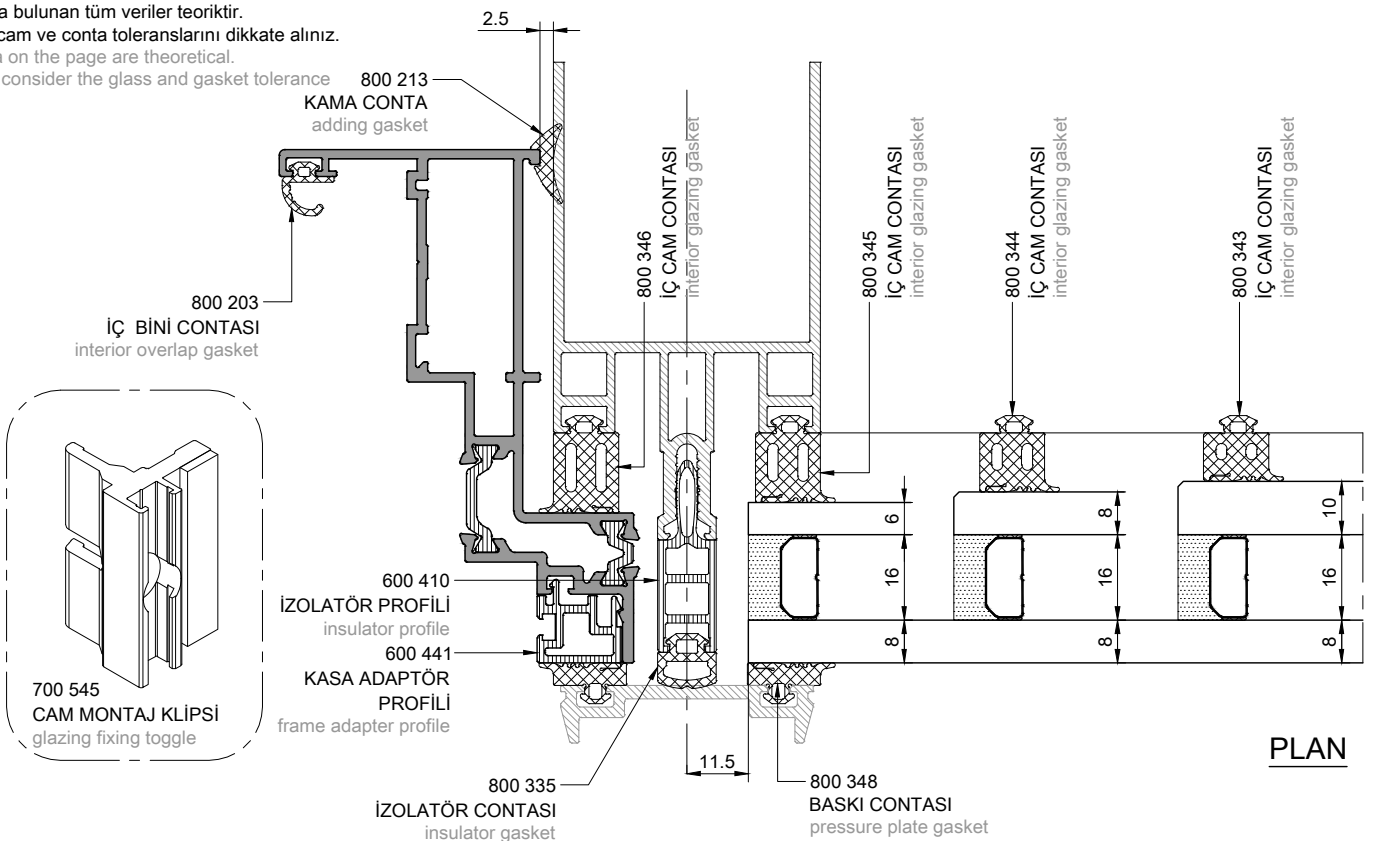

PLAN

****dış cam 6mm**
olması durumuna göre
34-36-38mm
kalınlıkta camlar için kombinasyon
****outside glass 6mm**
depending on the situation
combination for 34-36-38mm glass

P 1445
CAM TAŞIYICI PROFİL
 kuru derzli-contalı
 sistemde kullanılır
 glass support profile
 use on the dry joint

700 558
SİLİKON CEPHE
DIŞ CAM TAŞIYICI TAKOZU
 kuru derzli-contalı
 sistemde kullanılır
 glass support for exterior
 glass pane, use on the dry joint

ALTERNATİF
800 336 SİLİKON DERZ CONTA
800 365 EPDM DERZ CONTA
 Alternative
 800 336 silicone joint gasket
 800 365 epdm joint gasket

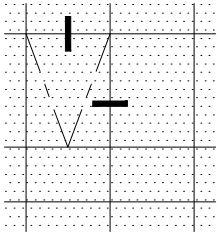

düşey yada yatay
KAPAKLI
SİLİKON
CEPHE
 vertical or horizontal
 capped
 silicone facade

Sayfada bulunan tüm veriler teoriktir.
 Lütfen cam ve conta toleranslarını dikkate alınız.
 All data on the page are theoretical.
 Please consider the glass and gasket tolerance

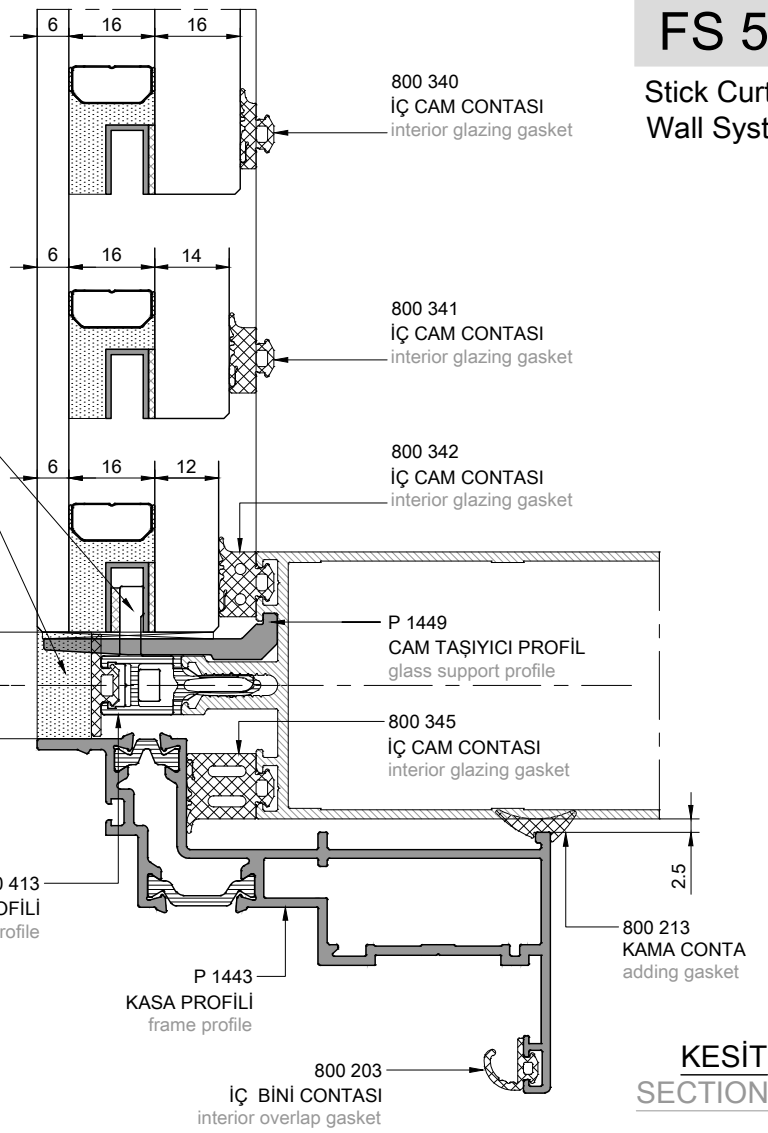

KESİT
SECTION

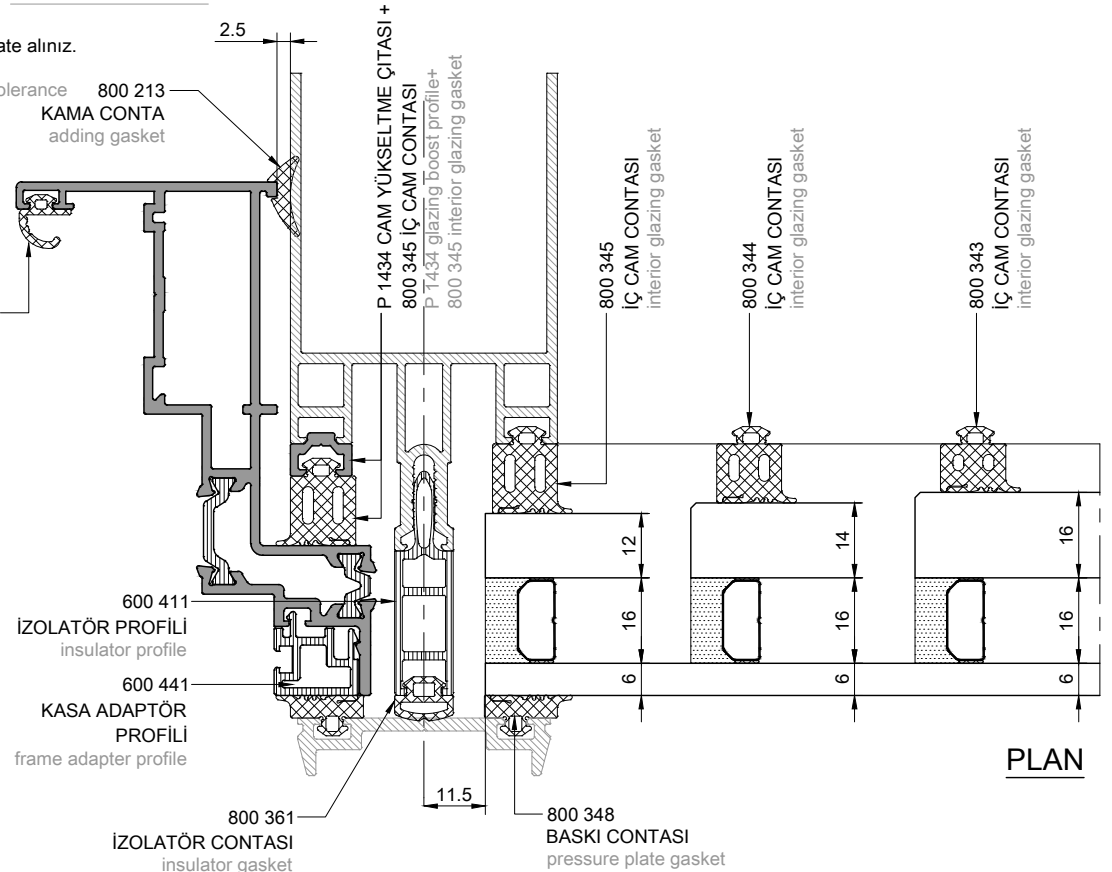
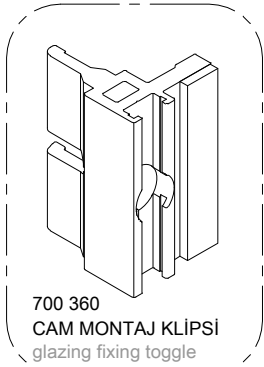

PLAN

****dış cam 8mm**
olması durumuna göre
36-38-40mm
kalınlıkta camlar için kombinasyon
****outside glass 8mm**
depending on the situation
combination for 36-38-40mm glass

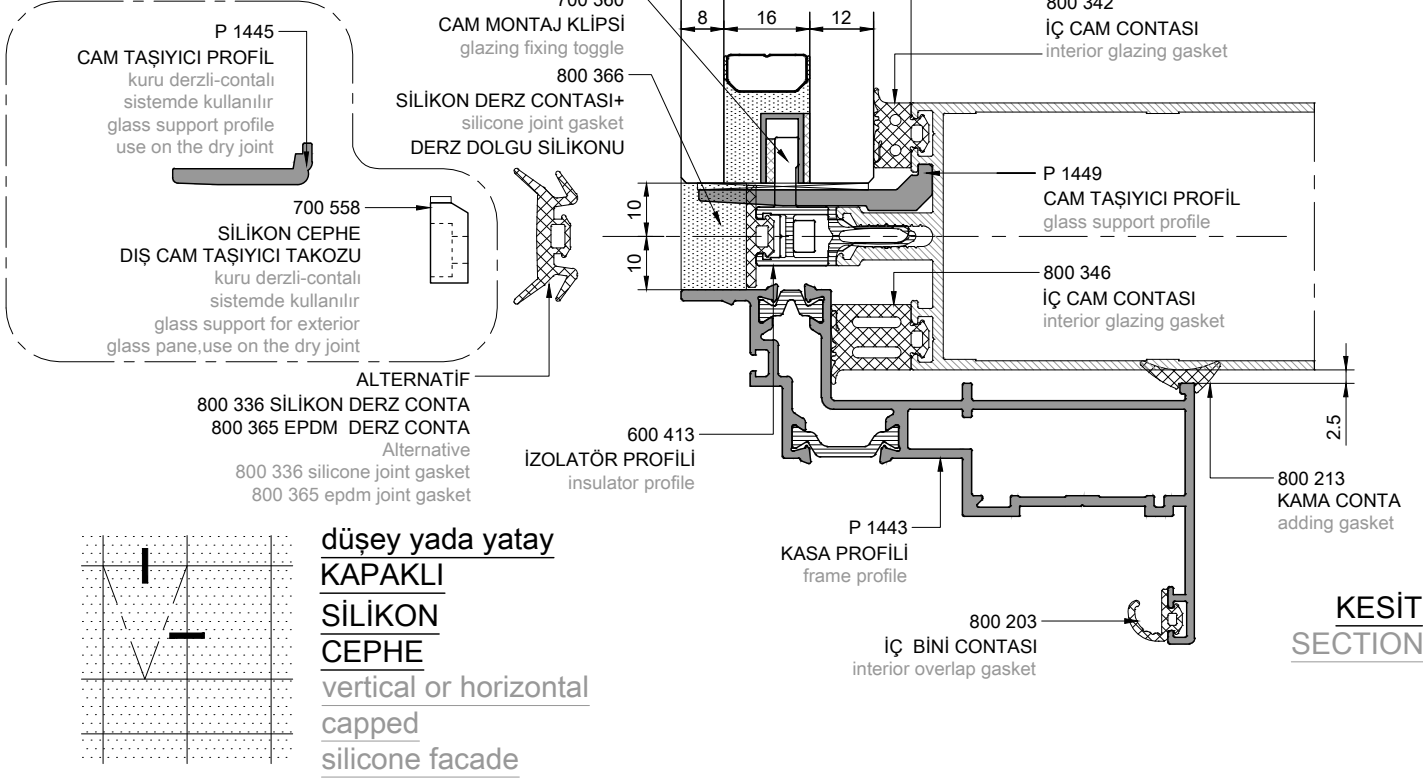

KESİT SECTION

Sayfada bulunan tüm veriler teoriktir.
Lütfen cam ve conta toleranslarını dikkate alınız.
All data on the page are theoretical.
Please consider the glass and gasket tolerance

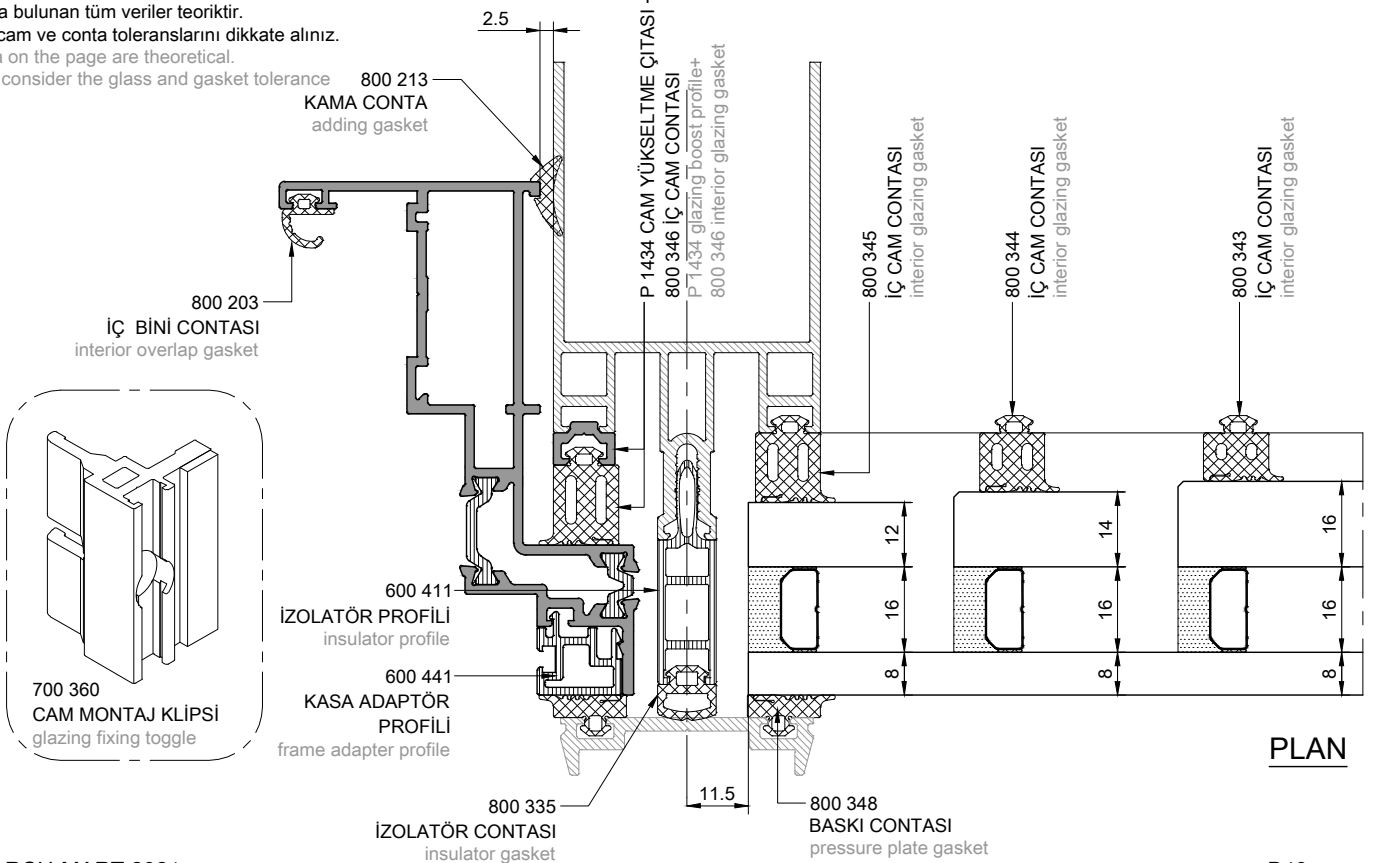

FS 50
STICK GİYDİRME CEPHE SİSTEMİ
STICK CURTAIN WALL SYSTEM

YATAY yada DÜŞEY KAPAKLI
SİLİKON CEPHE
(CAM İÇİ ALUMİNYUM SPACER)
CAM KOMBİNASYONLARI
HORIZONTAL OR VERTICAL CAPPED
SILICONE FACADE
(INSIDE GLASS ALUMINIUM SPACER)
GLASS COMBINATIONS

****dış cam 6mm**
olması durumuna göre
32-34-36mm
kalınlıkta camlar için kombinasyon
****outside glass 6mm**
depending on the situation
combination for 32-34-36mm glass

P 1445
CAM TAŞIYICI PROFİL
kuru derzli-contalı
sistemde kullanılır
glass support profile
use on the dry joint

700 558
SİLİKON CEPHE
DIŞ CAM TAŞIYICI TAKOZU
kuru derzli-contalı
sistemde kullanılır
glass support for exterior
glass pane, use on the dry joint

ALTERNATİF
800 336 SİLİKON DERZ CONTA
800 365 EPDM DERZ CONTA
Alternative
800 336 silicone joint gasket
800 365 epdm joint gasket

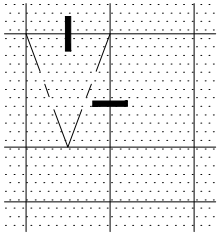

düşey yada yatay
KAPAKLI
SİLİKON
CEPHE
vertical or horizontal
capped
silicone facade

Sayfada bulunan tüm veriler teoriktir.
Lütfen cam ve conta toleranslarını dikkate alınız.
All data on the page are theoretical.
Please consider the glass and gasket tolerance

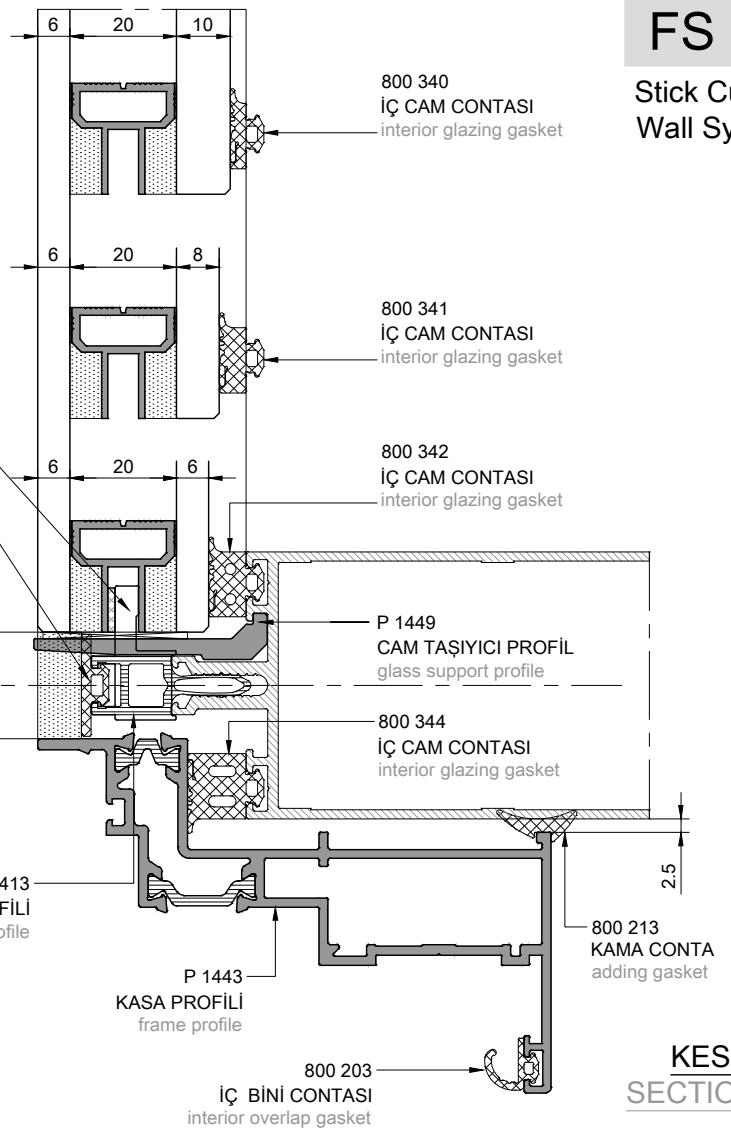

KESİT
SECTION

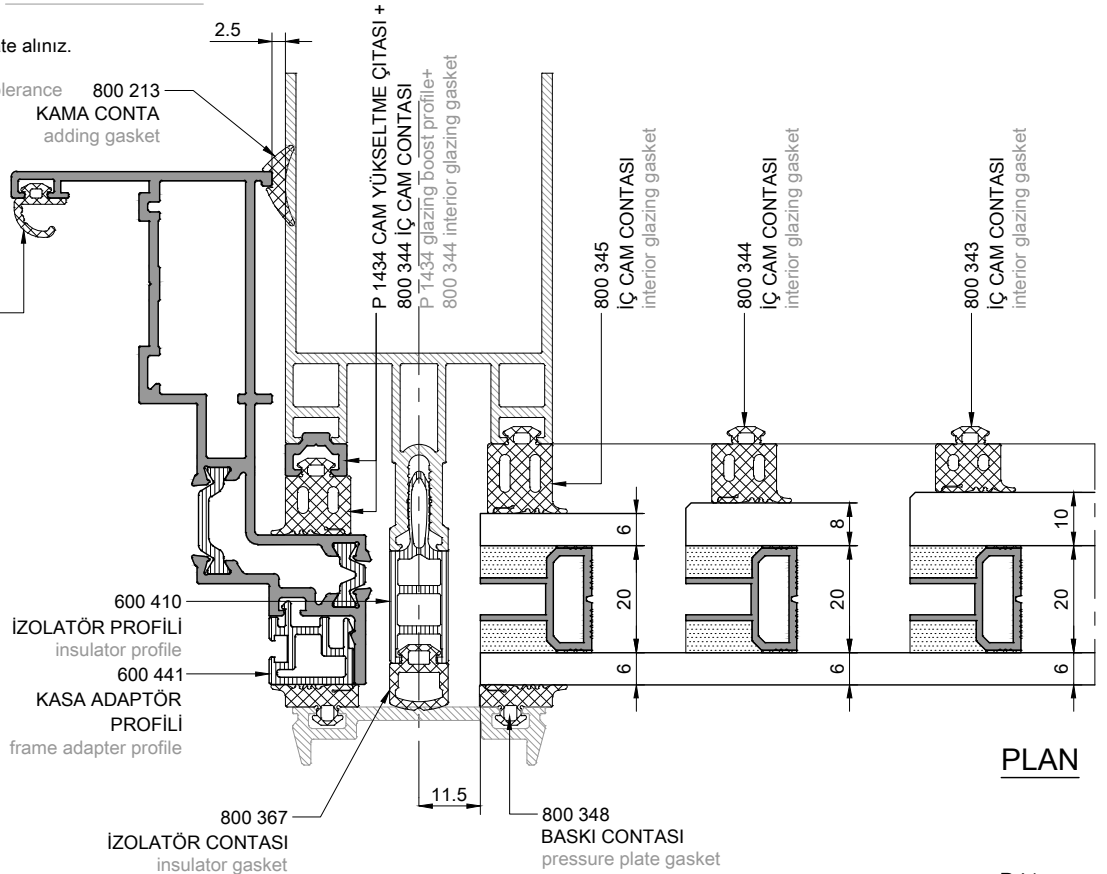
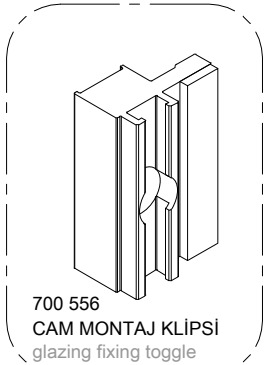

PLAN

****dış cam 8mm**
olması durumuna göre
34-36-38mm
kalınlıkta camlar için kombinasyon
****outside glass 8mm**
depending on the situation
combination for 34-36-38mm glass

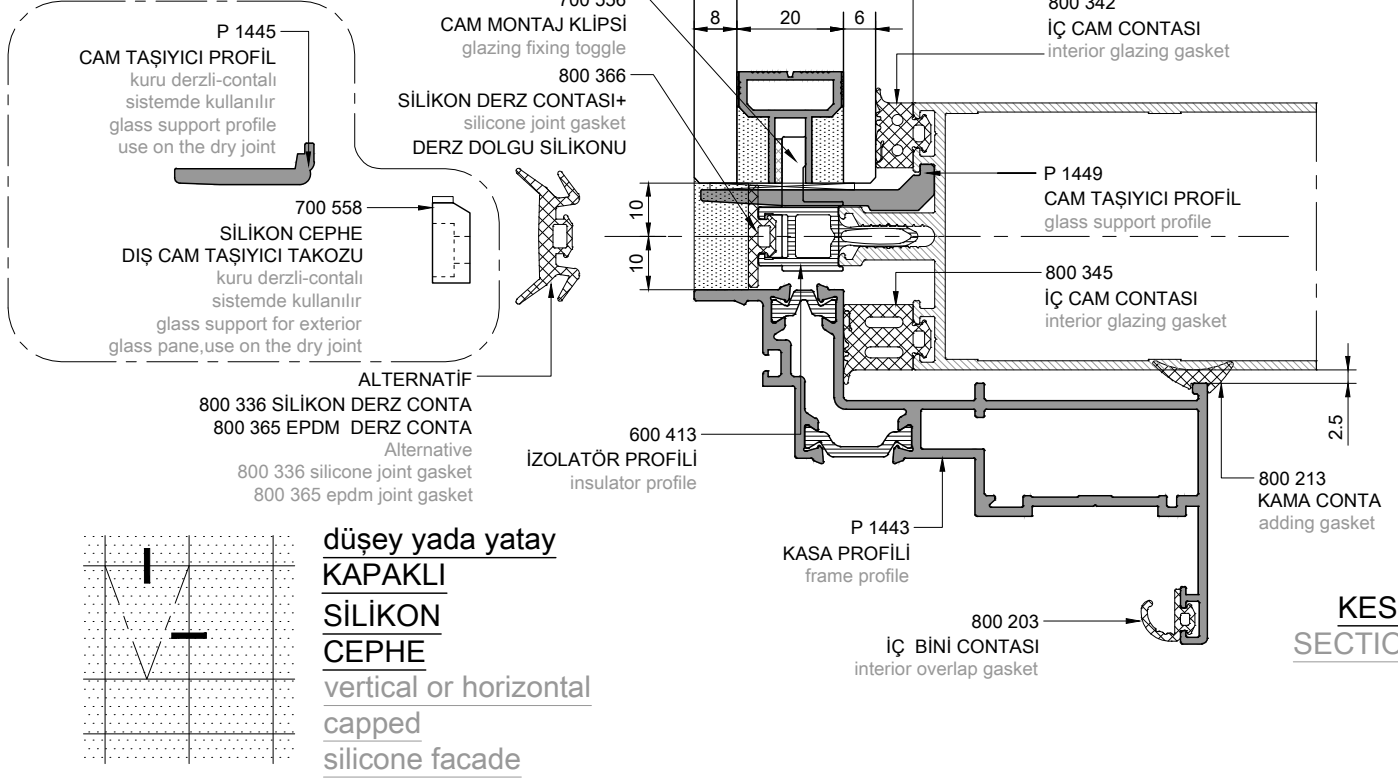

**KESİT
SECTION**

**düşey yada yatay
KAPAKLI
SİLİKON
CEPHE**
vertical or horizontal
capped
silicone facade

Sayfada bulunan tüm veriler teoriktir.
Lütfen cam ve conta toleranslarını dikkate alınız.
All data on the page are theoretical.
Please consider the glass and gasket tolerance

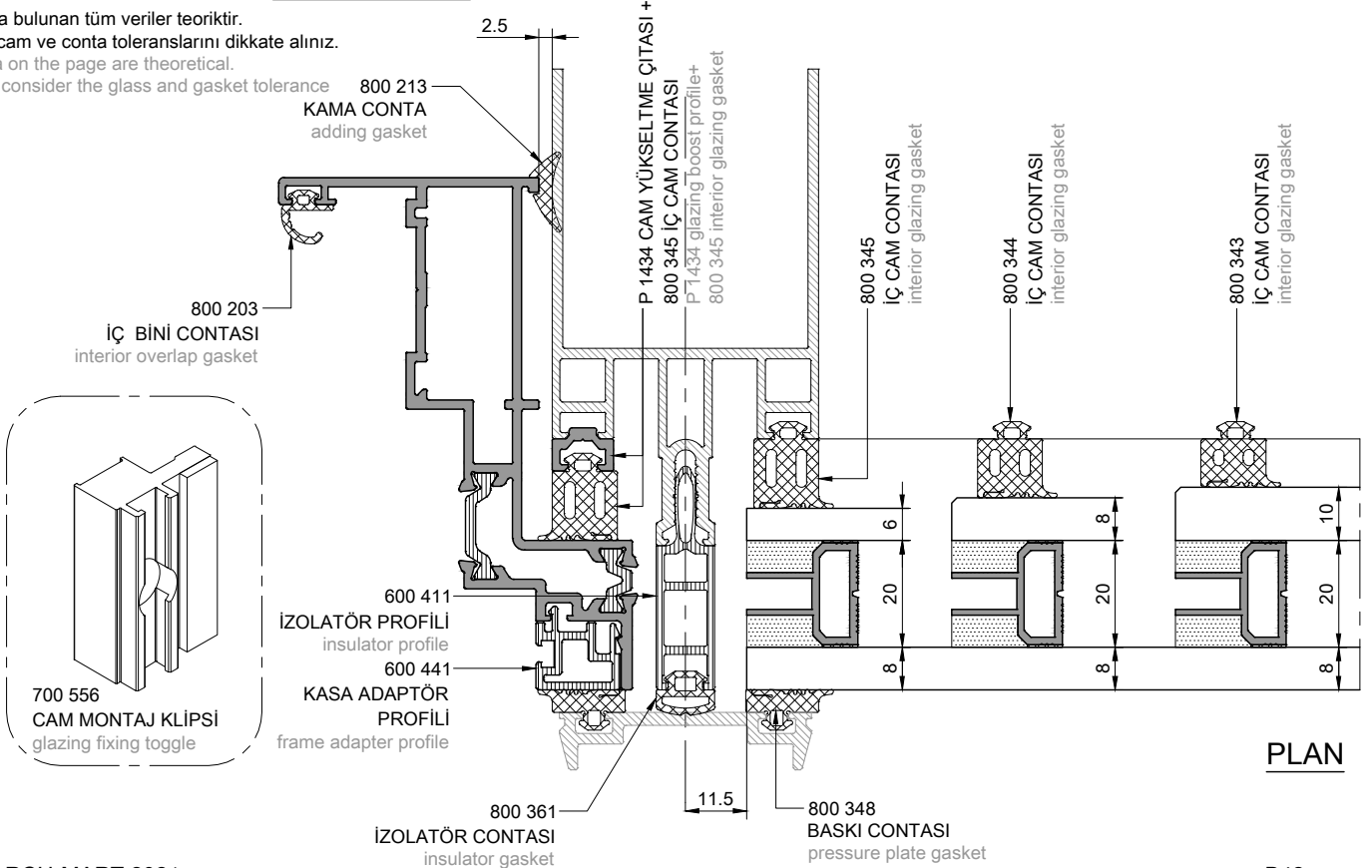

PLAN

****dış cam 6mm**
olması durumuna göre
38-40-42mm
kalınlıkta camlar için kombinasyon
****outside glass 6mm**
depending on the situation
combination for 38-40-42mm glass

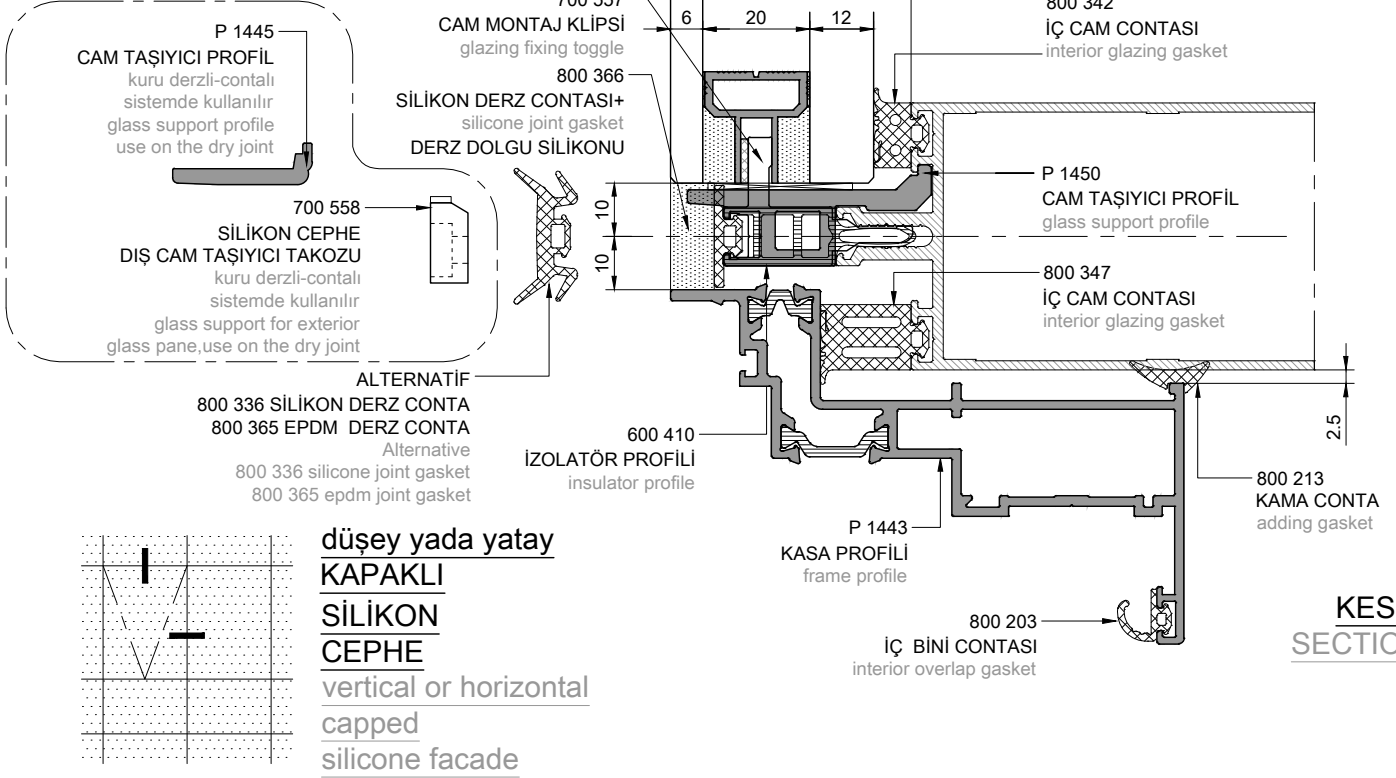

düşey yada yatay
KAPAKLI
SİLİKON
CEPHE
vertical or horizontal
capped
silicone facade

Sayfada bulunan tüm veriler teoriktir.
Lütfen cam ve conta toleranslarını dikkate alınız.
All data on the page are theoretical.
Please consider the glass and gasket tolerance

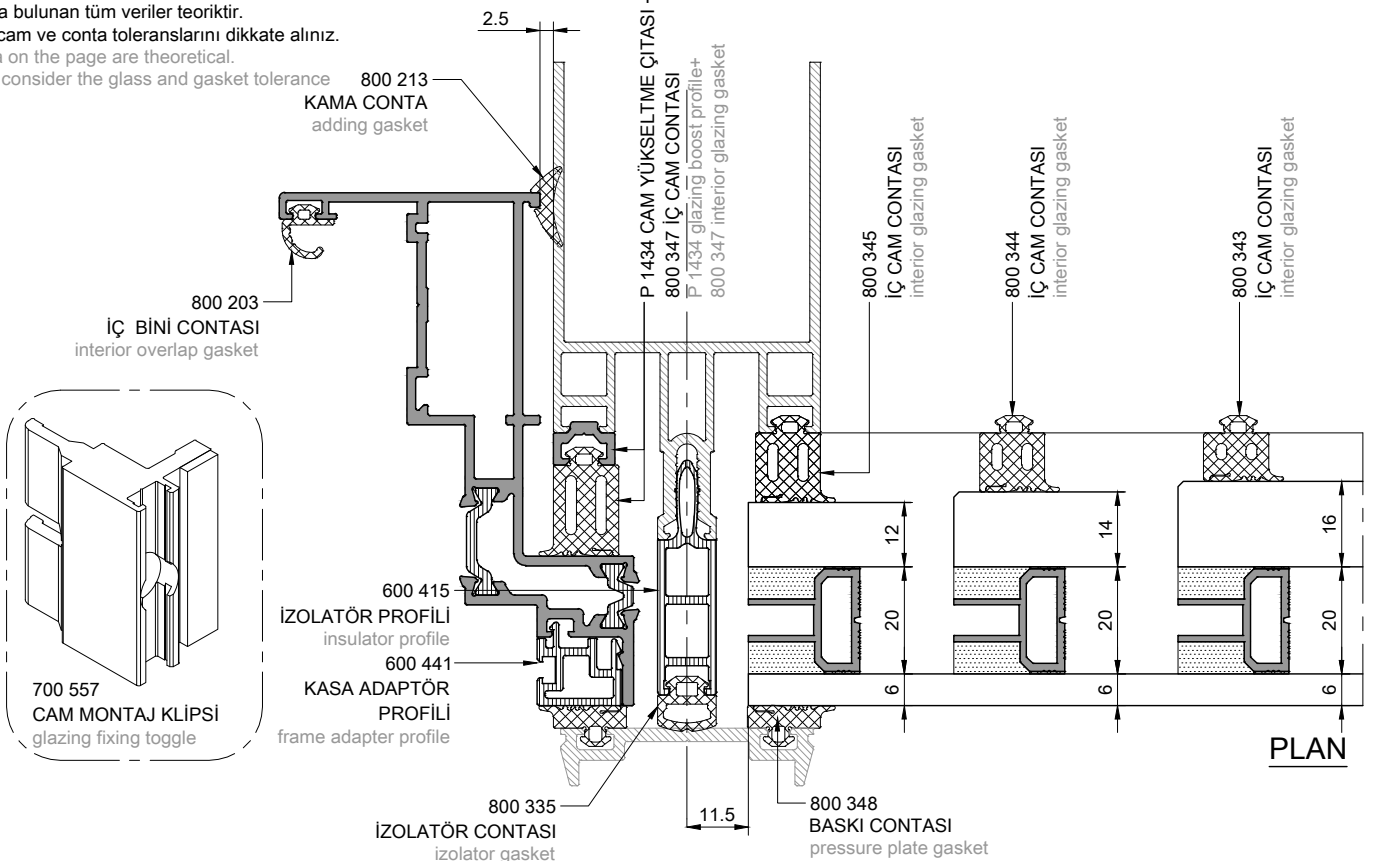

****dış cam 8mm**
olması durumuna göre
40-42-44mm
kalınlıkta camlar için kombinasyon
****outside glass 8mm**
depending on the situation
combination for 40-42-44mm glass

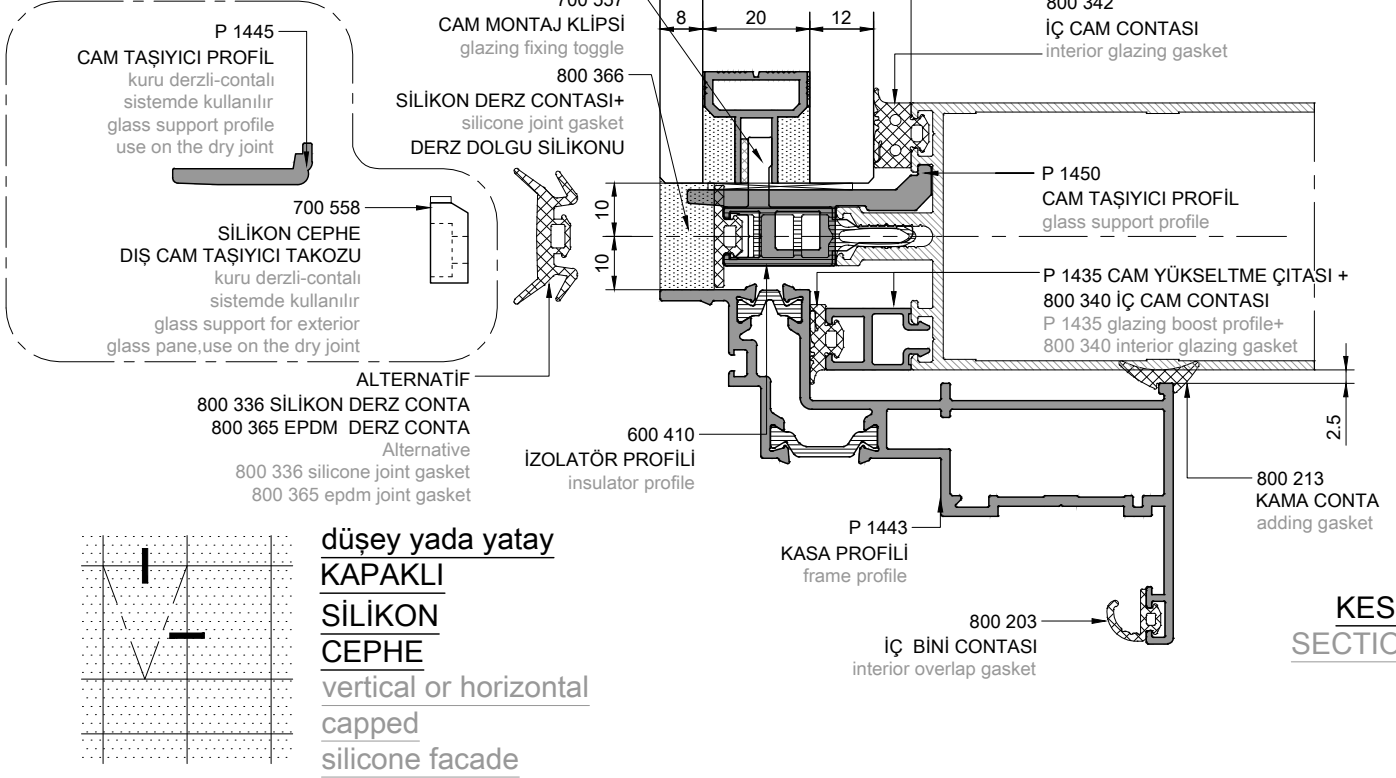





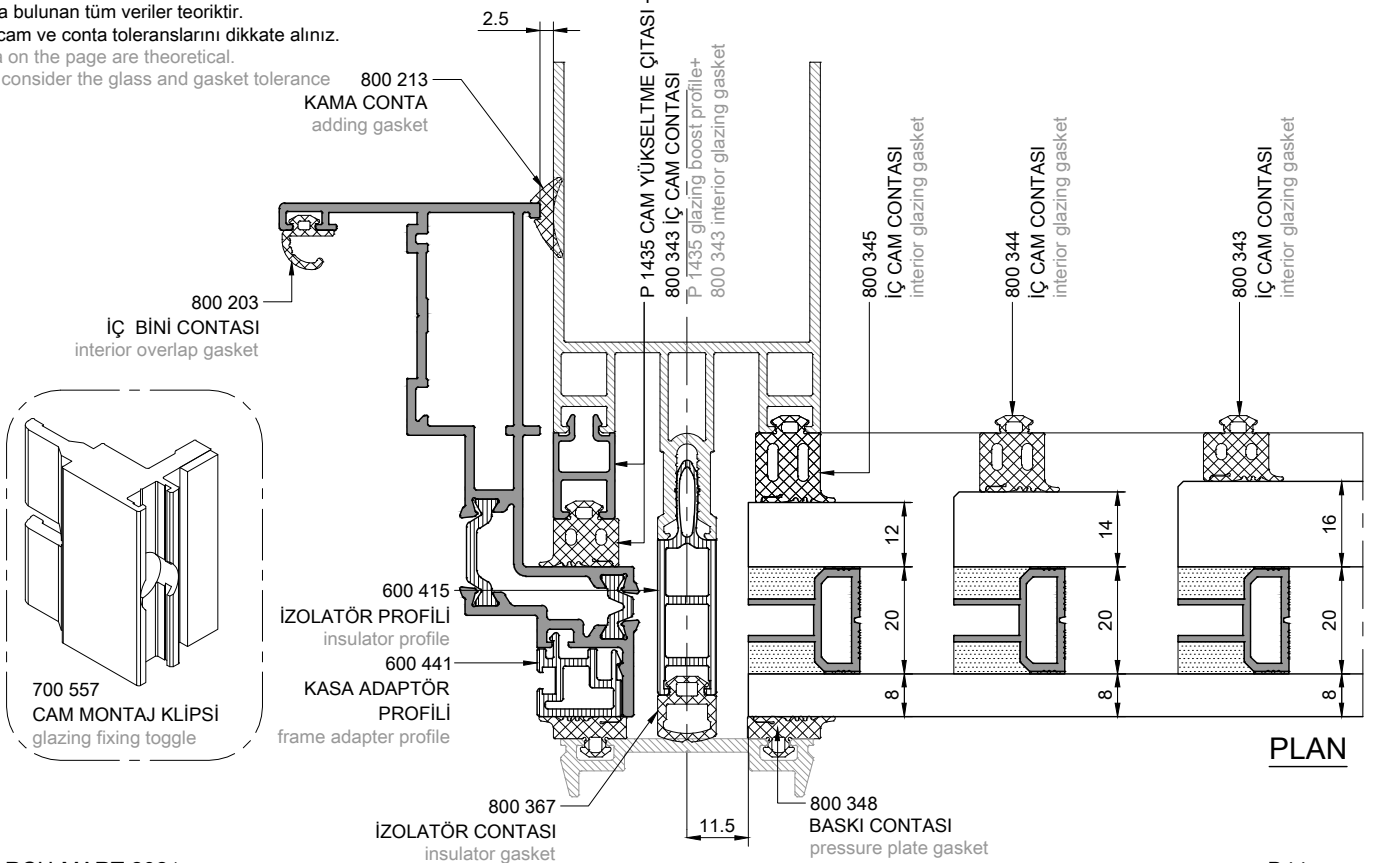





**KESİT
SECTION**











Sayfada bulunan tüm veriler teoriktir.
Lütfen cam ve conta toleranslarını dikkate alınız.
All data on the page are theoretical.
Please consider the glass and gasket tolerance























FS50
STICK GİYDİRME CEPHE SİSTEMİ
STICK CURTAIN WALL SYSTEM



CONTALAR
GASKETS

CONTA ŞEKLİ GASKET SECTION	CONTA KODU GASKET NO	MALZEME MATERIAL	CONTA TANIMI GASKET DESCRIPTION	PAKET PACKAGE
	800 202	EPDM	KANAT BİNİ CONTASI overlap gasket for sash	115mt/paket 0,130kg/mt
	800 203	EPDM	İÇ BİNİ CONTASI interior overlap gasket	300mt/paket 0,046kg/mt
	800 213	EPDM	(2,5mm) KAMA CONTA adding gasket	326mt/paket 0,046kg/mt
	800 228	EPDM	(4mm) KAMA CONTA adding gasket	185mt/paket 0,081kg/mt
	800 332	EPDM	DIŞ BİNİ CONTASI exterior overlap gasket	370mt/paket 0,027kg/mt
	800 335	EPDM	İZOLATÖR CONTASI insulator gasket	208mt/paket 0,072kg/mt
	800 367	EPDM	İZOLATÖR CONTASI insulator gasket	188mt/paket 0,080kg/mt
	800 361	EPDM	İZOLATÖR CONTASI insulator gasket	263mt/paket 0,057kg/mt
	800 366	SİLİKON	SİLİKON DERZ CONTASI silicone joint gasket	100mt/paket 0,075kg/mt
	800 336	SİLİKON	SİLİKON DERZ CONTASI silicone joint gasket	100mt/paket 0,165kg/mt

CONTA ŞEKLİ GASKET SECTION	CONTA KODU GASKET NO	MALZEME MATERIAL	CONTA TANIMI GASKET DESCRIPTION	PAKET PACKAGE
	800 365	EPDM	EPDM DERZ CONTASI EPDM joint gasket	100mt/paket 0,130kg/mt
	800 340	EPDM	3mm İÇ CAM CONTASI 3mm interior glazing gasket	234mt/paket 0,064kg/mt
	800 341	EPDM	5mm İÇ CAM CONTASI 5mm interior glazing gasket	156mt/paket 0,096kg/mt
	800 342	EPDM	7mm İÇ CAM CONTASI 7mm interior glazing gasket	125mt/paket 0,120kg/mt
	800 343	EPDM	9mm İÇ CAM CONTASI 9mm interior glazing gasket	103mt/paket 0,146kg/mt
	800 344	EPDM	11mm İÇ CAM CONTASI 11mm interior glazing gasket	90mt/paket 0,167kg/mt
	800 345	EPDM	13mm İÇ CAM CONTASI 13mm interior glazing gasket	79mt/paket 0,189kg/mt
	800 346	EPDM	15mm İÇ CAM CONTASI 15mm interior glazing gasket	71mt/paket 0,210kg/mt
	800 347	EPDM	17mm İÇ CAM CONTASI 17mm interior glazing gasket	65mt/paket 0,231kg/mt
	800 348	EPDM	BASKI PROFİLİ CONTASI pressure plate gasket	176mt/paket 0,085kg/mt







CONTA ŞEKLİ GASKET SECTION	CONTA KODU GASKET NO	MALZEME MATERIAL	CONTA TANIMI GASKET DESCRIPTION	PAKET PACKAGE
	800 349	EPDM	0,8mm İÇ CAM CONTASI 0,8mm interior glazing gasket	448mt/paket 0,029kg/mt
	800 350	EPDM	2,8mm İÇ CAM CONTASI 2,8mm interior glazing gasket	268mt/paket 0,056kg/mt
	800 351	EPDM	4,8mm İÇ CAM CONTASI 4,8mm interior glazing gasket	183mt/paket 0,082kg/mt
	800 352	EPDM	6,8mm İÇ CAM CONTASI 6,8mm interior glazing gasket	139mt/paket 0,108kg/mt
	800 353	EPDM	8,8mm İÇ CAM CONTASI 8,8mm interior glazing gasket	113mt/paket 0,133kg/mt
	800 354	EPDM	4mm İÇ CAM CONTASI 4mm interior glazing gasket	211mt/paket 0,071kg/mt
	800 355	EPDM	6mm İÇ CAM CONTASI 6mm interior glazing gasket	155mt/paket 0,097kg/mt
	800 356	EPDM	8mm İÇ CAM CONTASI 8mm interior glazing gasket	124mt/paket 0,121kg/mt
	800 357	EPDM	10mm İÇ CAM CONTASI 10mm interior glazing gasket	105mt/paket 0,143kg/mt
	800 358	EPDM	12mm İÇ CAM CONTASI 12mm interior glazing gasket	92mt/paket 0,163kg/mt

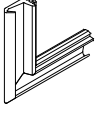
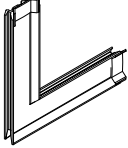
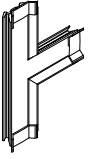
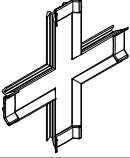

CONTA ŞEKLİ GASKET SECTION	CONTA KODU GASKET NO	MALZEME MATERIAL	CONTA TANIMI GASKET DESCRIPTION	PAKET PACKAGE
	800 359	EPDM	14mm İÇ CAM CONTASI 14mm interior glazing gasket	82mt/paket 0,182kg/mt
	800 360	EPDM	16mm İÇ CAM CONTASI 16mm interior glazing gasket	74mt/paket 0,202kg/mt
	800 362	EPDM	DAMLALIK CONTASI dropper gasket	234mt/paket 0,064kg/mt
	800 363	EPDM	KASA KANAL CONTASI channel closing gasket	600mt/paket 0,012kg/mt
	800 364	EPDM	YARIM DÜŞEY PROFİL SIZDIRMAZLIK CONTASI tightness gasket for male mullion	600mt/paket 0,020kg/mt
	800 288	EPDM	CEPHE ADAPTÖR BESLEME CONTASI adding gasket facade adapter	230mt/paket 0,065kg/mt
	800 289	EPDM	CEPHE ADAPTÖR BESLEME CONTASI adding gasket facade adapter	134mt/paket 0,112kg/mt
	800 290	EPDM	CEPHE ADAPTÖR BESLEME CONTASI adding gasket facade adapter	95mt/paket 0,158kg/mt
	800 291	EPDM	CEPHE ADAPTÖR BESLEME CONTASI adding gasket facade adapter	80mt/paket 0,186kg/mt
	800 292	EPDM	CEPHE ADAPTÖR BESLEME CONTASI adding gasket facade adapter	68mt/paket 0,218kg/mt





CONTA ŐEKLİ GASKET SECTION	CONTA KODU GASKET NO	MALZEME MATERIAL	CONTA TANIMI GASKET DESCRIPTION	PAKET PACKAGE
	800 272	EPDM	YARIM DÜŐEY PROFİL SIZDIRMAZLIK CONTASI tightness gasket	415mt/paket 0,036kg/mt
	800 234	EPDM	Ø4mm YUVARLAK CONTA oring gasket	500mt/paket 0,017kg/mt

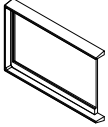
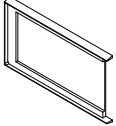
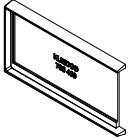
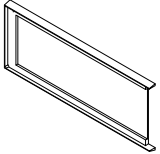
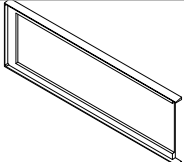

FS50
STICK GİYDİRME CEPHE SİSTEMİ
STICK CURTAIN WALL SYSTEM

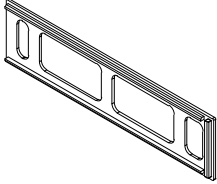
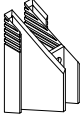
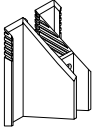
AKSESUARLAR
ACCESSORIES

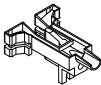
AKSESUAR ŞEKLİ ACCESSORIES SHAPE	AKSESUAR ACCESS. NO	AKSESUAR TANIMI ACCESSORIES DESCRIPTION	MİKTAR QUANTITY
	700 301	VULKANİZE KÖŞE PARÇA vulcanize corner piece	50 adet/pieces
	700 522	VULKANİZE KÖŞE PARÇA vulcanize corner piece	50 adet/pieces
	700 523	VULKANİZE KÖŞE PARÇA vulcanize corner piece	50 adet/pieces
	700 524	VULKANİZE KÖŞE PARÇA vulcanize corner piece	50 adet/pieces
	700 303	PVC ONBAŞI pvc corner angle	500 adet/pieces
	700 342	U KANAL u channel	500 adet/pieces
	700 359	ALUMİNYUM SPACER aluminium spacer	6mtX100ad. adet/pieces
	700 360	CAM MONTAJ KLİPSİ glazing fixing toggle	100 adet/pieces
	700 545	CAM MONTAJ KLİPSİ glazing fixing toggle	100 adet/pieces
	700 556	CAM MONTAJ KLİPSİ glazing fixing toggle	100 adet/pieces

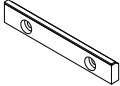
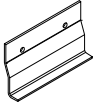
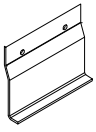
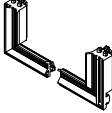
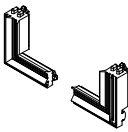
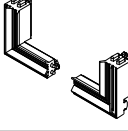
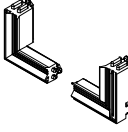
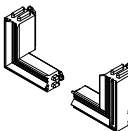

AKSESUAR ŞEKLİ ACCESSORIES SHAPE	AKSESUAR ACCESS. NO	AKSESUAR TANIMI ACCESSORIES DESCRIPTION	MİKTAR QUANTITY
	700 557	CAM MONTAJ KLİPSİ glazing fixing toggle	100 adet/pieces
	700 361	ALUMİNYUM SPACER İÇİN KÖŞE ONBAŞI corner cleat for aluminium spacer	100 adet/pieces
	700 362	BUTONLU YATAY PROFİL MONTAJ TAKOZU button support for transom	250 adet/pieces
	700 461	60mm YAKA CONTASI connector gasket	250 adet/pieces
	700 552	85mm YAKA CONTASI connector gasket	250 adet/pieces
	700 550	95mm YAKA CONTASI connector gasket	250 adet/pieces
	700 460	105mm YAKA CONTASI connector gasket	250 adet/pieces
	700 549	110mm YAKA CONTASI connector gasket	250 adet/pieces
	700 548	135mm YAKA CONTASI connector gasket	250 adet/pieces
	700 551	160mm YAKA CONTASI connector gasket	250 adet/pieces

AKSESUAR ŞEKLİ ACCESSORIES SHAPE	AKSESUAR ACCESS. NO	AKSESUAR TANIMI ACCESSORIES DESCRIPTION	MİKTAR QUANTITY
	700 564	165mm YAKA CONTASI connector gasket	250 adet/pieces
	700 865	165mm YAKA CONTASI connector gasket	250 adet/pieces
	700 866	200mm YAKA CONTASI connector gasket	250 adet/pieces
	700 540	EK YERİ PARÇASI mullion splice piece	50 adet/pieces
	700 541	EK YERİ PARÇASI mullion splice piece	50 adet/pieces
	700 542	TAHLİYE UZATMA PARÇASI drainage piece extending	50 adet/pieces
	700 543	SU TAHLİYE PARÇASI water drainage piece	50 adet/pieces
	700 544	SU TAHLİYE PARÇASI water drainage piece	50 adet/pieces
	700 553	Ø8x50 INOX PIN Ø8x50 stainless steel pin	100 adet/pieces

AKSESUAR ŞEKLİ ACCESSORIES SHAPE	AKSESUAR ACCESS. NO	AKSESUAR TANIMI ACCESSORIES DESCRIPTION	MİKTAR QUANTITY
	700 554	Ø8x30 YARIM INOX PIN Ø8x30 half stainless steel pin	100 adet/pieces
	800 245	YATAY-DÜŞEY PROFİL BİRLEŞİM SIZDIRMAZLIK CONTASI tightness gasket	100 adet/pieces
	700 558	SİLİKON CEPHE DIŞCAM TAŞIYICI CAM TAKOZU glass support for exterior glass pane	100 adet/pieces
	700 546	DIŞ CAM TAŞIYICI glass support for exterior glass pane	50 adet/pieces
	700 547	DIŞ CAM TAŞIYICI glass support for exterior glass pane	50 adet/pieces
	700 559	VULKANİZE KÖŞE CONTA (sağ/sol) vulcanize corner gasket piece(right/left)	25 takım/set
	700 560	VULKANİZE KÖŞE CONTA (sağ/sol) vulcanize corner gasket piece(right/left)	25 takım/set
	700 561	VULKANİZE KÖŞE CONTA (sağ/sol) vulcanize corner gasket piece(right/left)	25 takım/set
	700 562	VULKANİZE KÖŞE CONTA (sağ/sol) vulcanize corner gasket piece(right/left)	25 takım/set
	700 563	VULKANİZE KÖŞE CONTA (sağ/sol) vulcanize corner gasket piece(right/left)	25 takım/set

FS50
STICK GİYDİRME CEPHE SİSTEMİ
STICK CURTAIN WALL SYSTEM

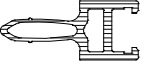
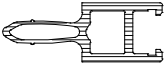
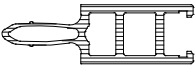
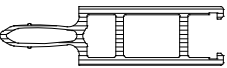
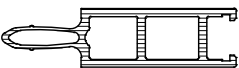
PVC İZOLATÖR PROFİLLER
PVC INSULATOR PROFILE

PROFİL ŞEKLİ PROFILE SECTION	PROFİL ADI PROFILE NO	MALZEME MATERIAL	PROFİL TANIMI PROFILE DESCRIPTION	PAKET PACKAGE
 0,115kg/mt	600 412	PVC	11mm İZOLATÖR PROFİLİ 11mm insulator profile	6mt 25ad/piece
 0,130kg/mt	600 413	PVC	15mm İZOLATÖR PROFİLİ 15mm insulator profile	6mt 25ad/piece
 0,175kg/mt	600 410	PVC	21mm İZOLATÖR PROFİLİ 21mm insulator profile	6mt 25ad/piece
 0,200kg/mt	600 411	PVC	27mm İZOLATÖR PROFİLİ 27mm insulator profile	6mt 25ad/piece
 0,210kg/mt	600 415	PVC	29mm İZOLATÖR PROFİLİ 29mm insulator profile	6mt 25ad/piece
 0,065kg/mt	600 440	PVC	KAYMA ÖNLEYİCİ PROFİLİ anti slip profile	6mt 25ad/piece
 0,130kg/mt	600 441	PVC	VASİSTAS PENCERE KASA ADAPTÖRÜ adapter for top hung window frame	6mt 25ad/piece

FS50
STICK GİYDİRME CEPHE SİSTEMİ
STICK CURTAIN WALL SYSTEM

TAM ÖLÇEKLİ ALUMİNYUM PROFİLLER
FULL SCALE ALUMINIUM PROFILES

P 1380

18mm DÜŞEY PROFİL

18mm mullion profile

Ağırlık/Weight : 1,175 kg/mt

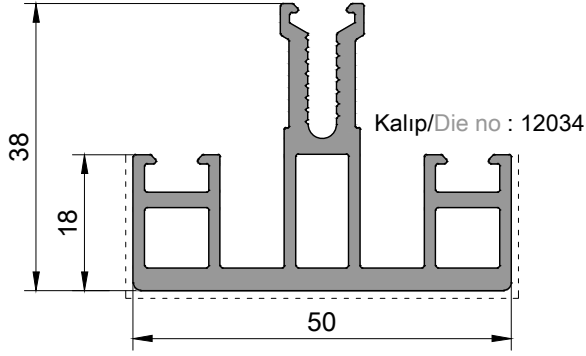

lx : 8.39 cm⁴
ly : 4.65 cm⁴
Wx : 3.17 cm³
Wy : 1.86 cm³

P 1381

80mm DÜŞEY PROFİL

80mm mullion profile

Ağırlık/Weight : 2,160 kg/mt

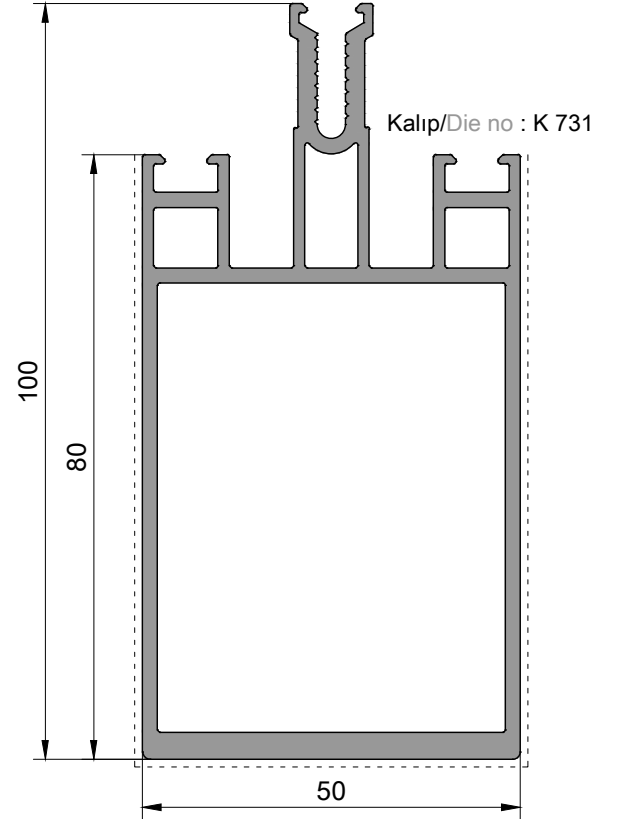

lx : 81.84 cm⁴
ly : 24.79 cm⁴
Wx : 15.18 cm³
Wy : 9.91 cm³

P 1382

90mm DÜŞEY PROFİL

90mm mullion profile

Ağırlık/Weight : 2,145 kg/mt

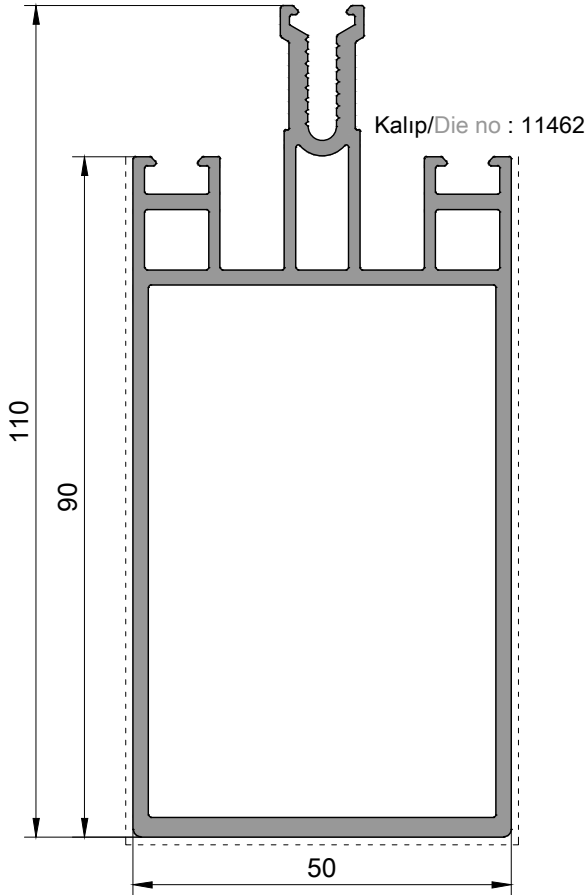

Ix : 95.47 cm⁴
Iy : 26.29 cm⁴
Wx : 17.20 cm³
Wy : 10.51 cm³

P 1383

90° DÜŞEY KÖŞE PROFİL

90° mullion corner profile

Ağırlık/Weight : 2,835 kg/mt

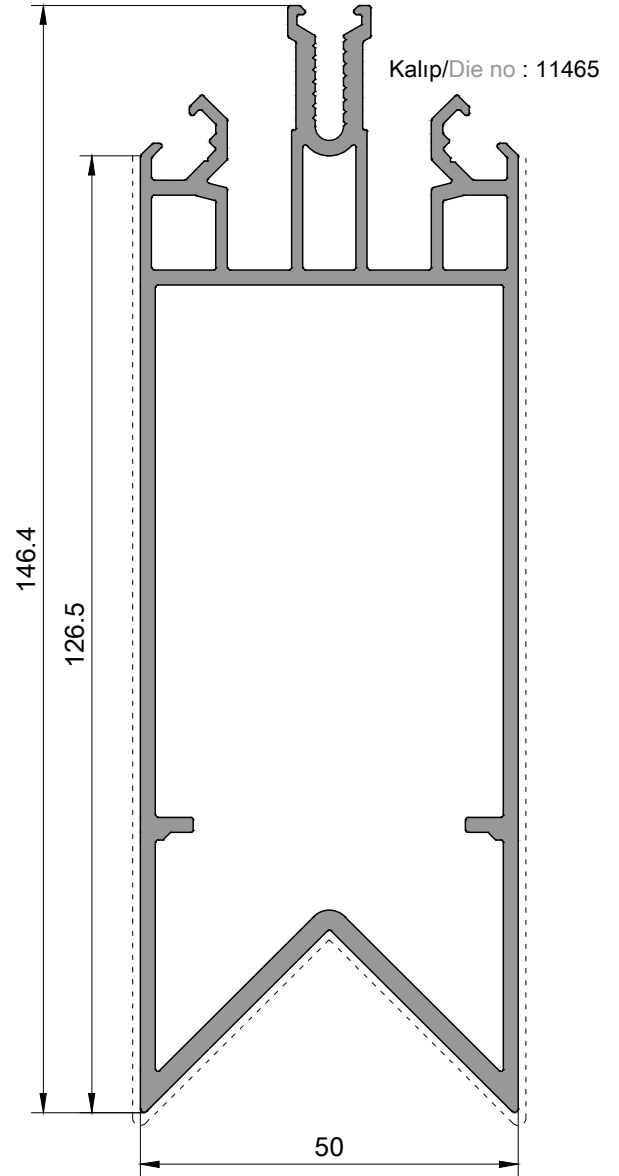

Ix : 224.16 cm⁴
Iy : 37.57 cm⁴
Wx : 29.84 cm³
Wy : 15.03 cm³

P 1384

100mm DÜŞEY PROFİL

100mm mullion profile

Ağırlık/Weight : 1,855 kg/mt

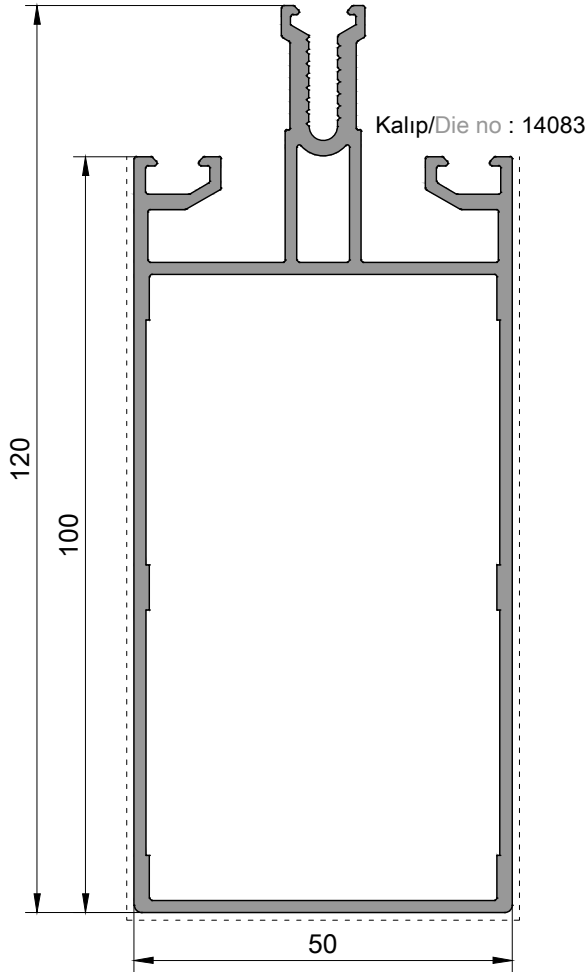

Ix : 98.49 cm⁴
Iy : 24.27 cm⁴
Wx : 15.48 cm³
Wy : 9.71 cm³

P 1385

105mm DÜŞEY PROFİL

105mm mullion profile

Ağırlık/Weight : 2,430 kg/mt

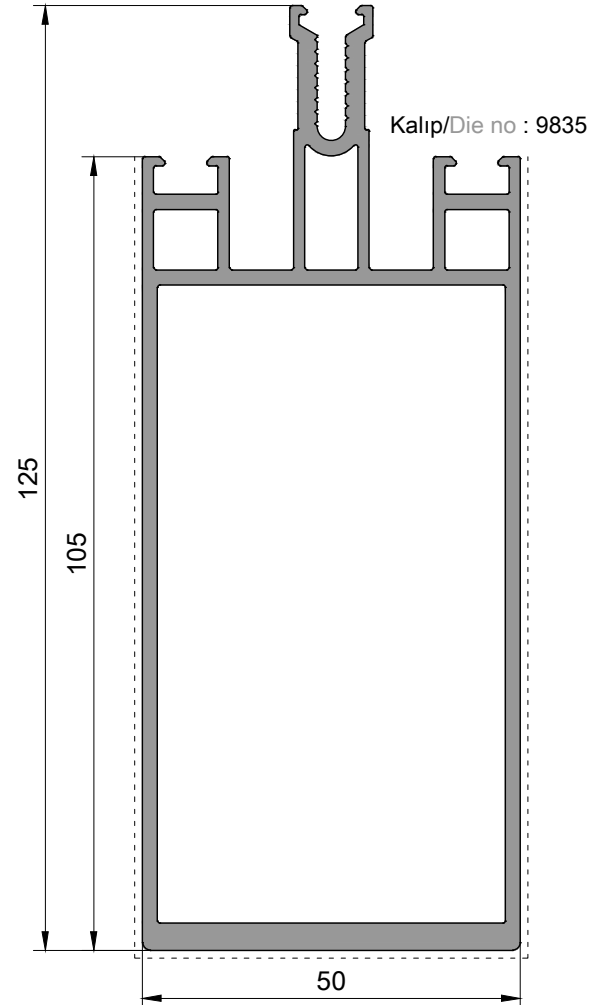

Ix : 152.44 cm⁴
Iy : 30.56 cm⁴
Wx : 23.41 cm³
Wy : 12.22 cm³

P 1386

105mm DÜŞEY PROFİL

105mm mullion profile

Ağırlık/Weight : 2,550 kg/mt

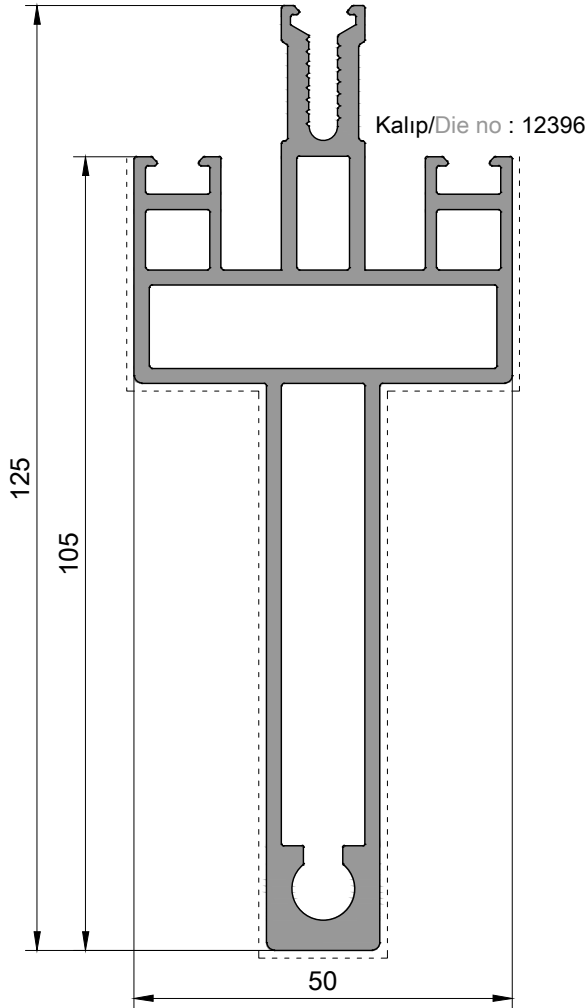

Ix : 124.85 cm⁴
Iy : 13.44 cm⁴
Wx : 18.38 cm³
Wy : 5.37 cm³

P 1387

115mm DÜŞEY PROFİL

115mm mullion profile

Ağırlık/Weight : 2,105 kg/mt

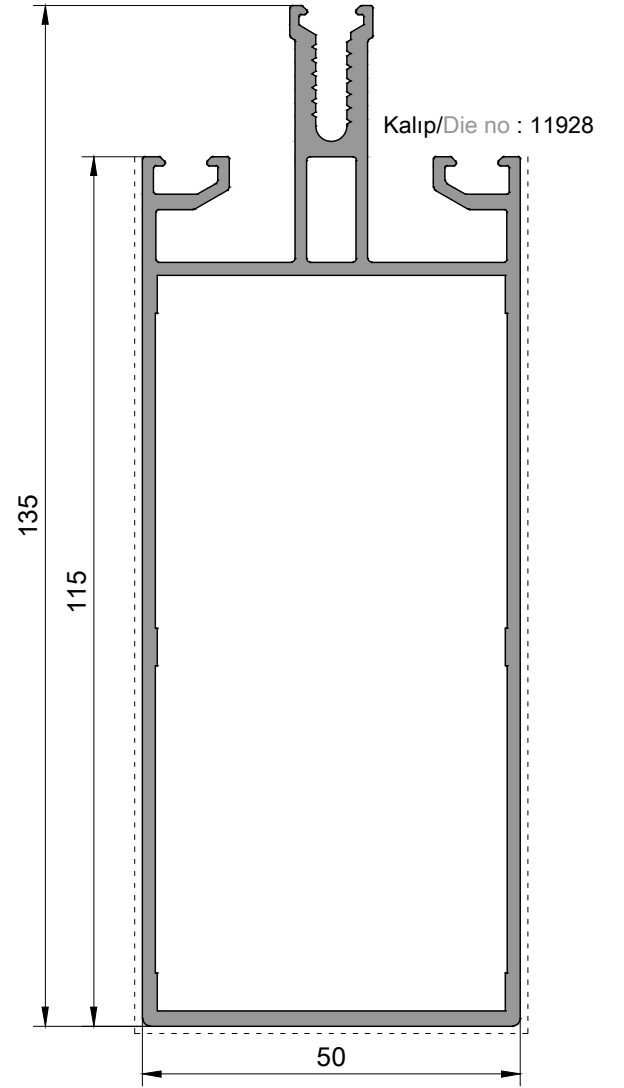

Ix : 149.23 cm⁴
Iy : 28.29 cm⁴
Wx : 21.07 cm³
Wy : 11.31 cm³

P 1388

130mm DÜŞEY PROFİL

130mm mullion profile

Ağırlık/Weight : 3,740 kg/mt

P 1389

130mm DÜŞEY PROFİL

130mm mullion profile

Ağırlık/Weight : 2,920 kg/mt

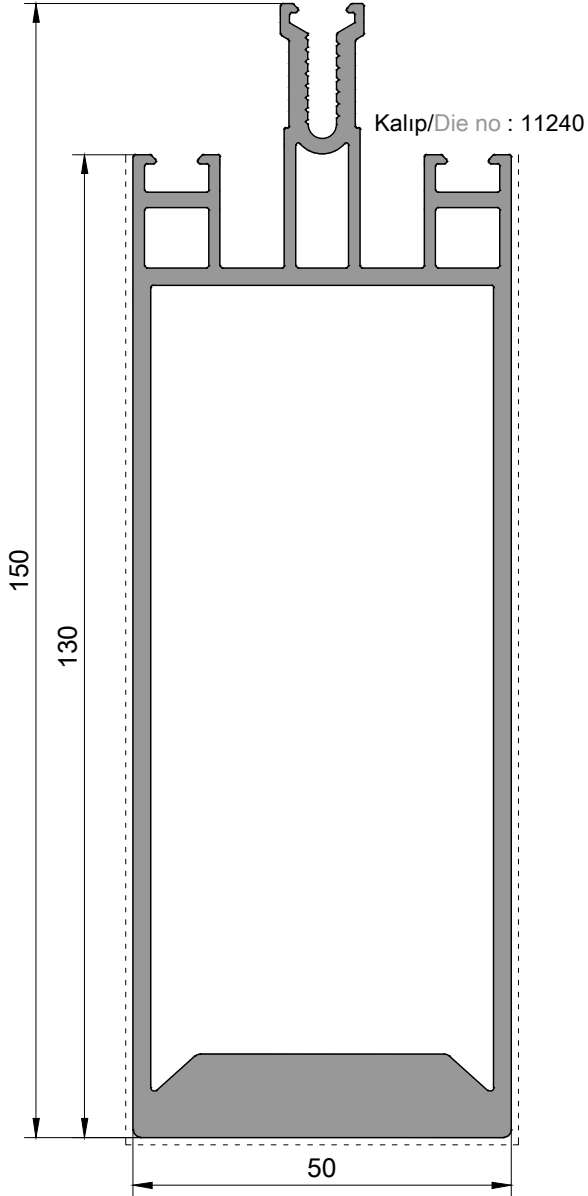

Ix : 364.01 cm⁴
Iy : 44.32 cm⁴
Wx : 39.82 cm³
Wy : 17.73 cm³

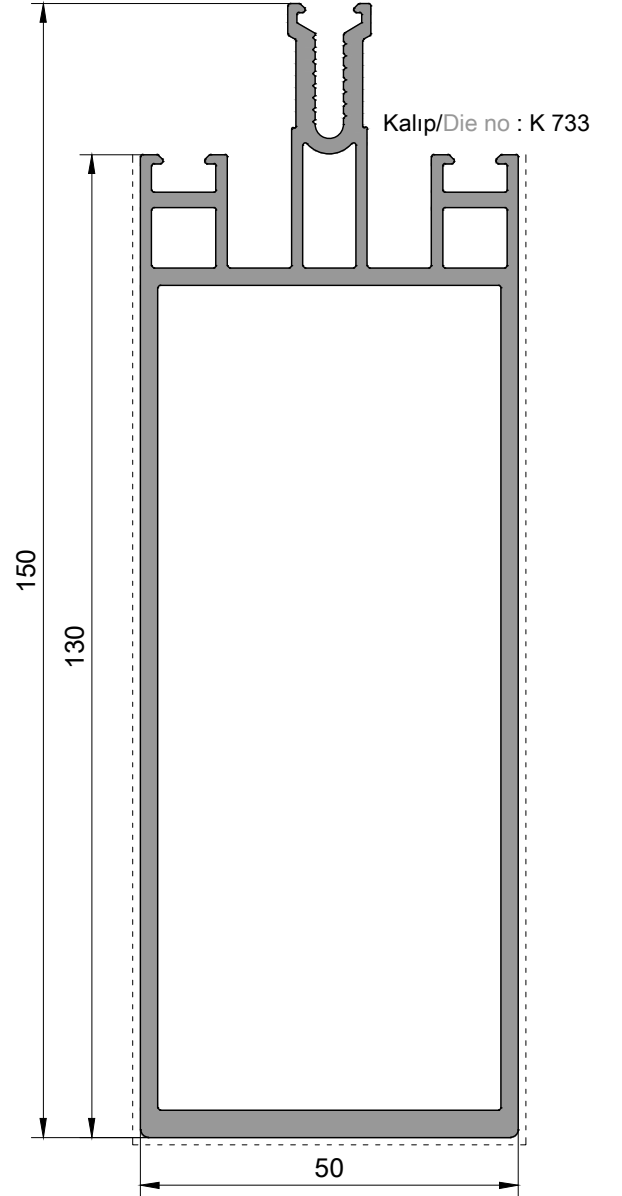

Ix : 260.98 cm⁴
Iy : 39.98 cm⁴
Wx : 33.93 cm³
Wy : 15.99 cm³

P 1390

130mm DIŐI DÜŐEY PROFİL

130mm mullion profile

Ağırlık/Weight : 2,270 kg/mt

P 1391

130mm ERKEK DÜŐEY PROFİL

130mm mullion profile

Ağırlık/Weight : 1,850 kg/mt

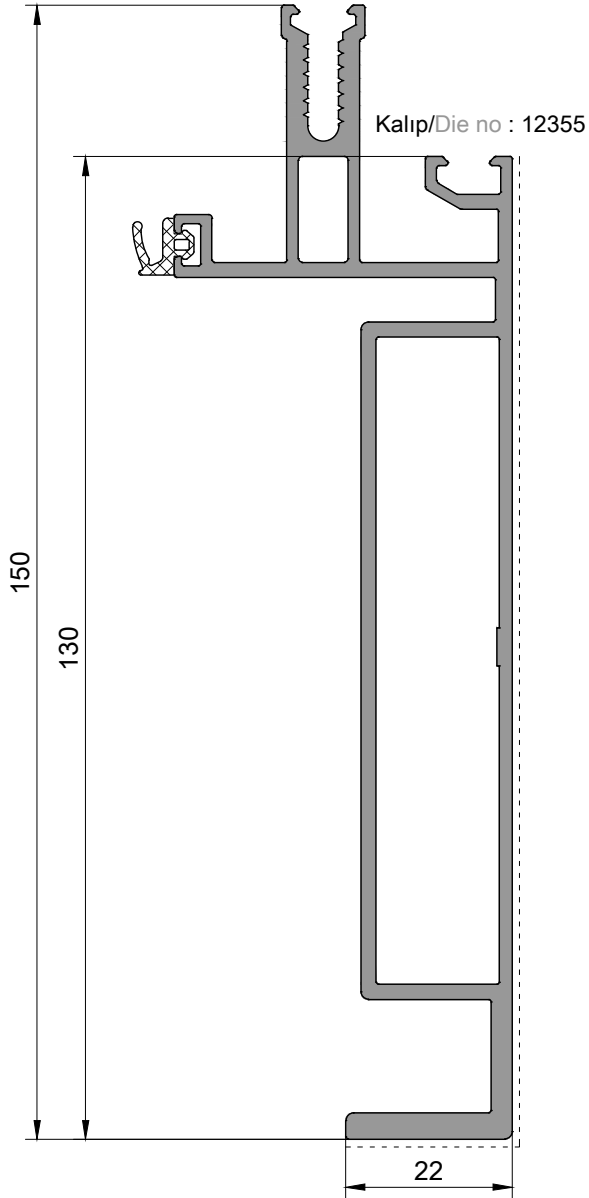

Ix : 185.41 cm⁴
Iy : 8.50 cm⁴
Wx : 23.50 cm³
Wy : 2.76 cm³

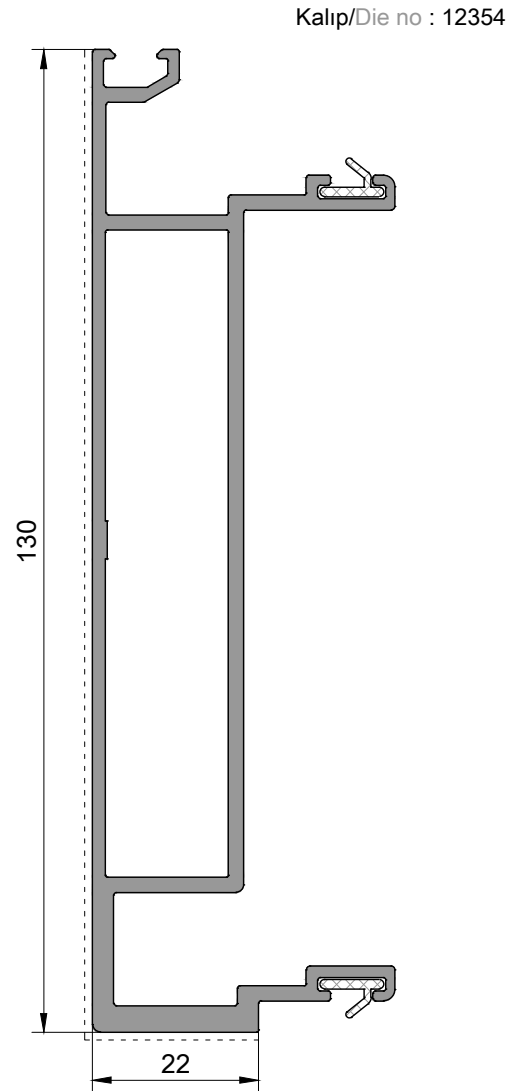

Ix : 122.94 cm⁴
Iy : 7.82 cm⁴
Wx : 17.07 cm³
Wy : 2.81 cm³

P 1392

130mm DÜŞEY PROFİL,
130mm mullion profile

Ağırlık/Weight : 2,500 kg/mt

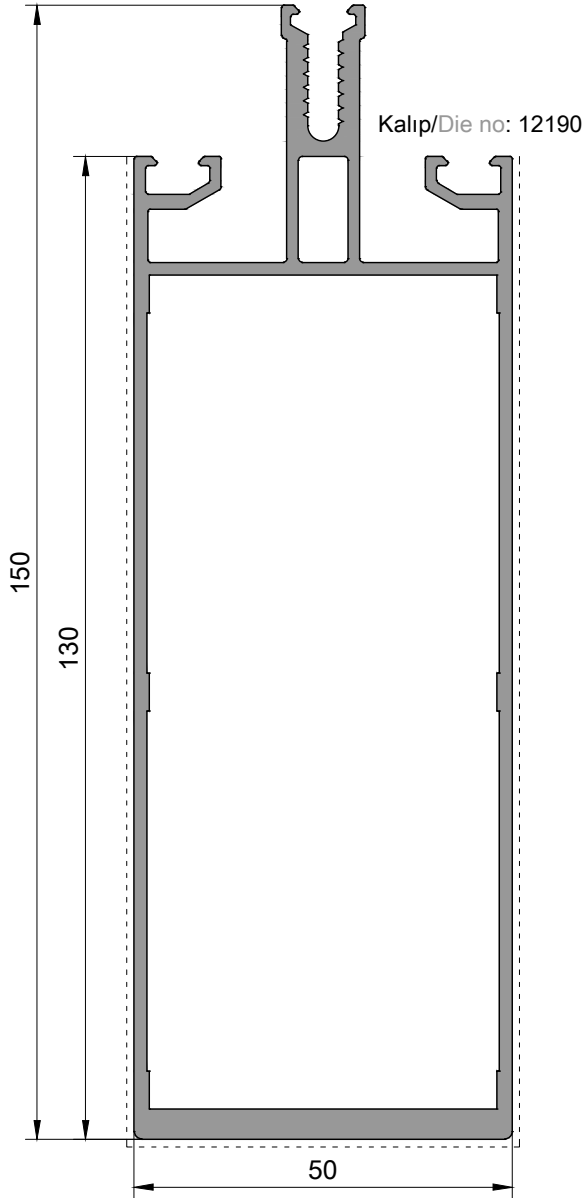

Ix : 247.76 cm⁴
Iy : 32.95 cm⁴
Wx : 31.56 cm³
Wy : 13.18 cm³

P 1393

90° DÜŞEY KÖŞE PROFİL
90° mullion corner profile

Ağırlık/Weight : 3,920 kg/mt

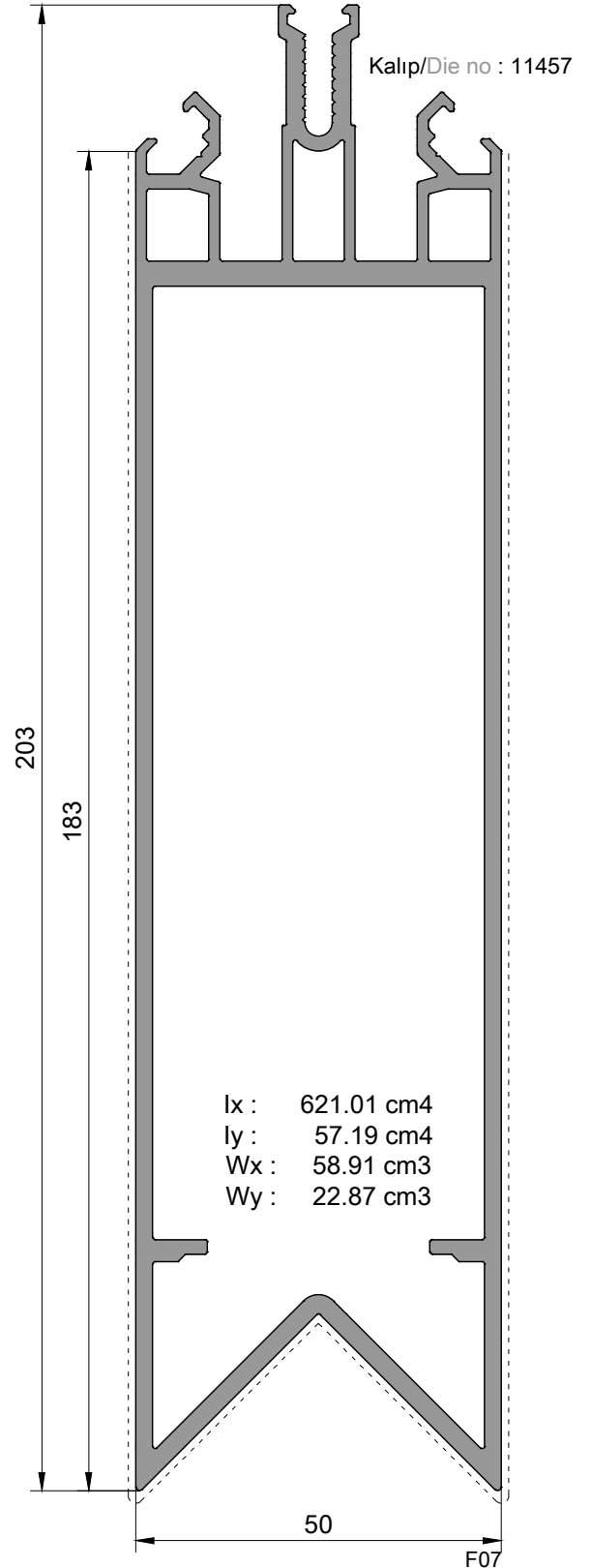

Ix : 621.01 cm⁴
Iy : 57.19 cm⁴
Wx : 58.91 cm³
Wy : 22.87 cm³

P 1394

150mm DÜŞEY PROFİL

150mm mullion profile

Ağırlık/Weight : 3,065 kg/mt

P 1395

155mm DÜŞEY PROFİL

155mm mullion profile

Ağırlık/Weight : 3,660 kg/mt

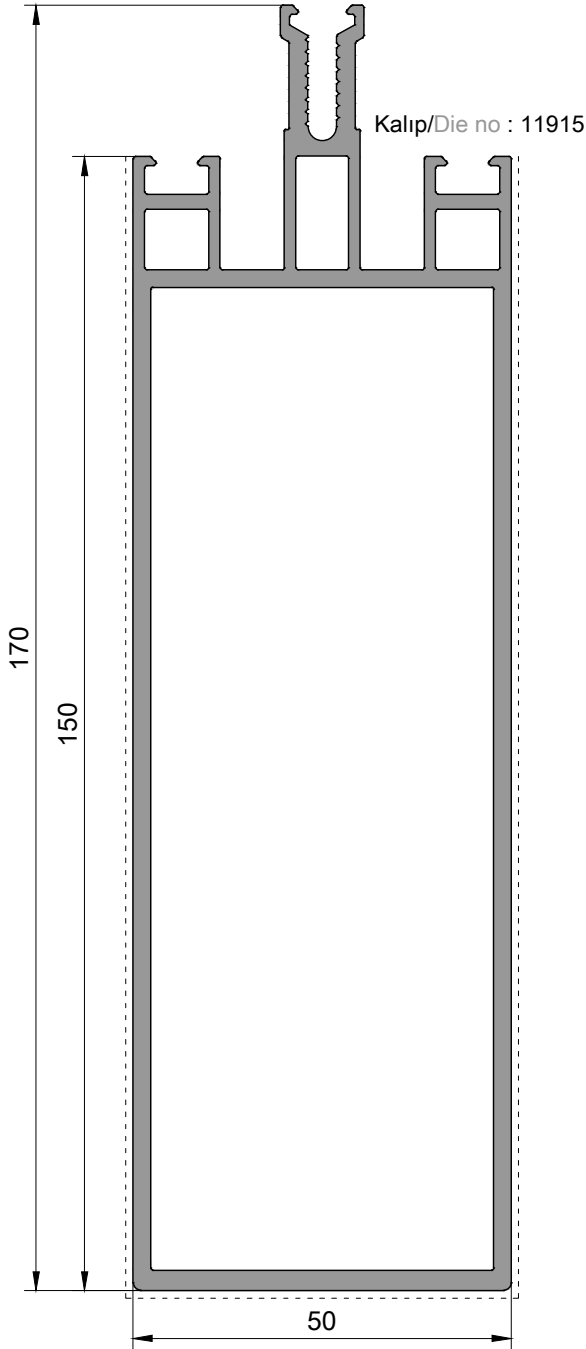

Ix : 341.78 cm⁴
Iy : 44.52 cm⁴
Wx : 39.33 cm³
Wy : 17.80 cm³

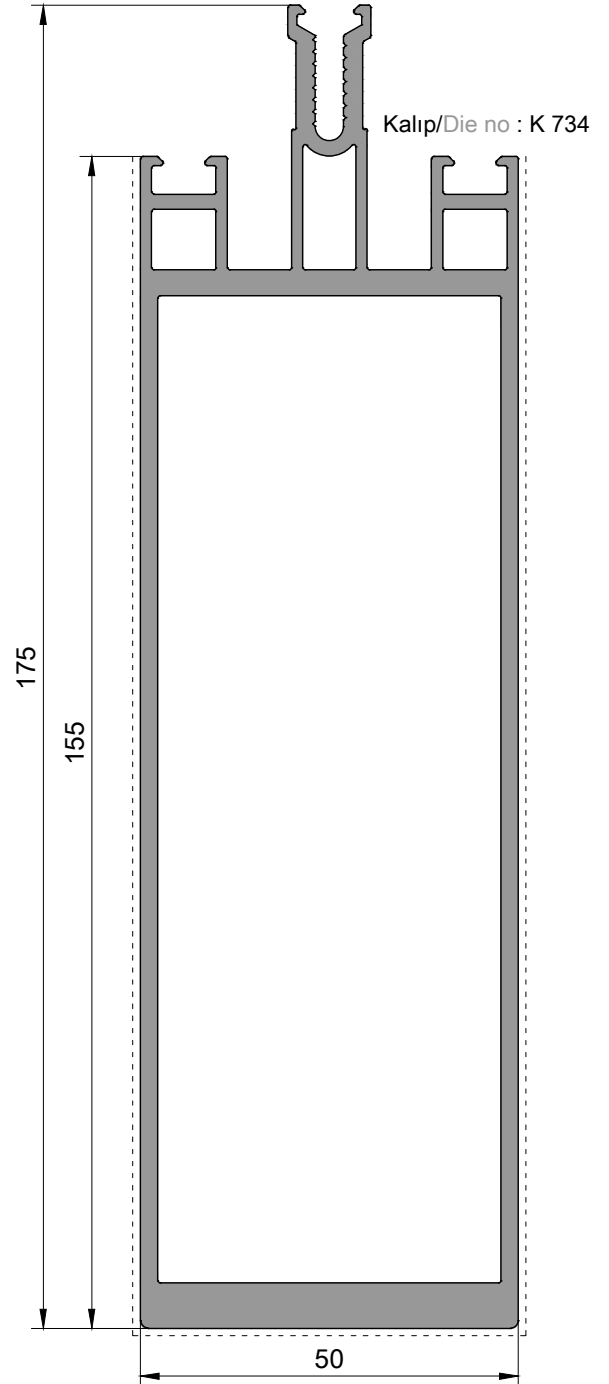

Ix : 480.33 cm⁴
Iy : 49.26 cm⁴
Wx : 51.48 cm³
Wy : 19.70 cm³

P 1858
160mm DÜŞEY PROFİL
160mm mullion profile
Ağırlık/Weight : 3,587kg/mt

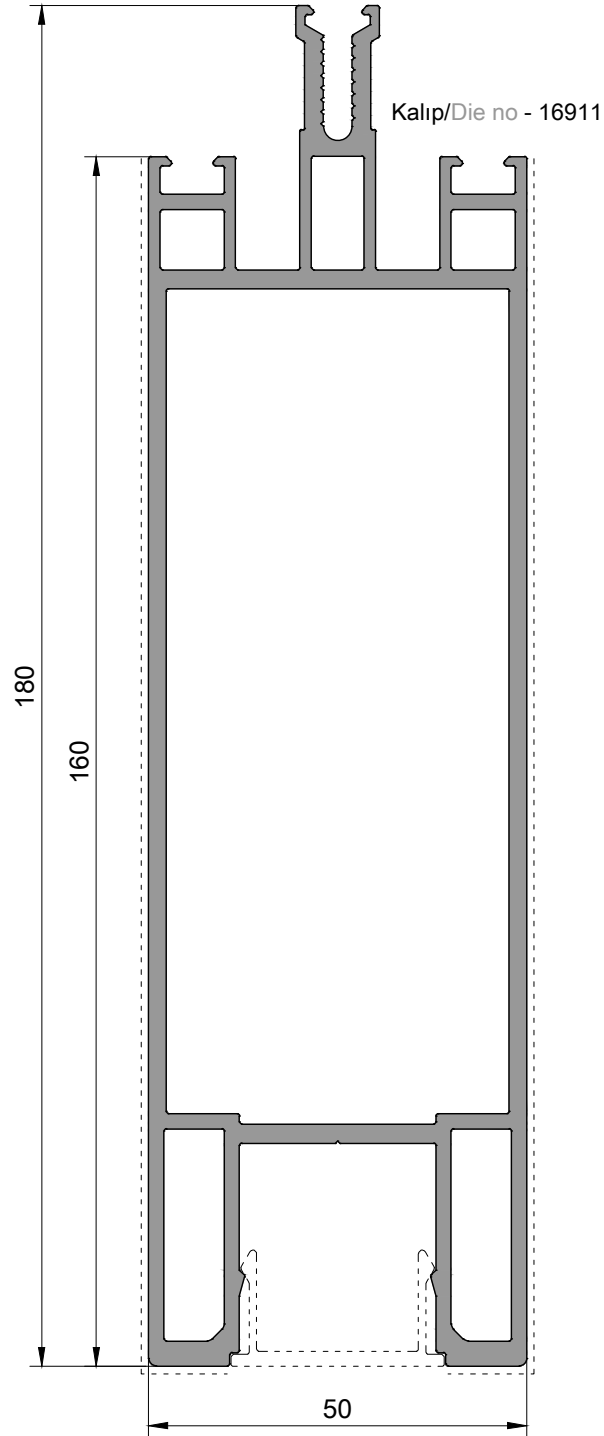

Ix : 442.61 cm⁴
Iy : 50.28 cm⁴
Wx : 47,30 cm³
Wy : 20,11 cm³

P 1396

160mm DÜŞEY PROFİL

160mm mullion profile

Ağırlık/Weight : 2,900 kg/mt

P 1397

160mm DÜŞEY PROFİL

160mm mullion profile

Ağırlık/Weight : 2,610 kg/mt

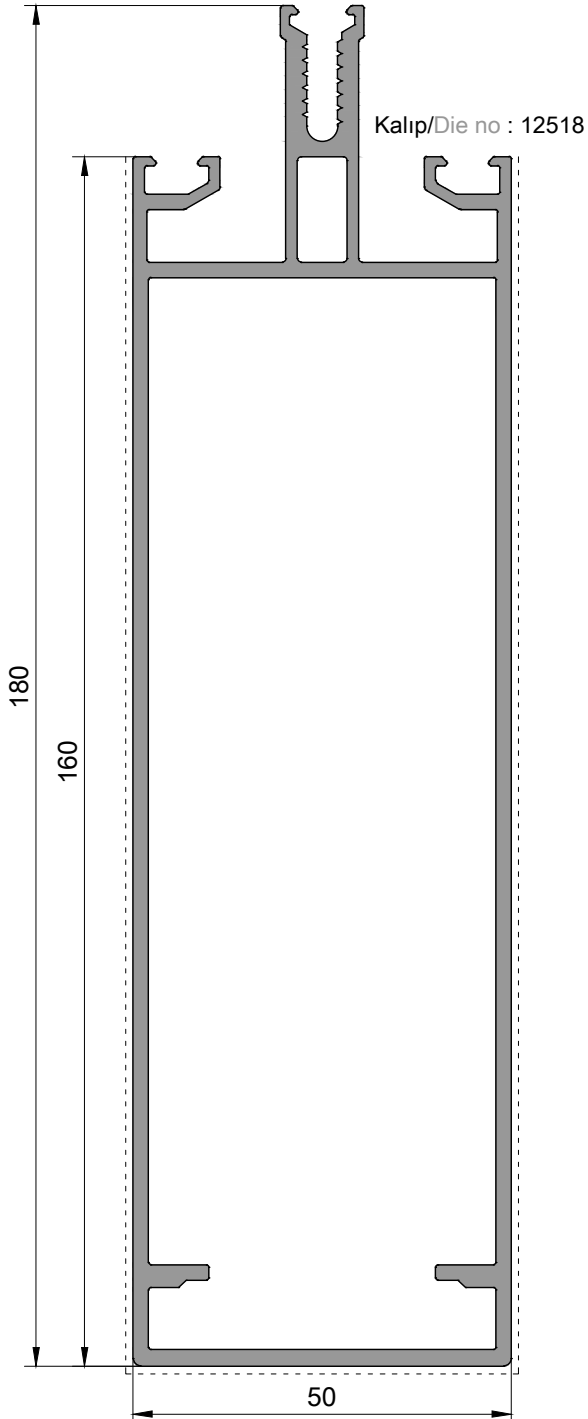

Ix : 380.14 cm⁴
Iy : 43.28 cm⁴
Wx : 41.91 cm³
Wy : 17.31 cm³

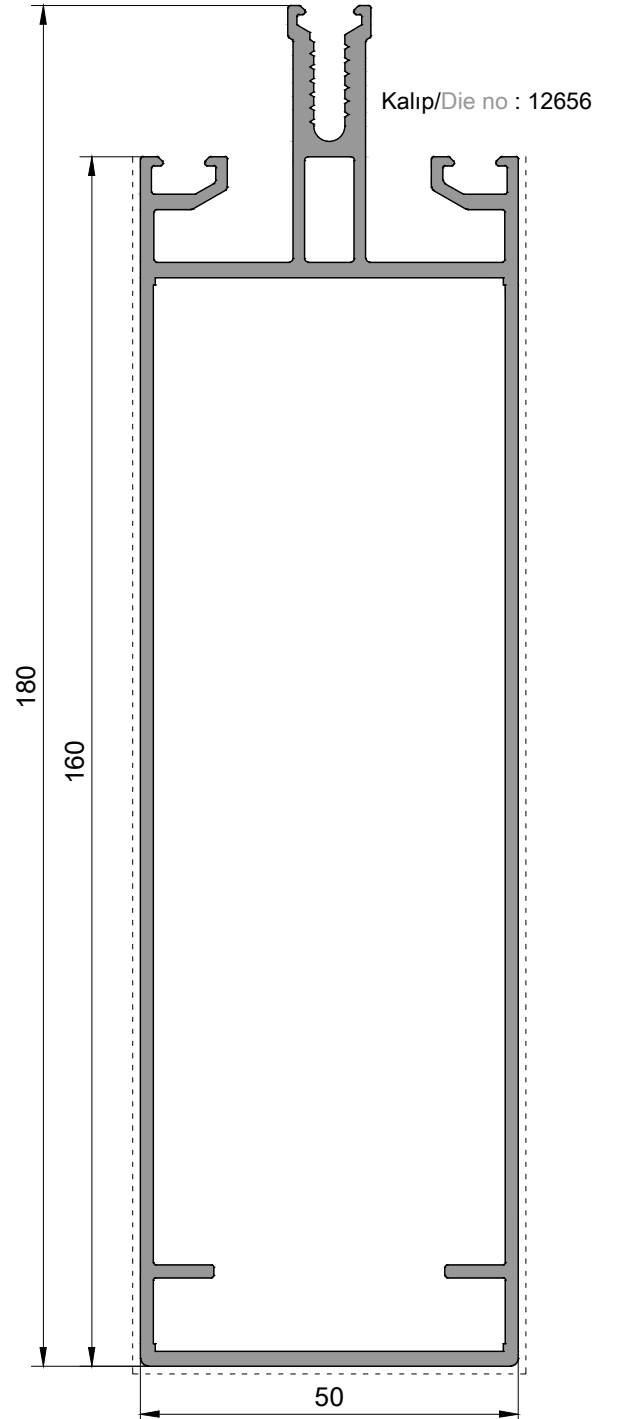

Ix : 346.58 cm⁴
Iy : 38.08 cm⁴
Wx : 36.79 cm³
Wy : 15.23 cm³

P 1860

180mm DÜŞEY PROFİL

180mm mullion profile

Ağırlık/Weight : 4,450 kg/mt

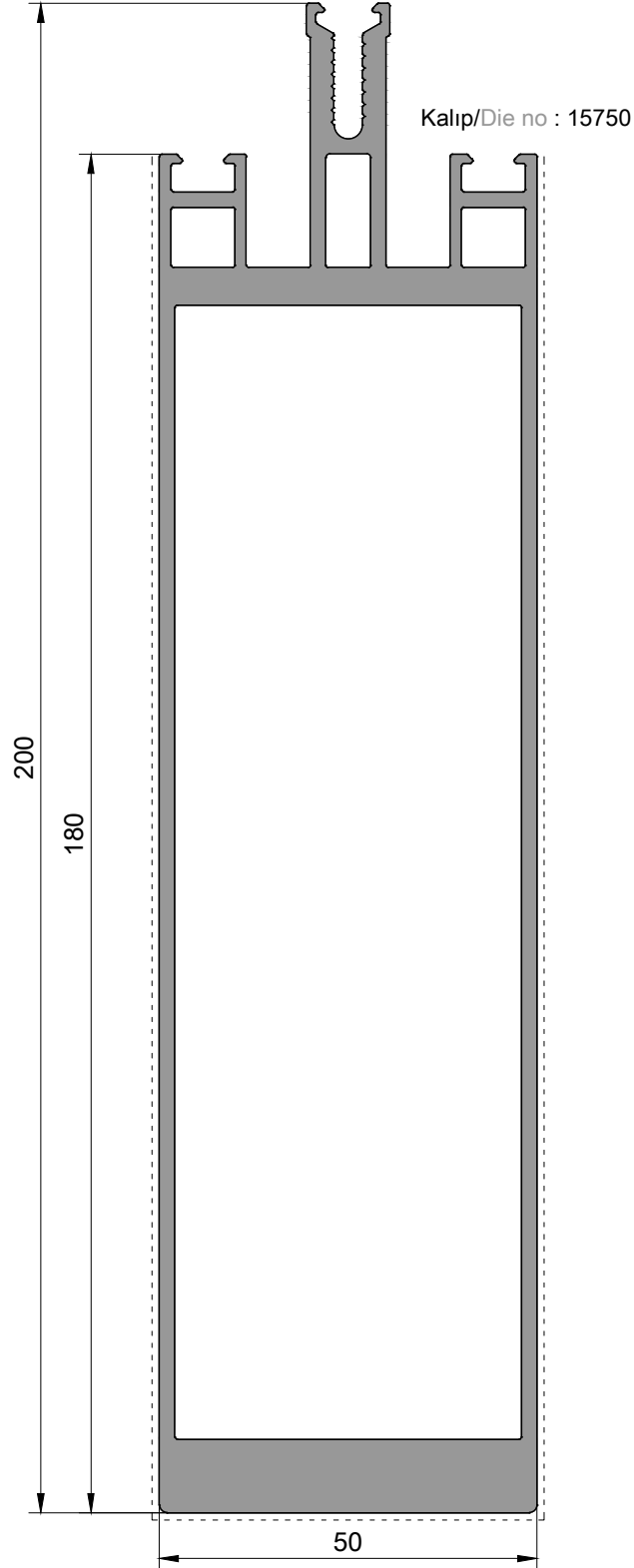

Ix : 848.44 cm⁴
Iy : 55.28 cm⁴
Wx : 77,81 cm³
Wy : 22,11 cm³

P 1398

195mm DÜŞEY PROFİL

195mm mullion profile

Ağırlık/Weight : 3,445 kg/mt

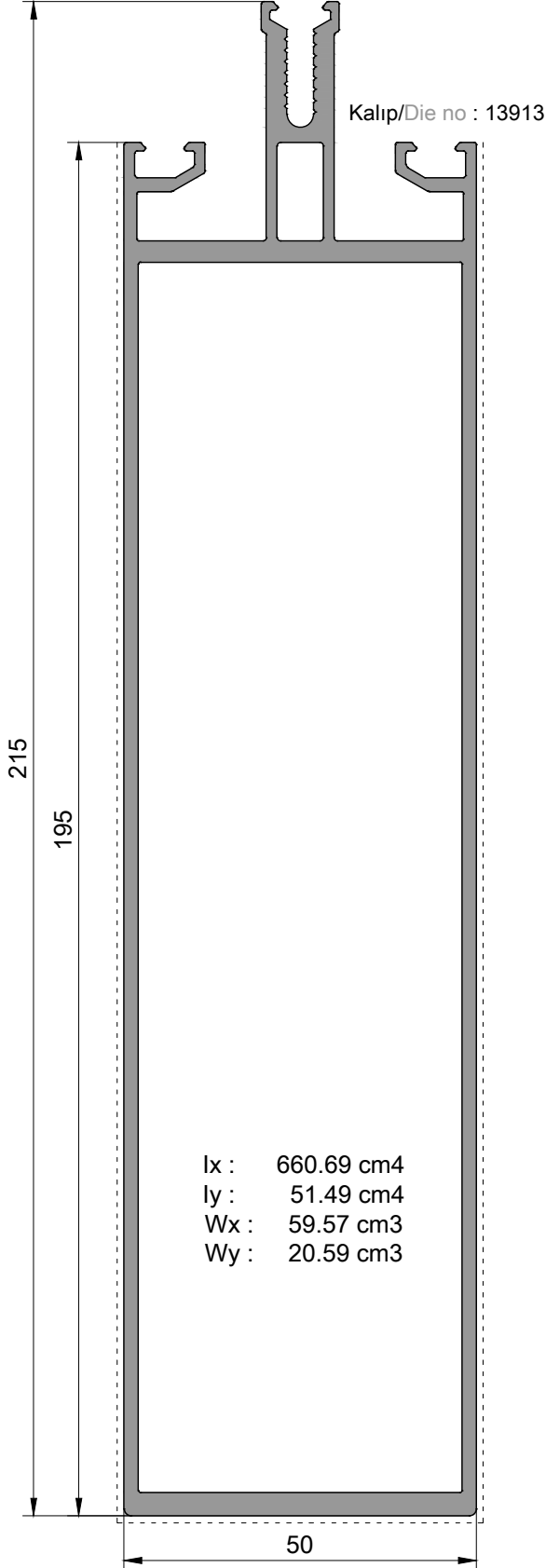

P 1399

205mm DÜŞEY PROFİL

205mm mullion profile

Ağırlık/Weight : 4,760 kg/mt

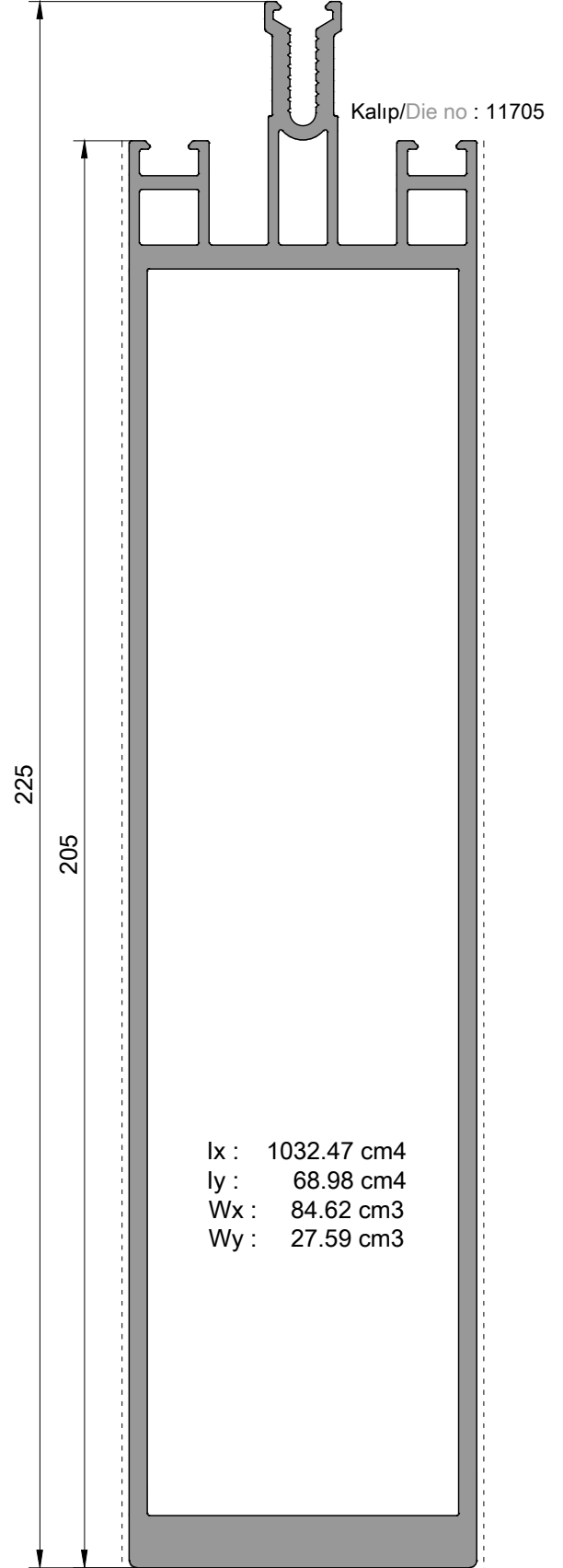

P 1400
240mm DÜŞEY PROFİL
240mm mullion profile
Ağırlık/Weight : 5,110 kg/mt

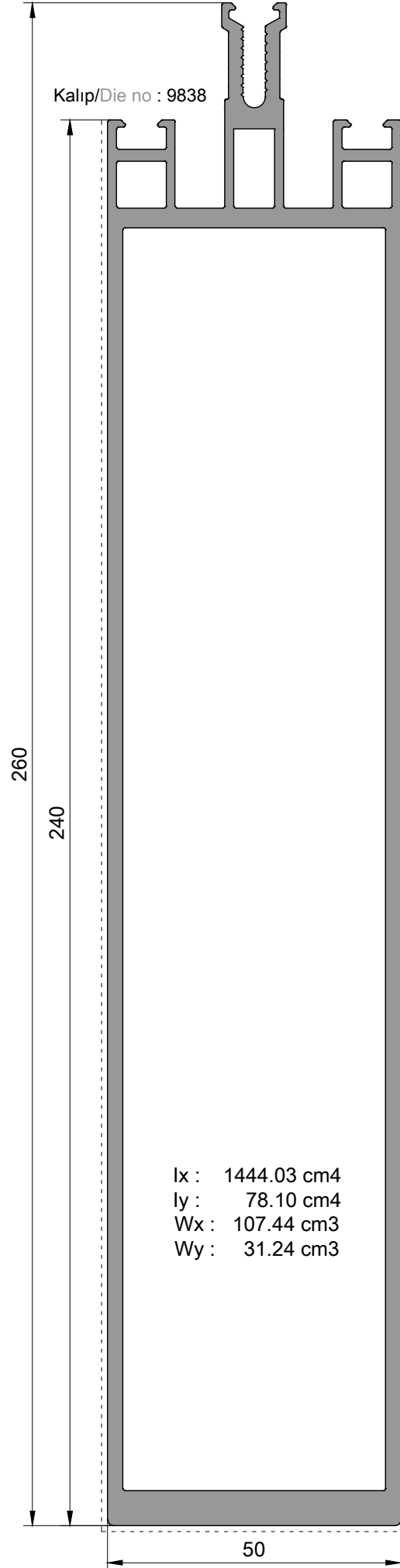

P 1994
250mm DÜŞEY PROFİL
250mm mullion profile
Ağırlık/Weight : 6,110 kg/mt

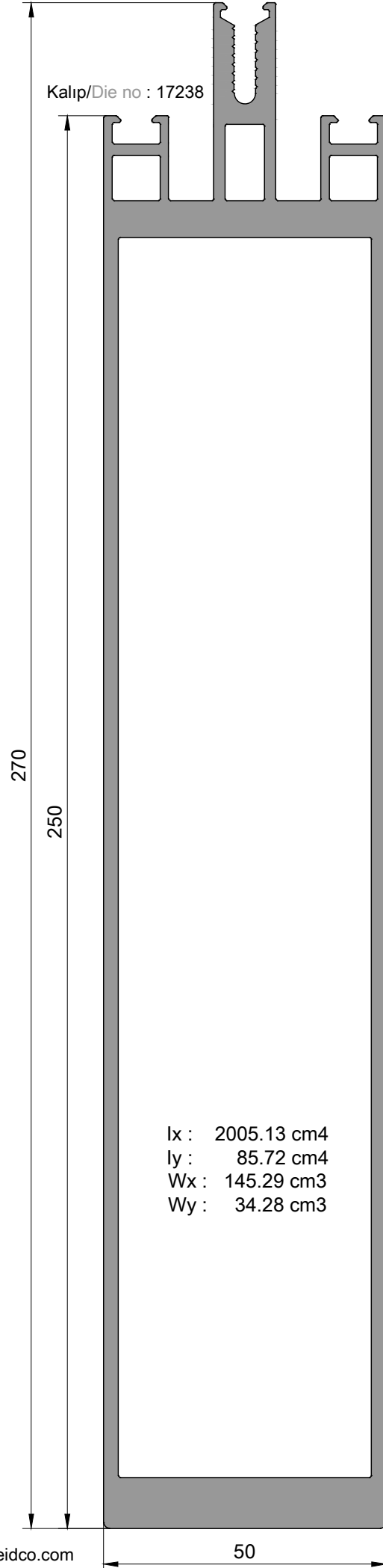

P 1859
265mm DÜŞEY PROFİL
265mm mullion profile
Ağırlık/Weight : 10,320 kg/mt

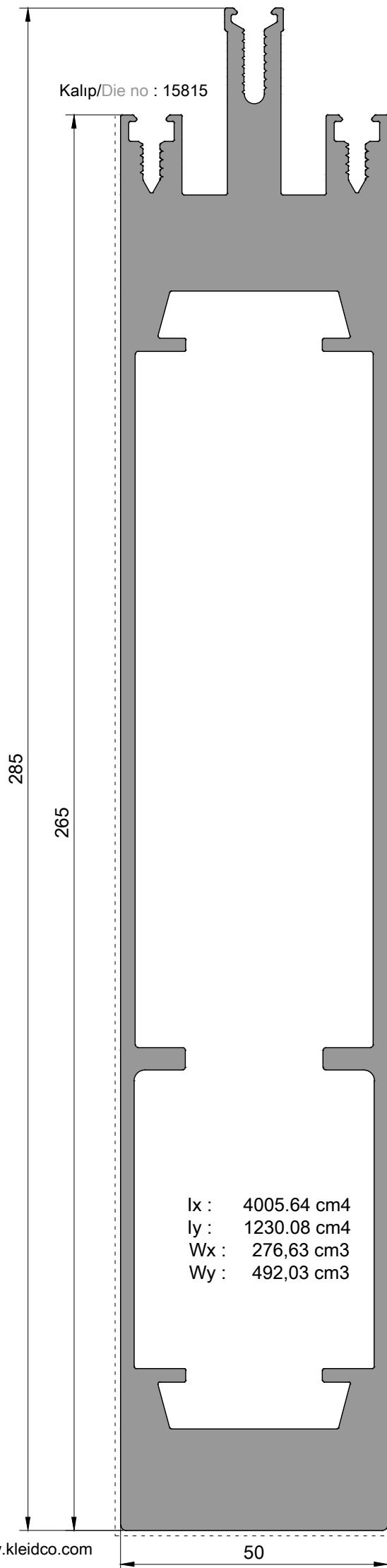

P 1401

6mm YATAY PROFİL

6mm transom profile

Ağırlık/Weight : 0,600 kg/mt

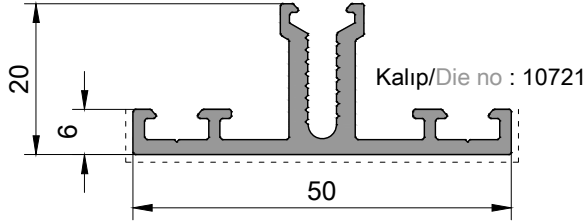

Ix : 8.94 cm⁴
Iy : 4.06 cm⁴
Wx : 4.00 cm³
Wy : 1.62 cm³

P 1402

23mm YATAY PROFİL

23mm transom profile

Ağırlık/Weight : 1,030 kg/mt

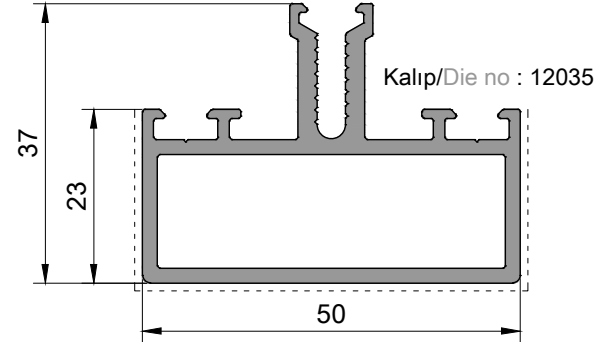

Ix : 8.94 cm⁴
Iy : 4.06 cm⁴
Wx : 4.00 cm³
Wy : 1.62 cm³

P 1403

60mm YATAY PROFİL

60mm transom profile

Ağırlık/Weight : 1,350 kg/mt

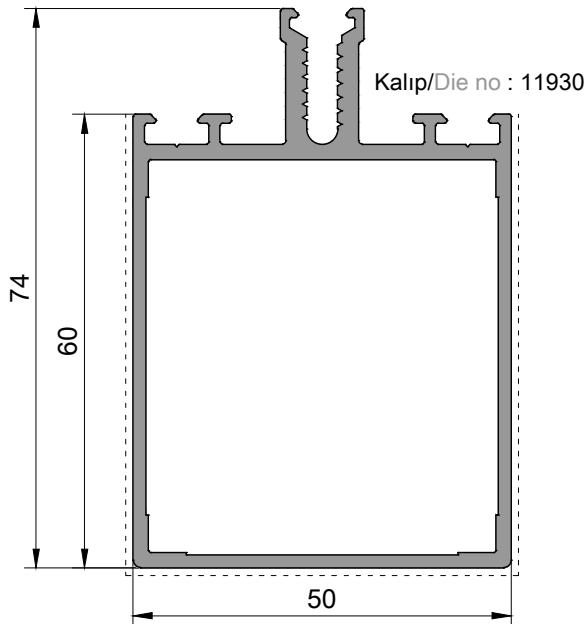

Ix : 29.25 cm⁴
Iy : 16.03 cm⁴
Wx : 7.82 cm³
Wy : 6.41 cm³

P 1404

60mm YATAY PROFİL

60mm transom profile

Ağırlık/Weight : 1,410 kg/mt

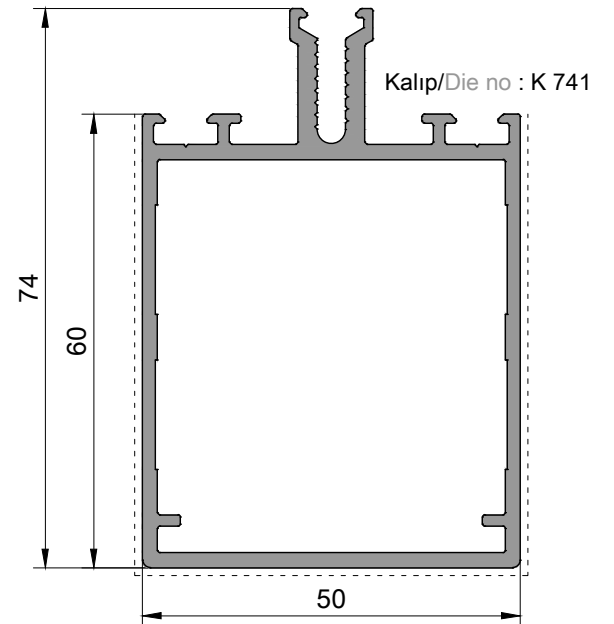

Ix : 31.32 cm⁴
Iy : 16.96 cm⁴
Wx : 8.15 cm³
Wy : 6.78 cm³

P 1857

60mm YATAY PROFİL

60mm transom profile

Ağırlık/Weight : 1,451 kg/mt

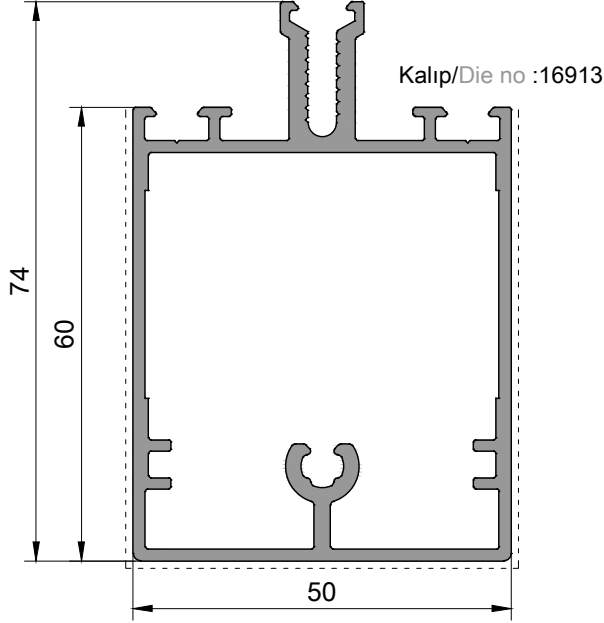

lx : 31.75 cm⁴
ly : 16.18 cm⁴
Wx : 7,87 cm³
Wy : 6,47 cm³

P 1405

85mm YATAY PROFİL

85mm transom profile

Ağırlık/Weight : 1,640 kg/mt

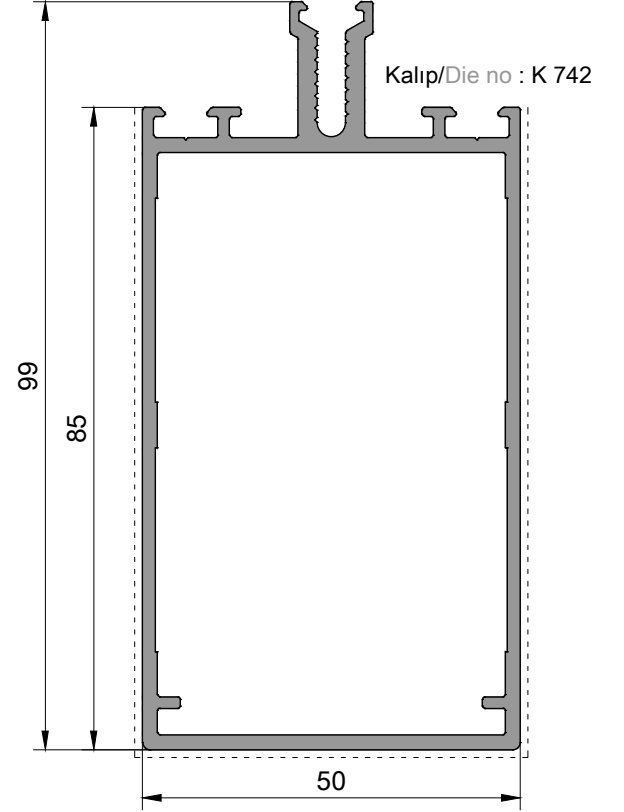

lx : 68.90 cm⁴
ly : 21.92 cm⁴
Wx : 13.86 cm³
Wy : 8.76 cm³

P 1406

95mm YATAY PROFİL

95mm transom profile

Ağırlık/Weight : 1,735 kg/mt

P 1944

85mm YATAY PROFİL

85mm transom profile

Ağırlık/Weight : 1,674 kg/mt

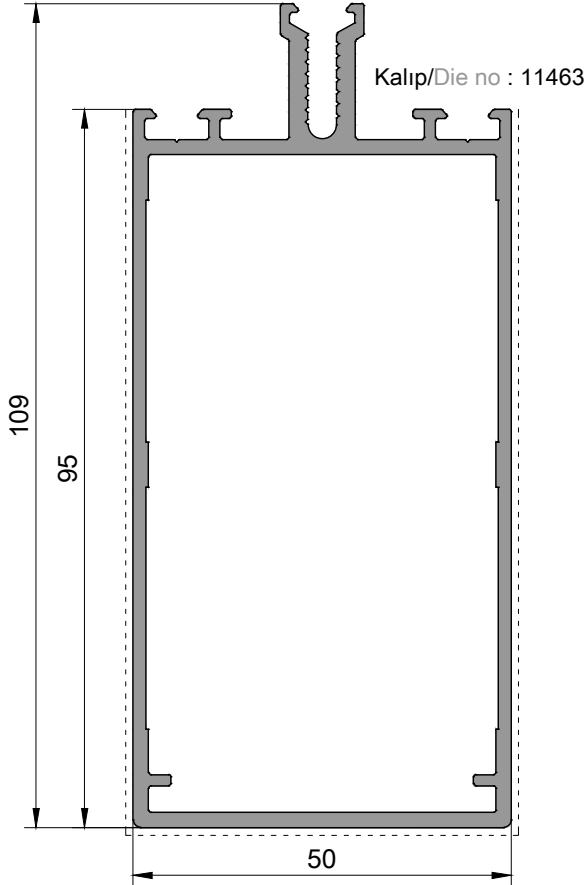

Ix : 89.00 cm⁴
Iy : 23.90 cm⁴
Wx : 16.27 cm³
Wy : 9.56 cm³

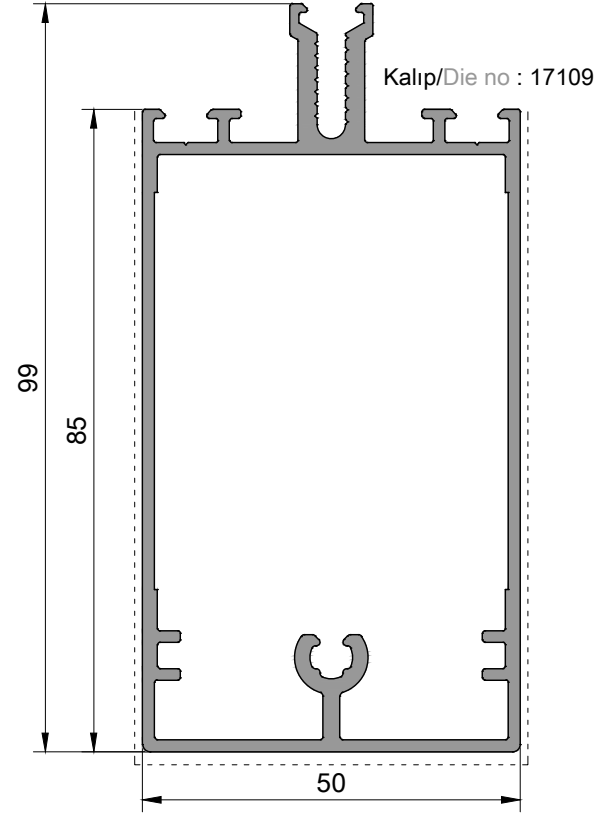

Ix : 70.88 cm⁴
Iy : 20.86 cm⁴
Wx : 13.47 cm³
Wy : 8.34 cm³

P 1409

110mm YATAY PROFİL

110mm transom profile

Ağırlık/Weight : 2,210 kg/mt

P 1407

105mm YATAY PROFİL

105mm transom profile

Ağırlık/Weight : 1,660 kg/mt

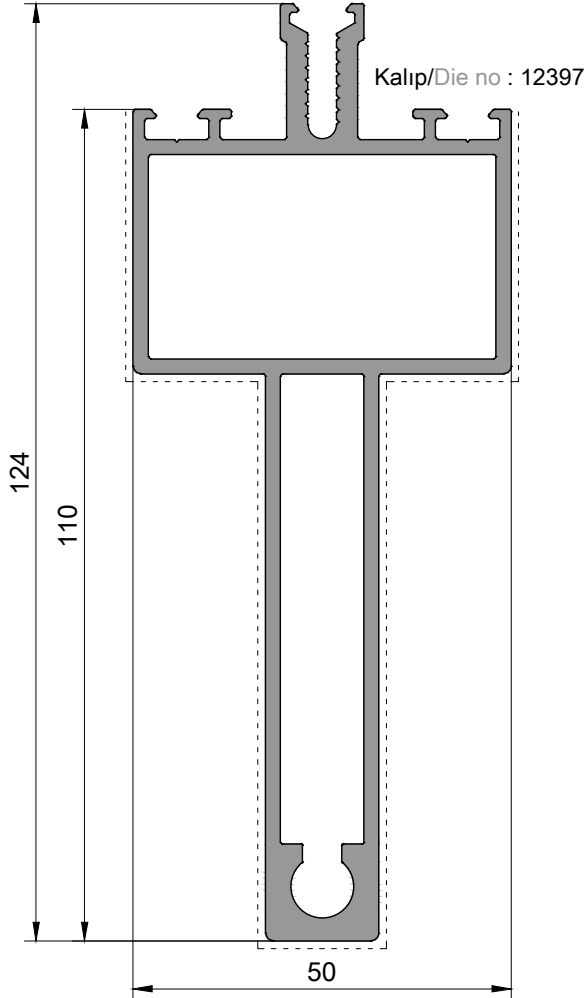

Ix : 119.09 cm⁴
Iy : 13.12 cm⁴
Wx : 17.93 cm³
Wy : 5.24 cm³

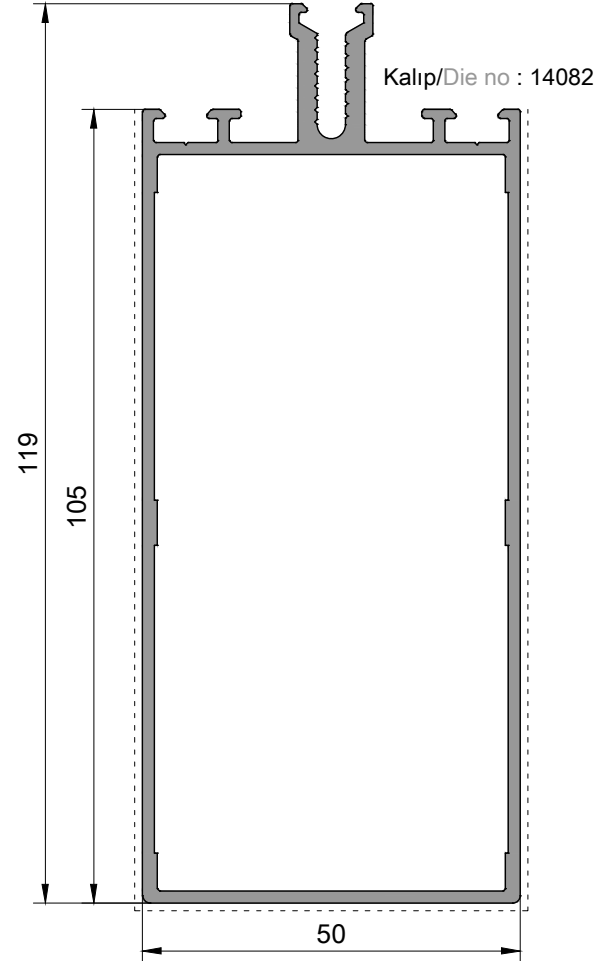

Ix : 98.52 cm⁴
Iy : 23.70 cm⁴
Wx : 15.84 cm³
Wy : 9.48 cm³

P 1856

110mm YATAY PROFİL

110mm transom profile

Ağırlık/Weight : 1,897kg/mt

P 1408

110mm YATAY PROFİL

110mm transom profile

Ağırlık/Weight : 1,915 kg/mt

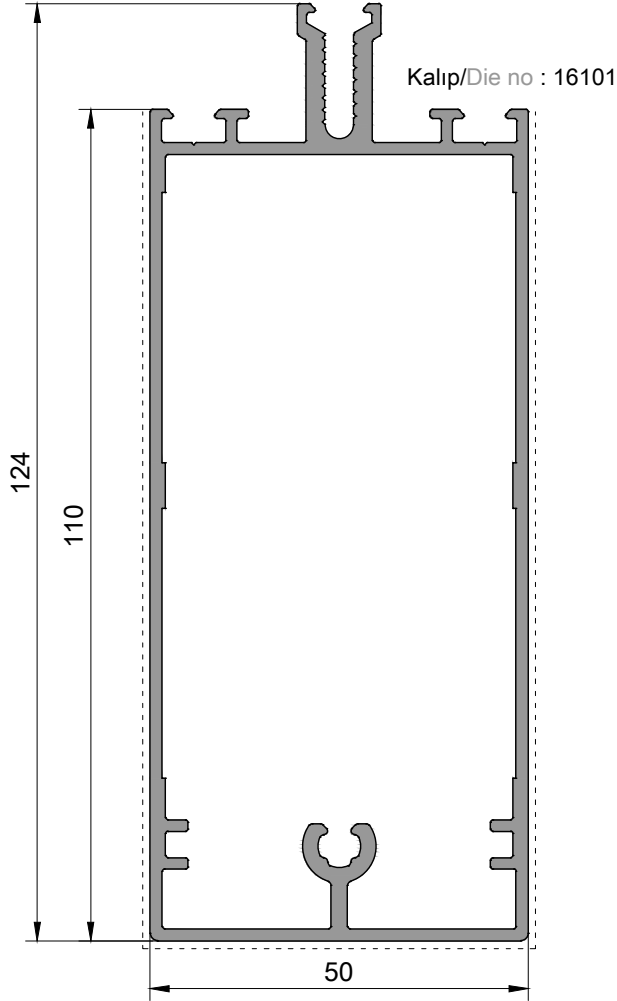

Ix : 129.32 cm⁴
Iy : 25.81 cm⁴
Wx : 19.95 cm³
Wy : 10.32 cm³

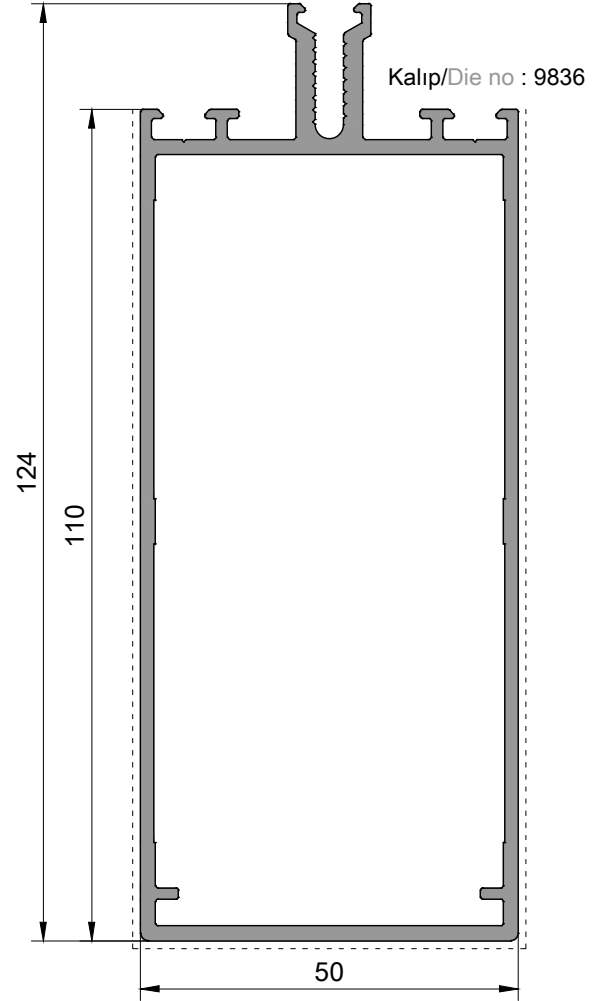

Ix : 126.24 cm⁴
Iy : 27.73 cm⁴
Wx : 20.19 cm³
Wy : 11.09 cm³

P 1410

120mm YATAY PROFİL

120mm transom profile

Ağırlık/Weight : 1,940 kg/mt

P 1855

135mm YATAY PROFİL

135mm transom profile

Ağırlık/Weight : 2,113kg/mt

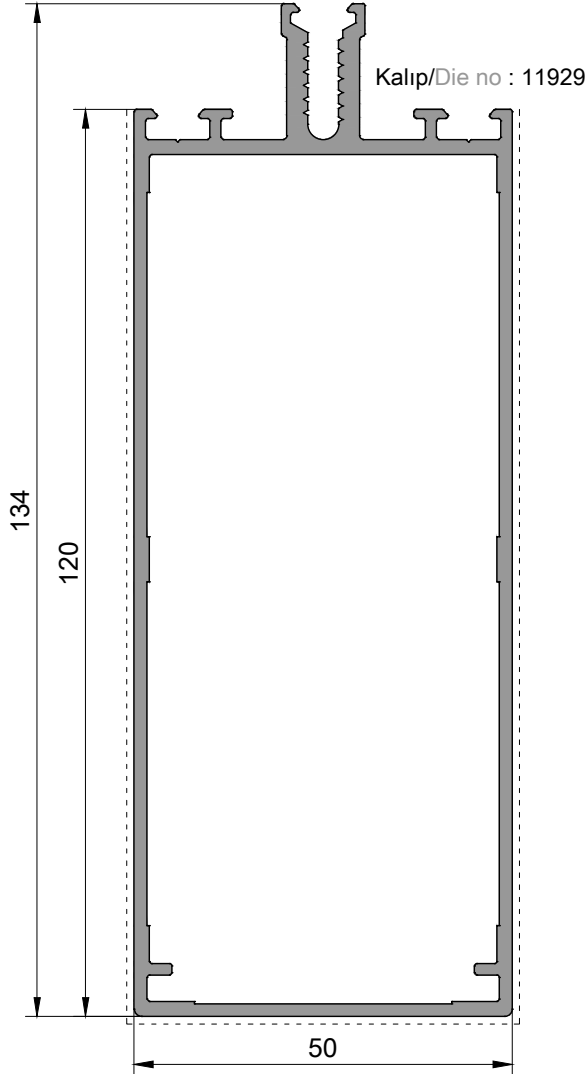

Ix : 149.16 cm⁴
Iy : 28.61 cm⁴
Wx : 21.46 cm³
Wy : 11.44 cm³

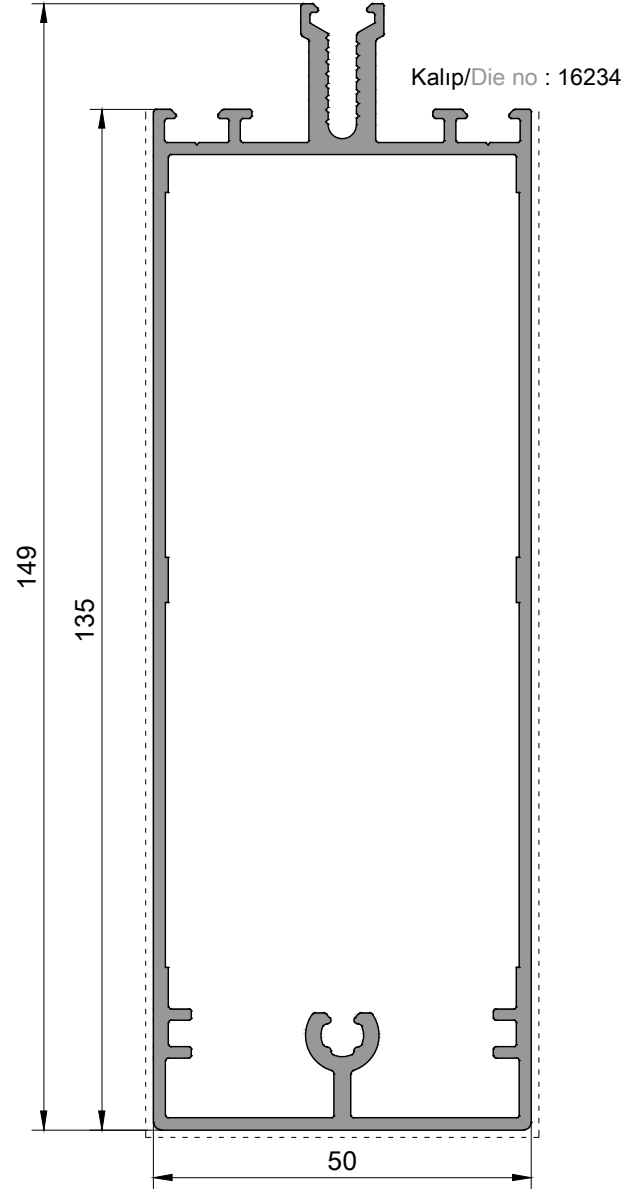

Ix : 209.55 cm⁴
Iy : 30.50 cm⁴
Wx : 27,15 cm³
Wy : 12,20 cm³

P 1411

135mm YATAY PROFİL

135mm transom profile

Ağırlık/Weight : 2,160 kg/mt

P 1412

155mm YATAY PROFİL

155mm transom profile

Ağırlık/Weight : 2,485 kg/mt

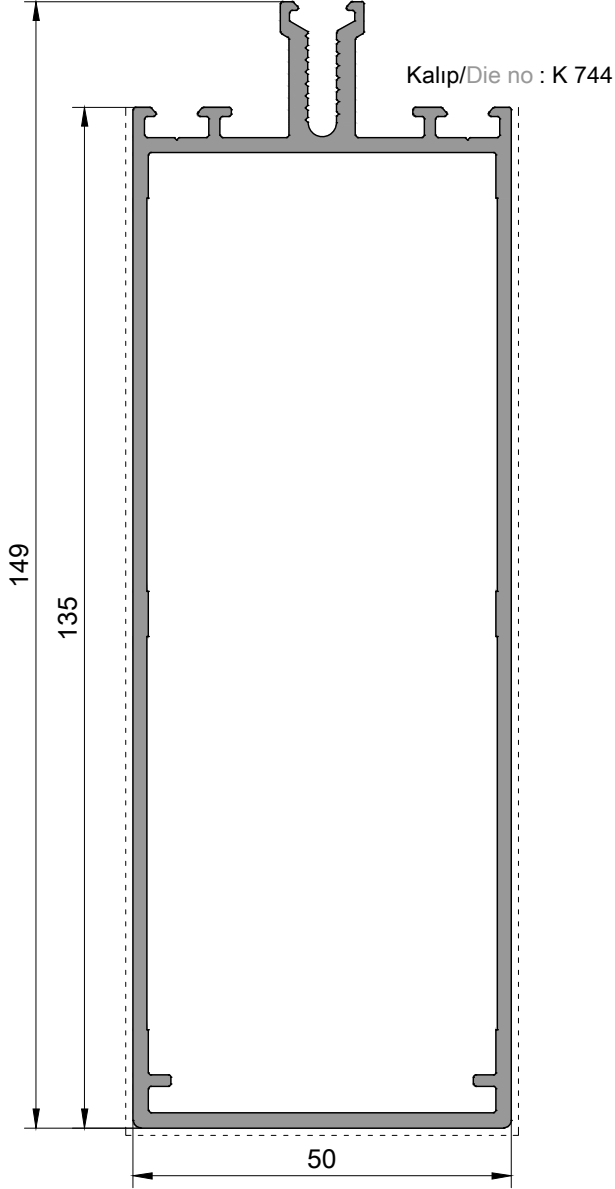

Ix : 205.08 cm⁴
Iy : 32.96 cm⁴
Wx : 27.09 cm³
Wy : 13.18 cm³

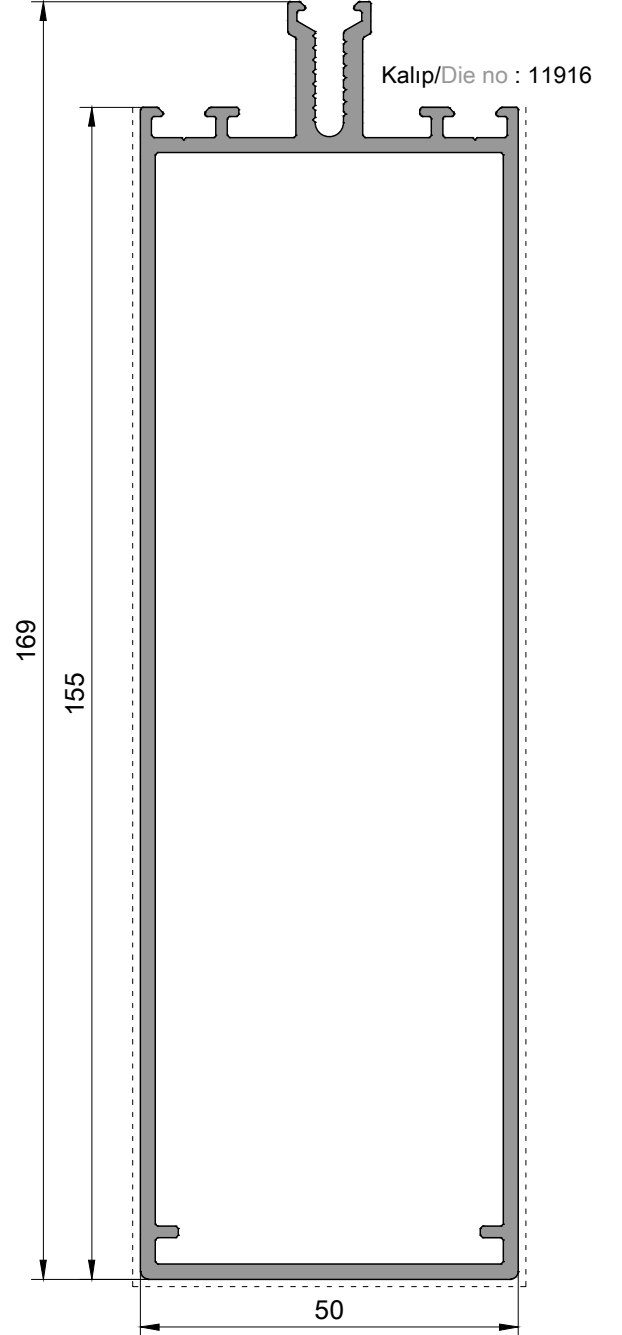

Ix : 293.45 cm⁴
Iy : 39.79 cm⁴
Wx : 34.24 cm³
Wy : 15.91 cm³

P 1413

160mm YATAY PROFİL

160mm transom profile

Ağırlık/Weight : 2,540 kg/mt

P 1414

165mm YATAY PROFİL

165mm transom profile

Ağırlık/Weight : 2,400 kg/mt

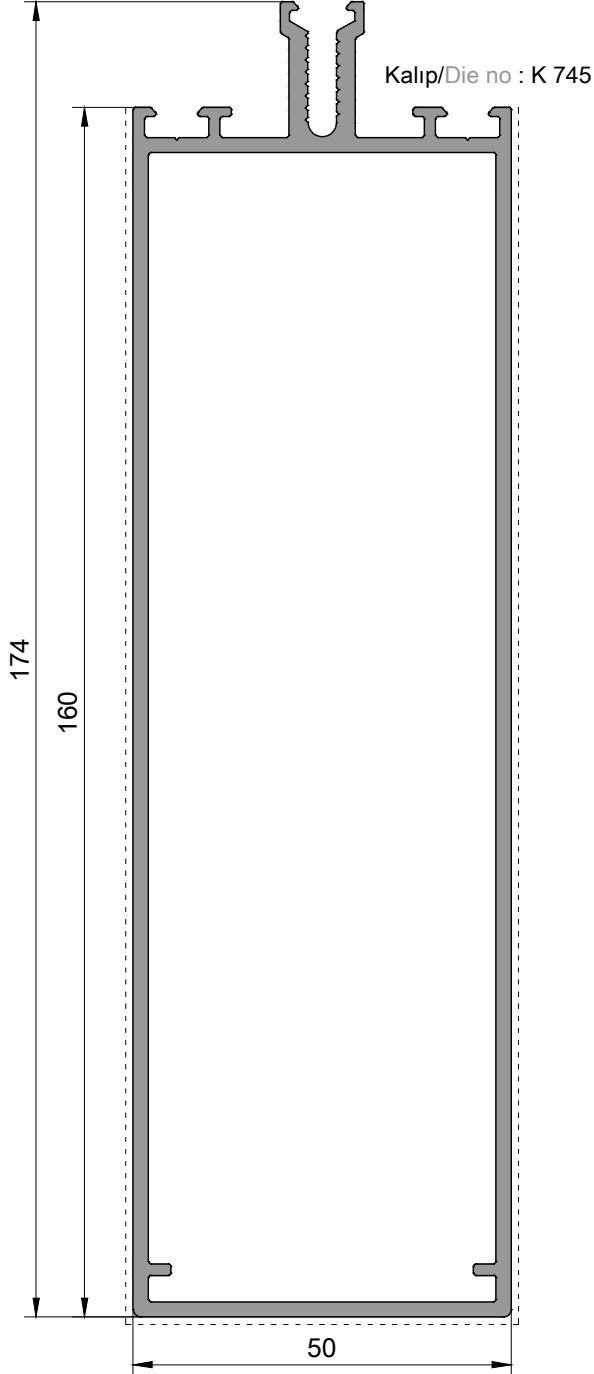

Ix : 317.18 cm⁴
Iy : 40.95 cm⁴
Wx : 35.92 cm³
Wy : 16.38 cm³

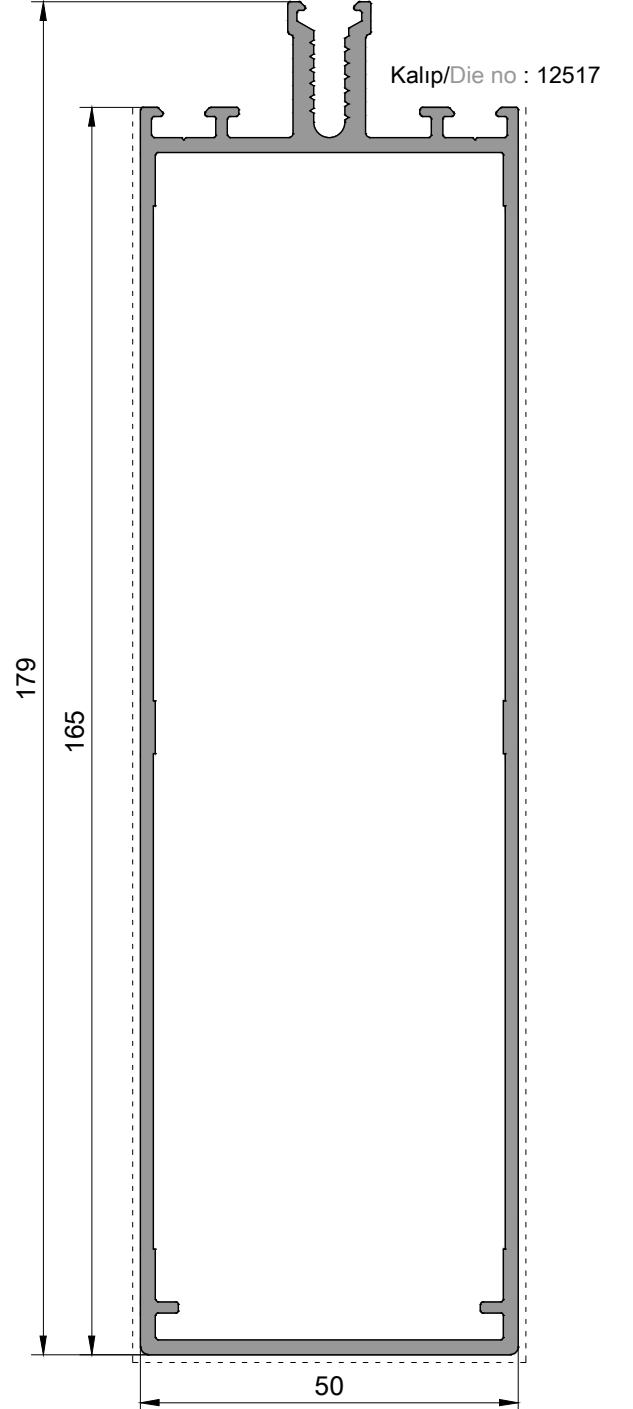

Ix : 331.30 cm⁴
Iy : 37.91 cm⁴
Wx : 36.01 cm³
Wy : 15.16 cm³

P 1854

165mm YATAY PROFİL

165mm transom profile

Ağırlık/Weight : 3,020 kg/mt

P 1853

165mm YATAY PROFİL

165mm transom profile

Ağırlık/Weight : 2,553 kg/mt

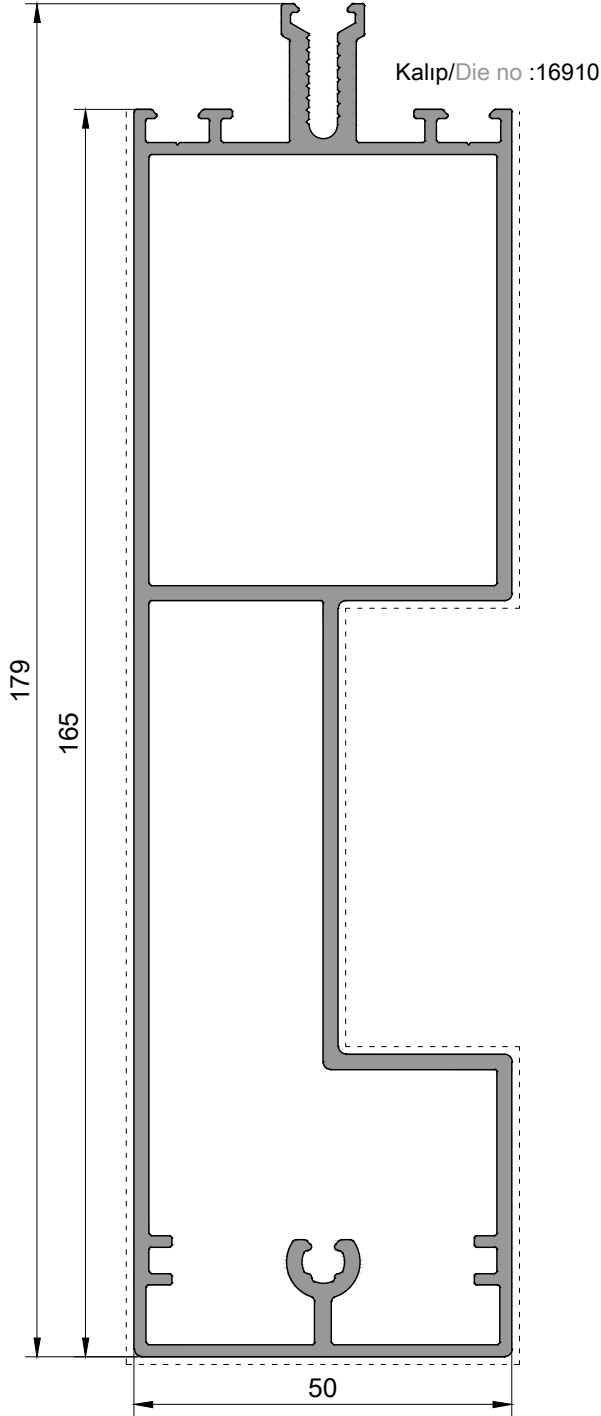

Ix : 365.93 cm⁴
Iy : 36.62 cm⁴
Wx : 39.77 cm³
Wy : 13.56 cm³

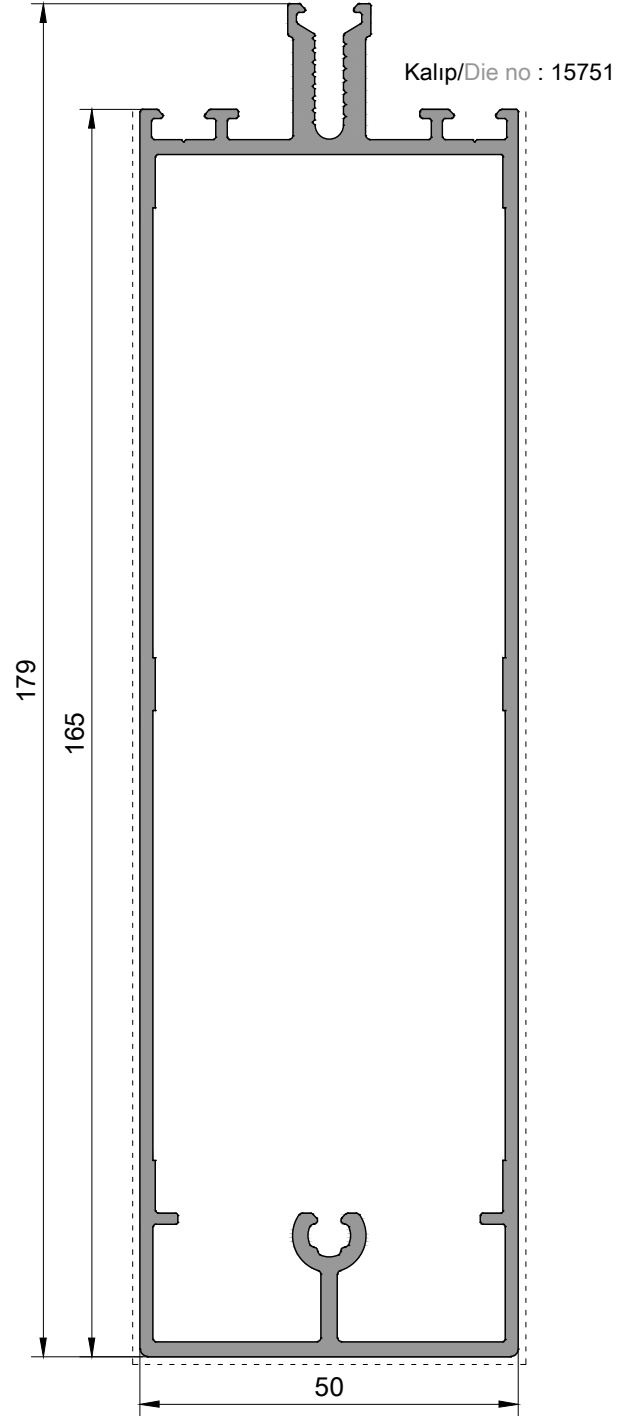

Ix : 366.09 cm⁴
Iy : 37.83 cm⁴
Wx : 40,13 cm³
Wy : 15,13 cm³

P 1993

185mm YATAY PROFİL

185mm transom profile

Ağırlık/Weight : 2,965 kg/mt

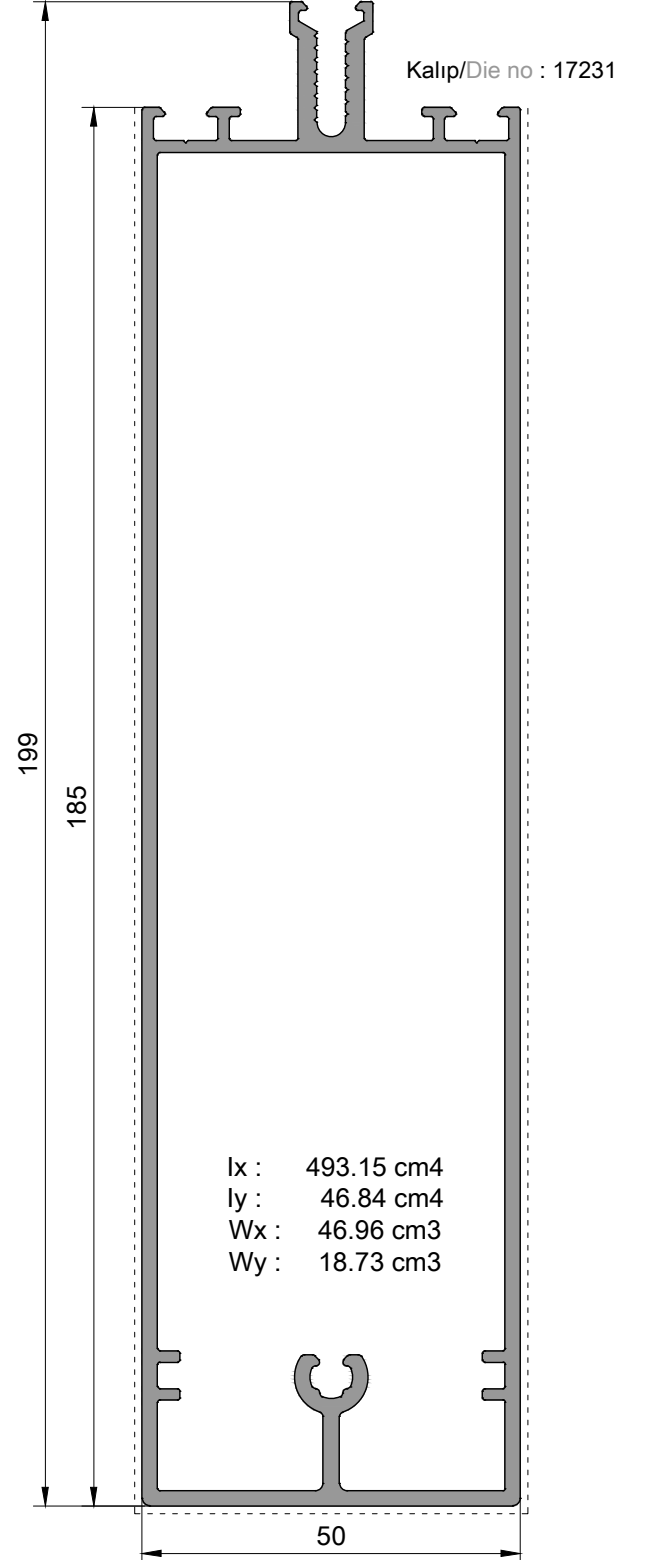

P 1415

200mm YATAY PROFİL

200mm transom profile

Ağırlık/Weight : 2,975 kg/mt

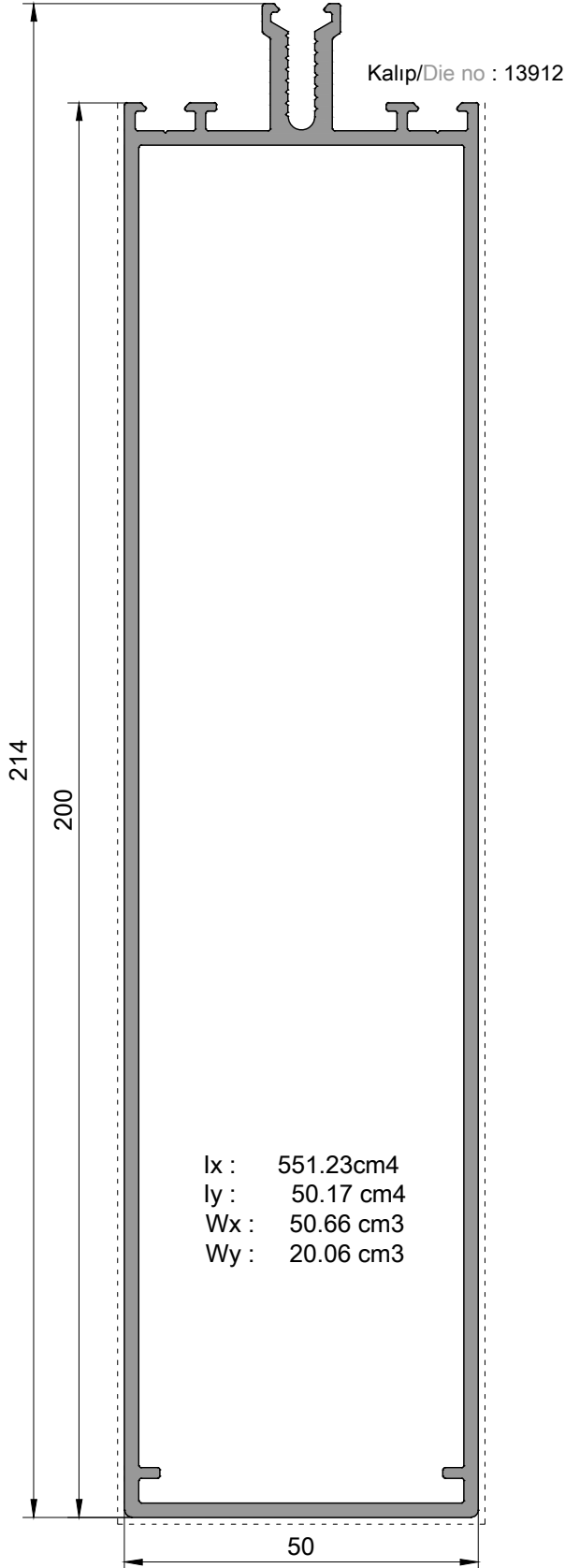

P 1416

210mm YATAY PROFİL

210mm transom profile

Ağırlık/Weight : 4,270 kg/mt

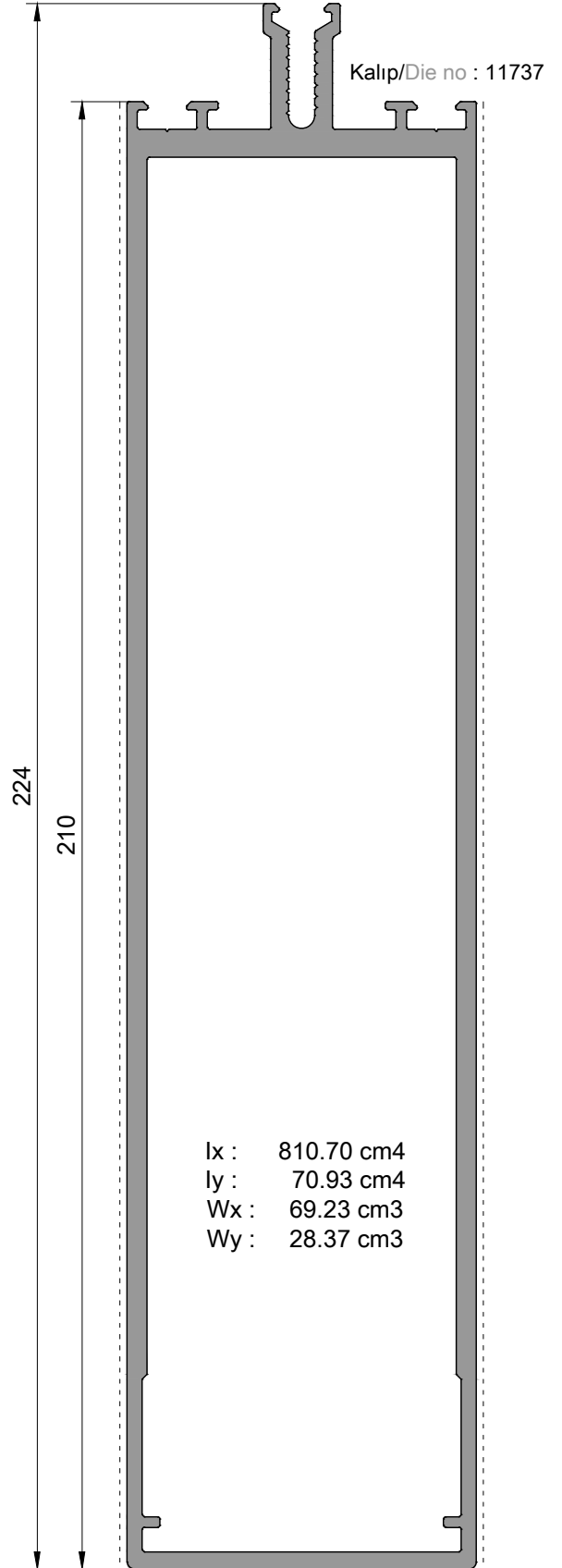

Kalıp/Die no : 9839

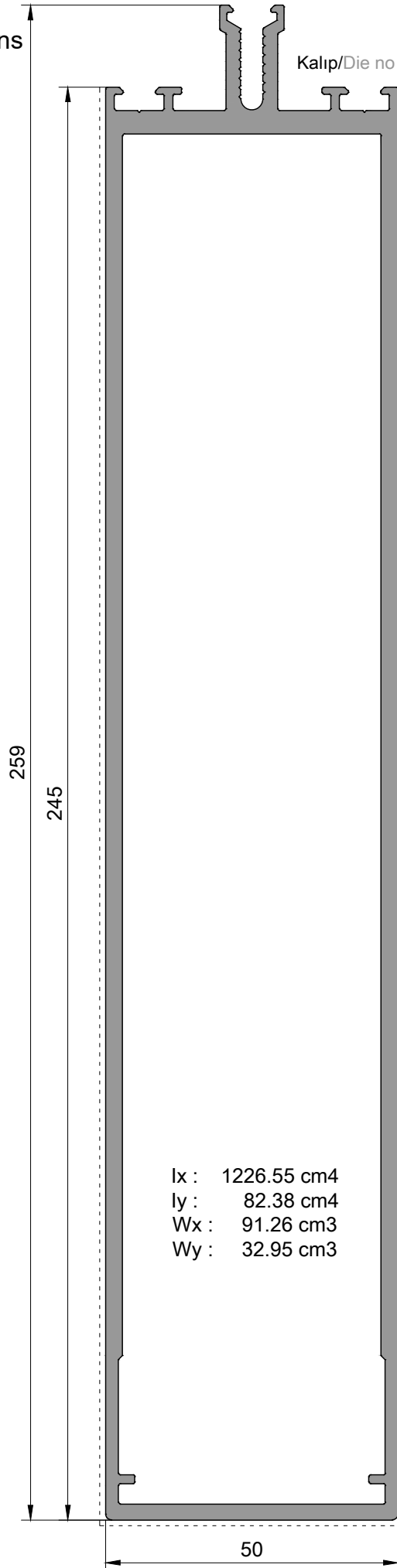

P 1417

245mm YATAY PROFİL

245mm transom profile

Ağırlık/Weight : 4,850 kg/mt

Ix : 1226.55 cm⁴
Iy : 82.38 cm⁴
Wx : 91.26 cm³
Wy : 32.95 cm³

P 1418
DİLATASYON PROFİLİ
dilatation profile
Ağırlık/Weight : 2,240 kg/mt

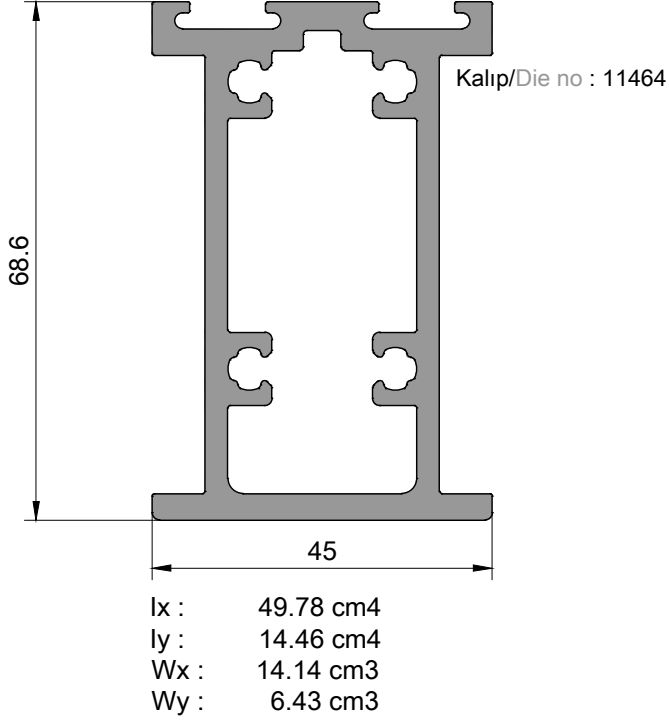

P 1419
DİLATASYON PROFİLİ
dilatation profile
Ağırlık/Weight : 2,485 kg/mt

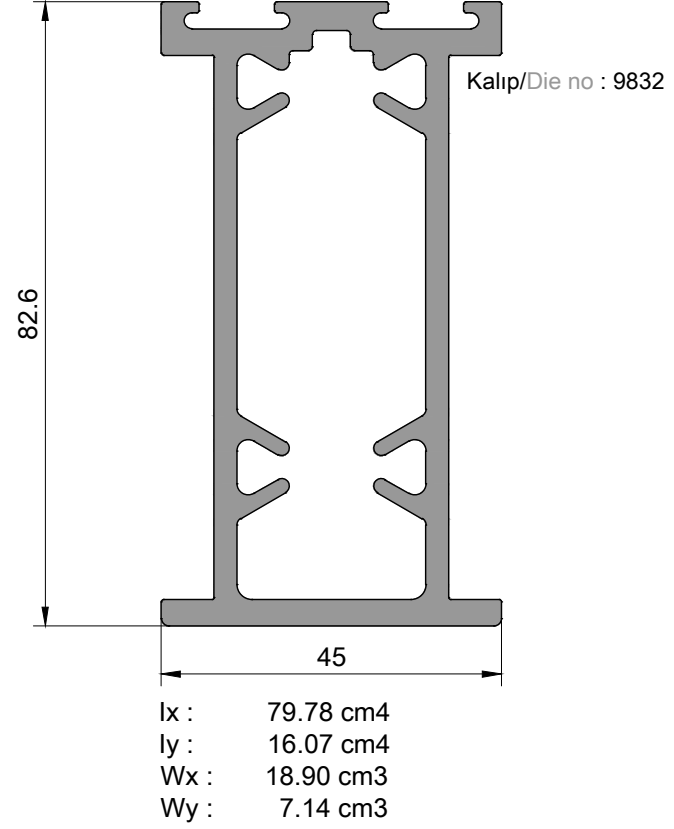

P 1420
DİLATASYON PROFİLİ
dilatation profile
Ağırlık/Weight : 2,650 kg/mt

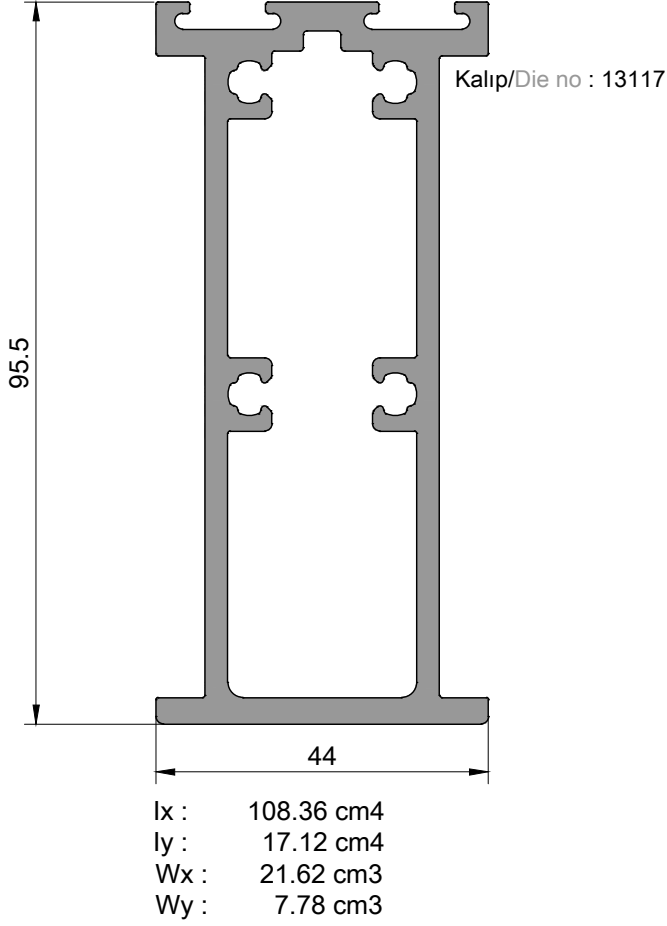

P 1421
DİLATASYON PROFİLİ
dilatation profile
Ağırlık/Weight : 2,840 kg/mt

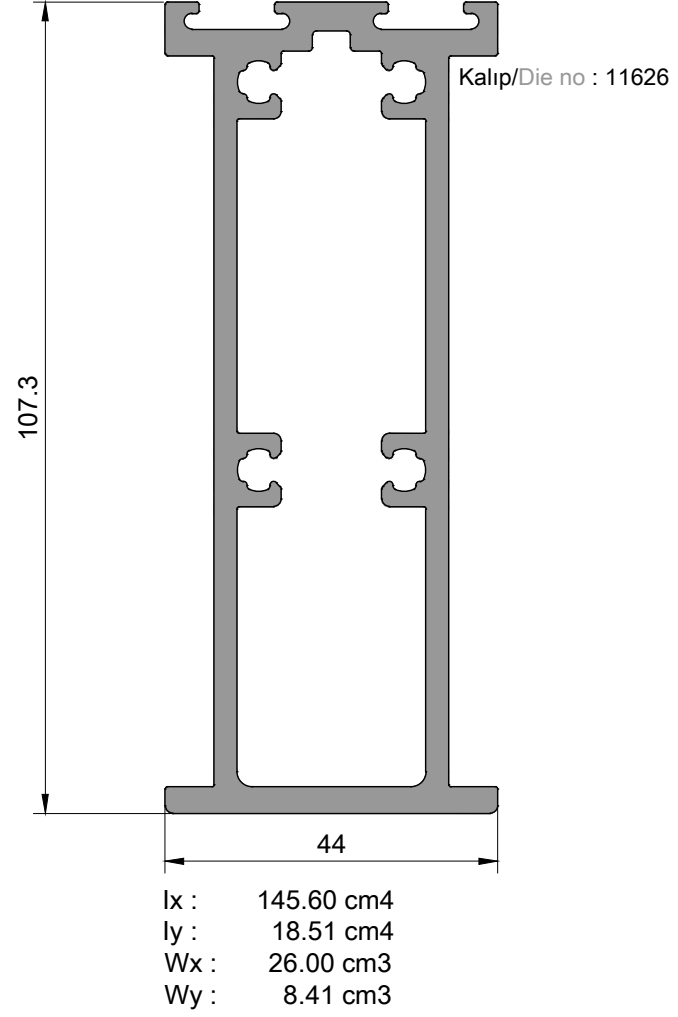

P 1422
DİLATASYON PROFİLİ

dilatation profile

Ağırlık/Weight : 3,410 kg/mt

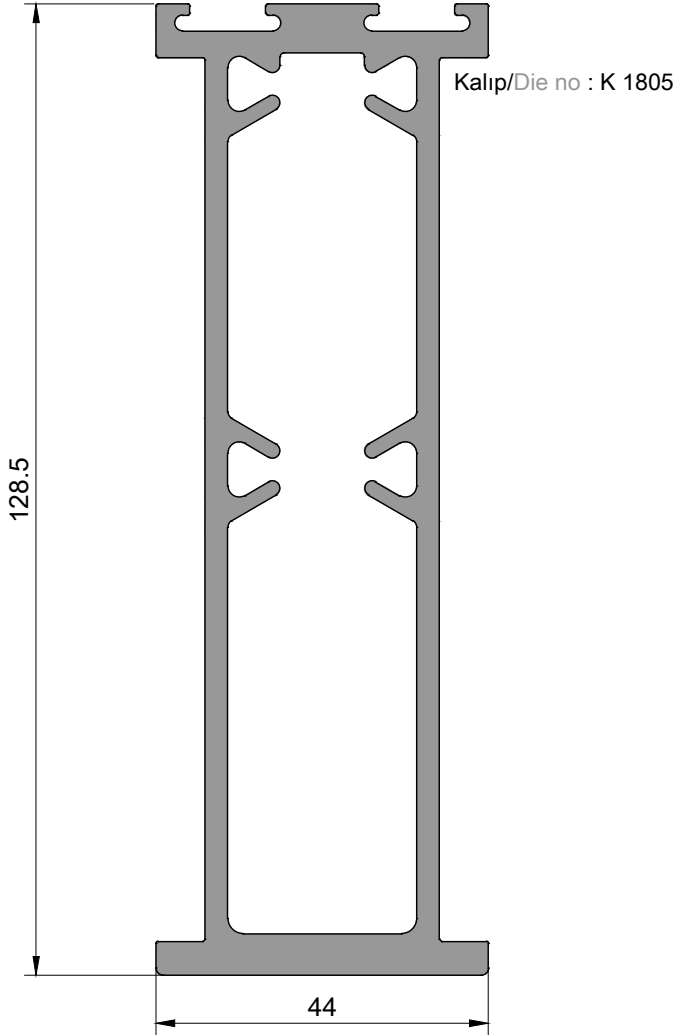

Ix : 256.72 cm⁴
Iy : 21.69 cm⁴
Wx : 39.49 cm³
Wy : 9.86 cm³

P 1423
DİLATASYON PROFİLİ

dilatation profile

Ağırlık/Weight : 7,880 kg/mt

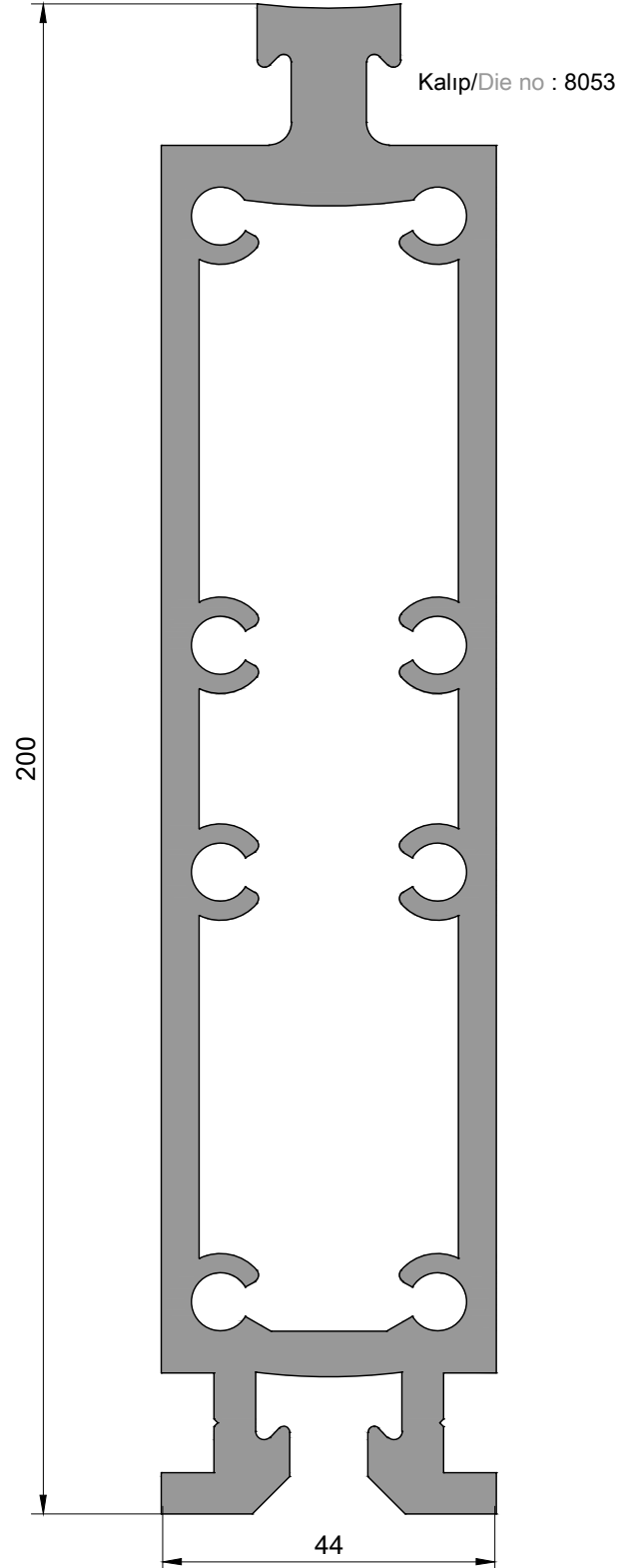

Ix : 1184.31 cm⁴
Iy : 78.26 cm⁴
Wx : 115.64 cm³
Wy : 35.25 cm³

P 1424
YATAY MONTAJ PROFİLİ
transom connector profile
Ağırlık/Weight : 0,945 kg/mt

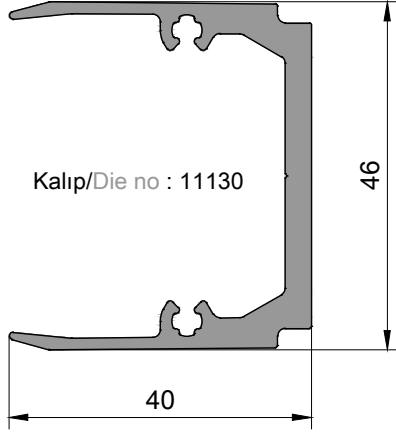

P 1425
YATAY MONTAJ PROFİLİ
transom connector profile
Ağırlık/Weight : 0,920 kg/mt

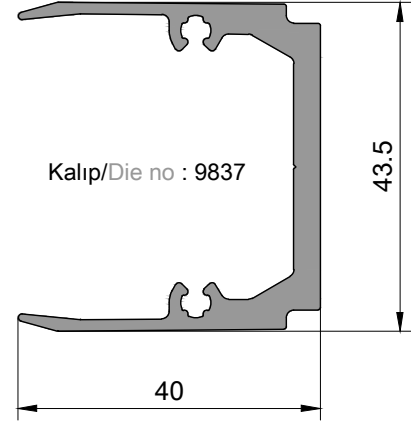

**sadece P1416 ve P1417
yatay profilleri ile kullanılır.
used with P 1416 and P 1417
profiles only

P 1426
AÇILI YATAY MONTAJ PROFİLİ
angular transom connector profile
Ağırlık/Weight : 1,140 kg/mt

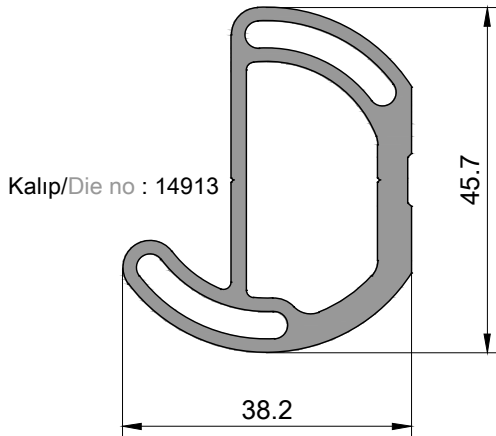

P 1038

BASKI PROFİLİ

pressure plate profile

Ağırlık/Weight : 0,460 kg/mt

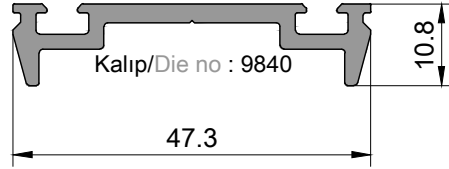

P 1427

BASKI PROFİLİ

pressure plate profile

Ağırlık/Weight : 0,545 kg/mt

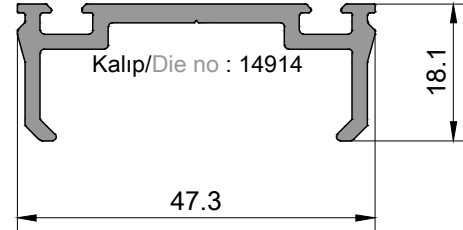

P 1036

KAPAK PROFİLİ

cover profile

Ağırlık/Weight : 0,245 kg/mt

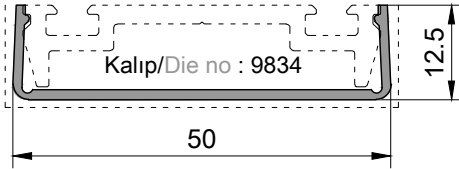

P 1037

KAPAK PROFİLİ

cover profile

Ağırlık/Weight : 0,265 kg/mt

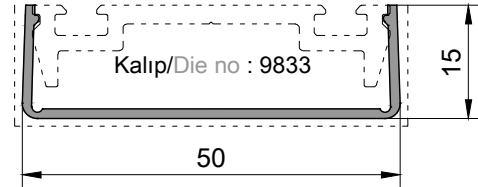

P 1428

KAPAK PROFİLİ

cover profili

Ağırlık/Weight : 0,540 kg/mt

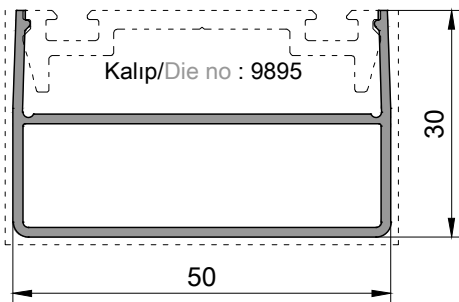

P 1429

KAPAK PROFİLİ

cover profile

Ağırlık/Weight : 0,450 kg/mt

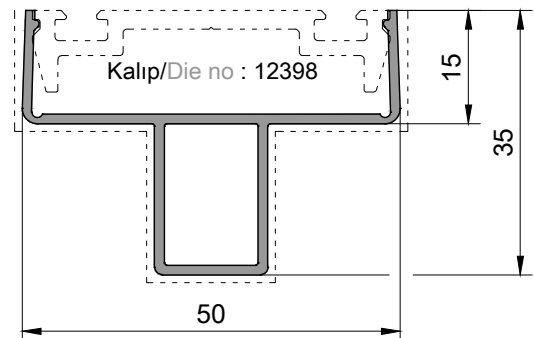

P 1945

KAPAK PROFİLİ

cover profili

Ağırlık/Weight : 0,643 kg/mt

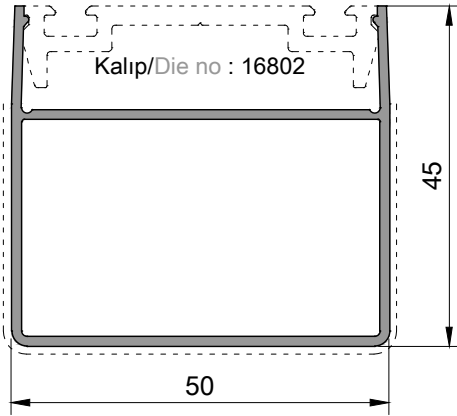

P 1946

KAPAK PROFİLİ

cover profili

Ağırlık/Weight : 0,845 kg/mt

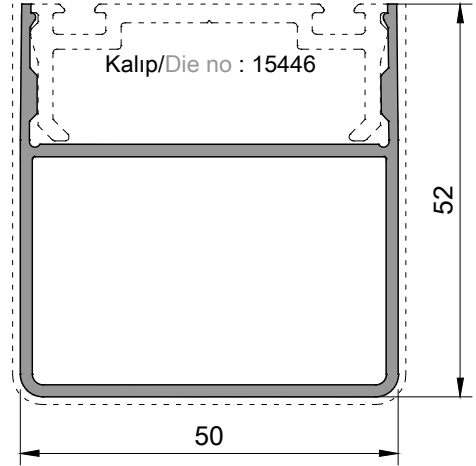

P 1948

KAPAK PROFİLİ

cover profili

Ağırlık/Weight : 1,060 kg/mt

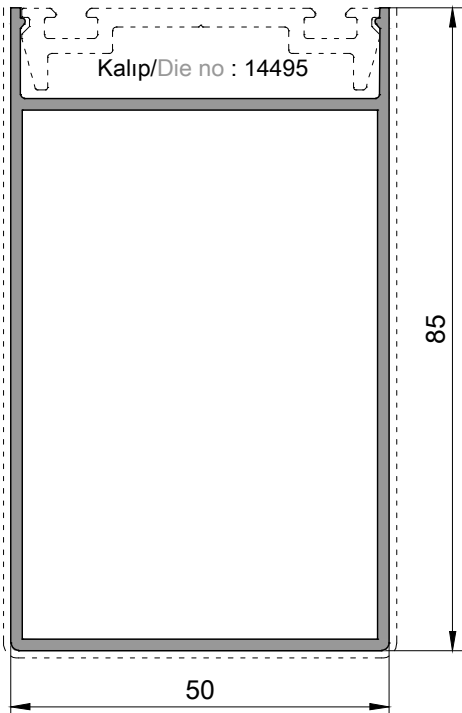

P 1947

KAPAK PROFİLİ

cover profili

Ağırlık/Weight : 1,060 kg/mt

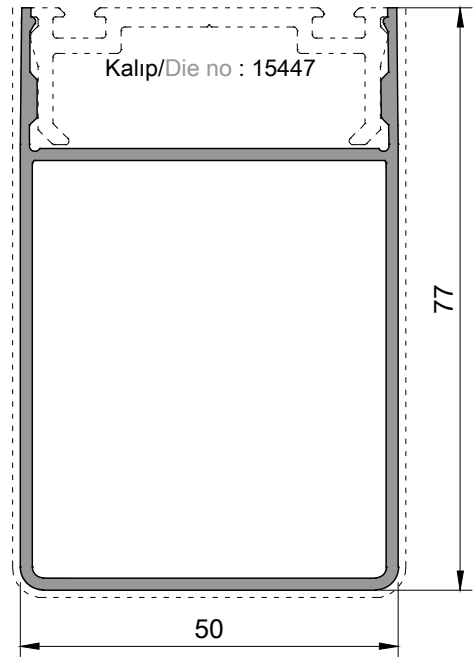

P 1430

KAPAK PROFİLİ

cover profili

Ağırlık/Weight : 1,350 kg/mt

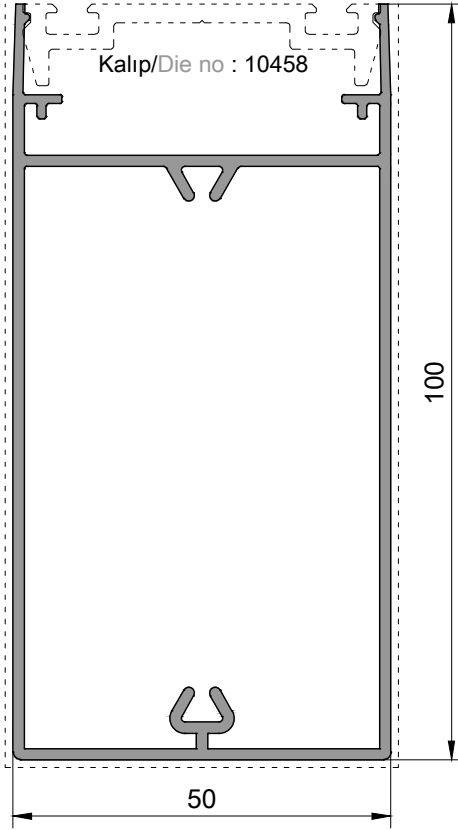

P 1431

KAPAK PROFİLİ

cover profili

Ağırlık/Weight : 2,910 kg/mt

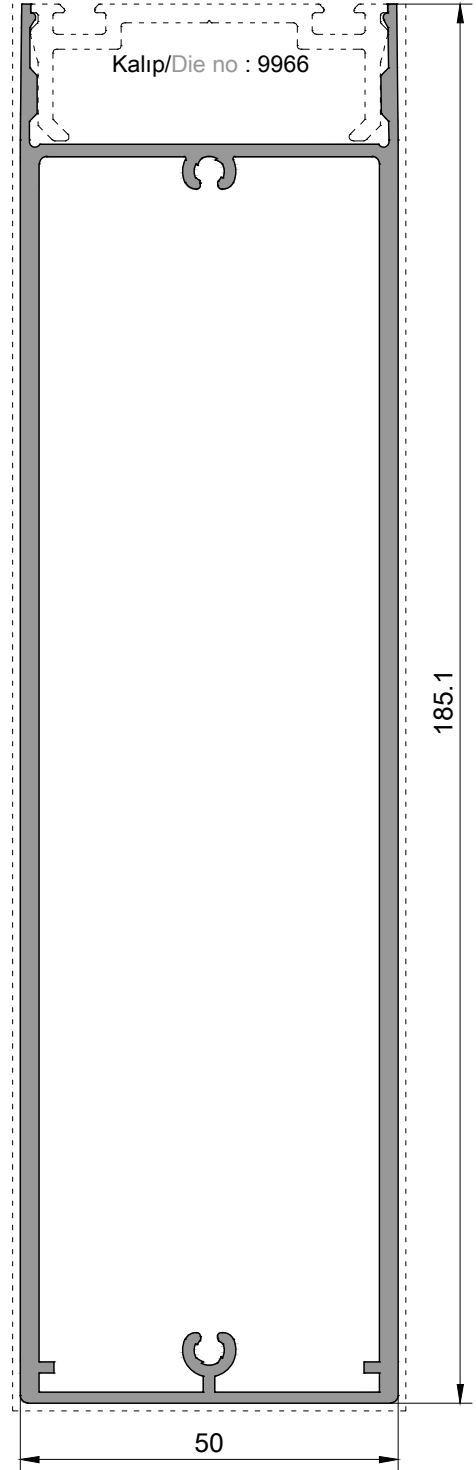

P 1432

90° KÖŞE KAPAK PROFİLİ

90° corner cover profile

Ağırlık/Weight : 1,770 kg/mt

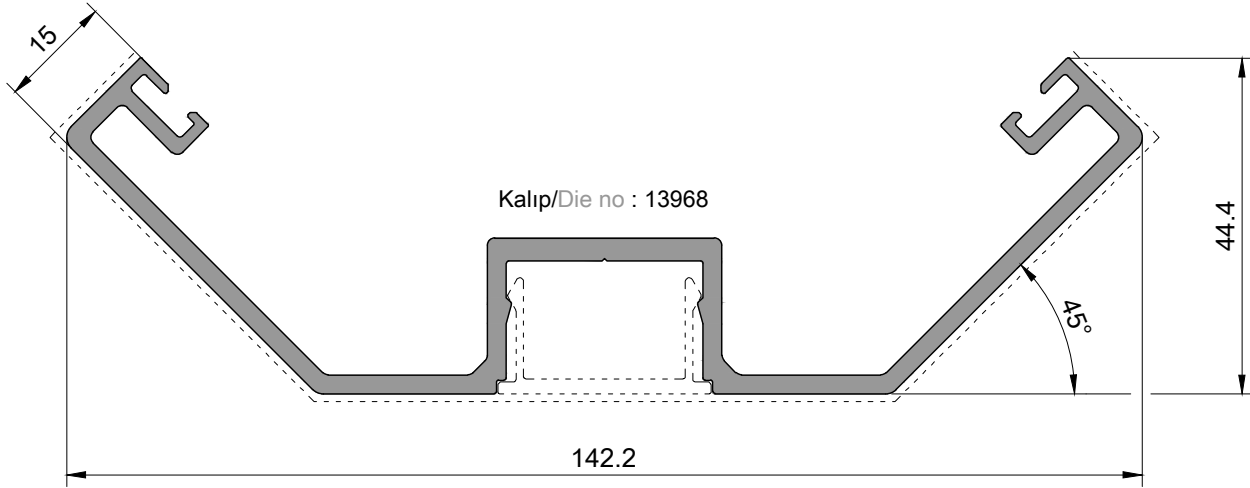

P 1433

KANAL KAPATMA

KAPAK PROFİLİ

cover profile

Ağırlık/Weight : 0,235 kg/mt

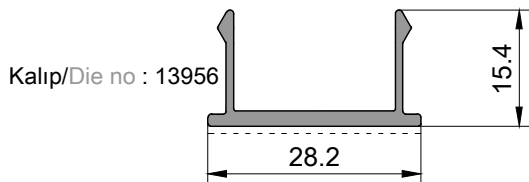

P 1852

H KESİTLİ KAPAK PROFİLİ

h shape cover profile

Ağırlık/Weight : 0,734 kg/mt

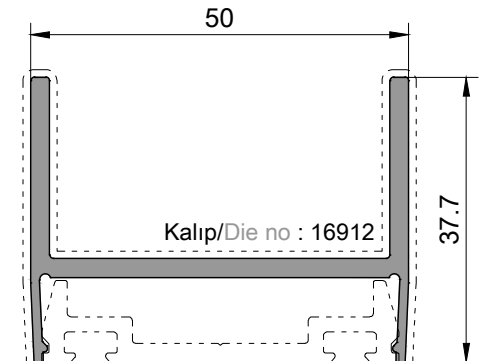

P 1949

90°KÖŞE ADAPTÖR PROFİLİ

90°corner adapter profile

Ağırlık/Weight : 1,195 kg/mt

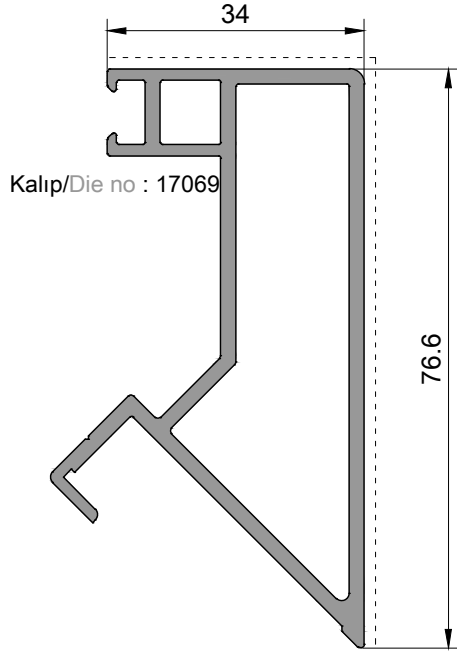

P 1950

ADAPTÖR PROFİLİ

adapter profile

Ağırlık/Weight : 4,390 kg/mt

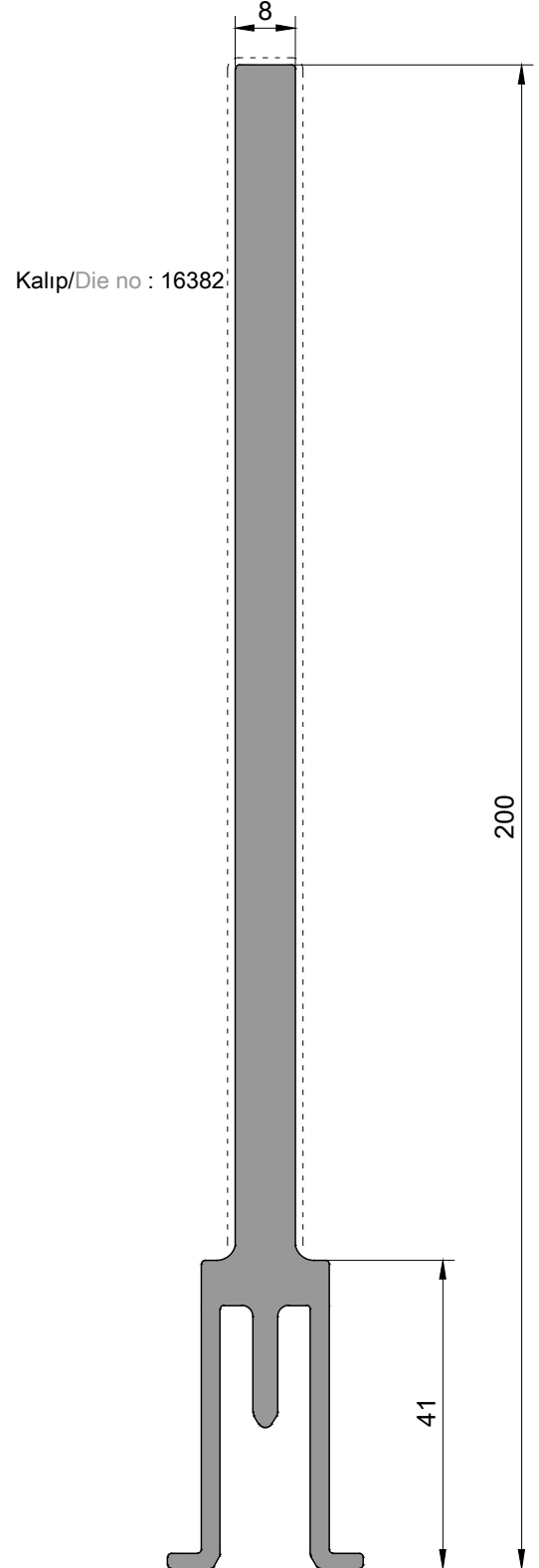

P 1951

CAM TAŞIYICI PROFİL

glass support profile

Ağırlık/Weight : 0,338 kg/mt

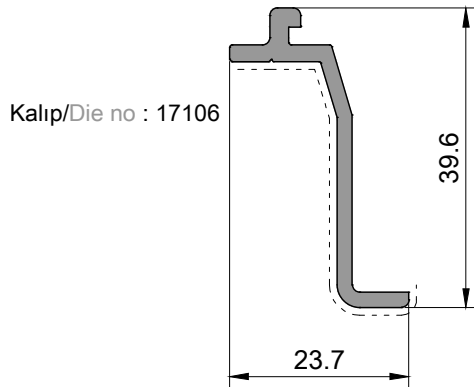

P 1434

CAM YÜKSELTME PROFİLİ

glazing boost profile

Ağırlık/Weight : 0,110 kg/mt

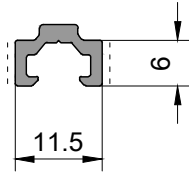

Kalıp/Die no : 10122

P 1435

CAM YÜKSELTME PROFİLİ

glazing boost profile

Ağırlık/Weight : 0,195 kg/mt

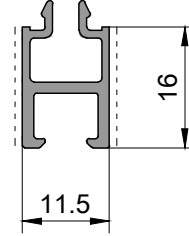

Kalıp/Die no : 11933

P 1436

CAM YÜKSELTME PROFİLİ

glazing boost profile

Ağırlık/Weight : 0,280 kg/mt

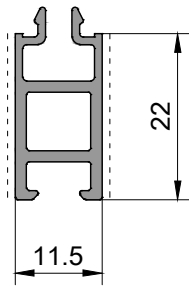

Kalıp/Die no : 11917

P 1437

CAM YÜKSELTME PROFİLİ

glazing boost profile

Ağırlık/Weight : 0,300 kg/mt

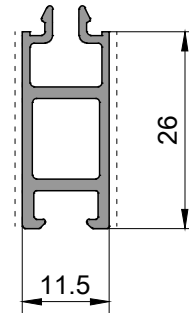

Kalıp/Die no : 12503

P 1439

120° DIŞ KÖŞE ÇITA PROFİLİ

120° exterior corner adapter profile

Ağırlık/Weight : 0,170 kg/mt

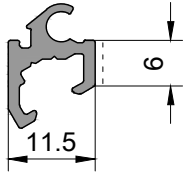

Kalıp/Die no : K 783

P 1440

135° DIŞ KÖŞE ÇITA PROFİLİ

135° exterior corner adapter profile

Ağırlık/Weight : 0,155 kg/mt

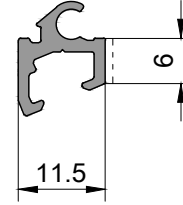

Kalıp/Die no : 11392

P 1441

90° DIŞ KÖŞE ÇITA PROFİLİ

90° exterior adapter profile

Ağırlık/Weight : 0,195 kg/mt

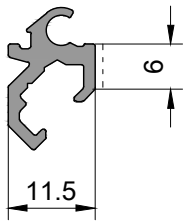

Kalıp/Die no : 11442

P 1851

CAM TAŞIYICI PROFİL

glass support profile

Ağırlık /Weight: 0,251 kg/mt

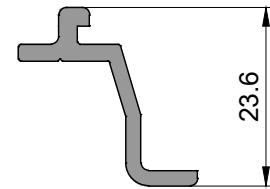

Kalıp/Die no : 16612

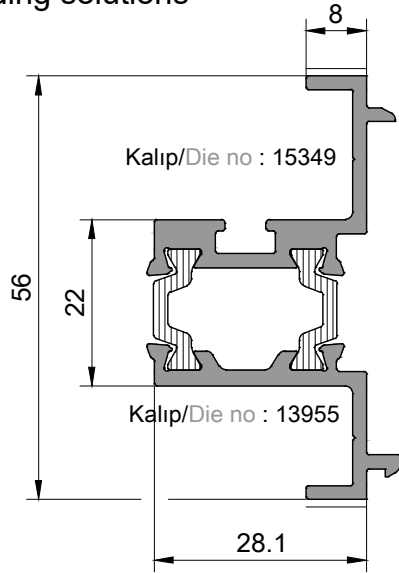

P 1515
BASIC56 PENCERE
ADAPTÖR PROFİLİ
adapter profile for
basic56 window
Ağırlık/Weight : 0,935 kg/mt

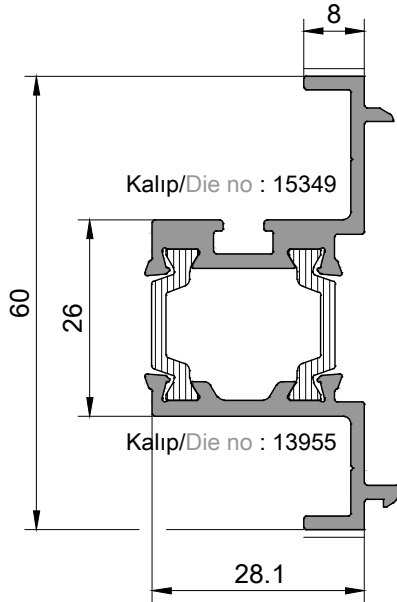

P 1531
BASIC60 PENCERE
ADAPTÖR PROFİLİ
adapter profile for
basic60 window
Ağırlık/Weight : 0,955 kg/mt

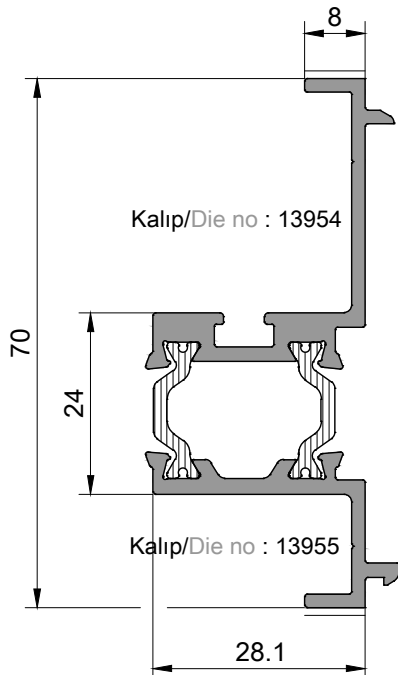

P 1220
ICON70 PENCERE
ADAPTÖR PROFİLİ
adapter profile for
icon70 window
Ağırlık/Weight : 0,985 kg/mt

P 1442

VASİSTAS PENCERE

KASA PROFİLİ

frame profile for top hung window

(kapaklı cephe için)

(cover facade for profile)

Ağırlık/Weight : 1,735 kg/mt

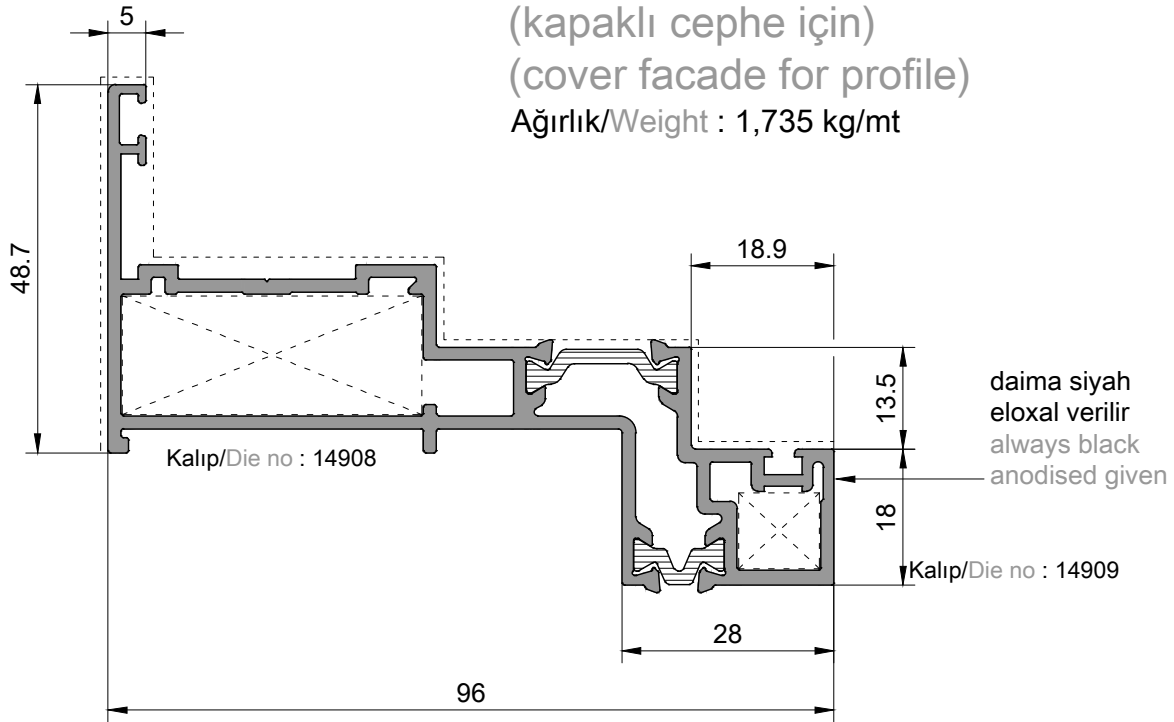

P 1443

VASİSTAS PENCERE

KASA PROFİLİ

frame profile for top hung window

(yarı kapaklı ve silikon cephe için)

(for half cappet facade&silicone facade)

Ağırlık/Weight : 1,590 kg/mt

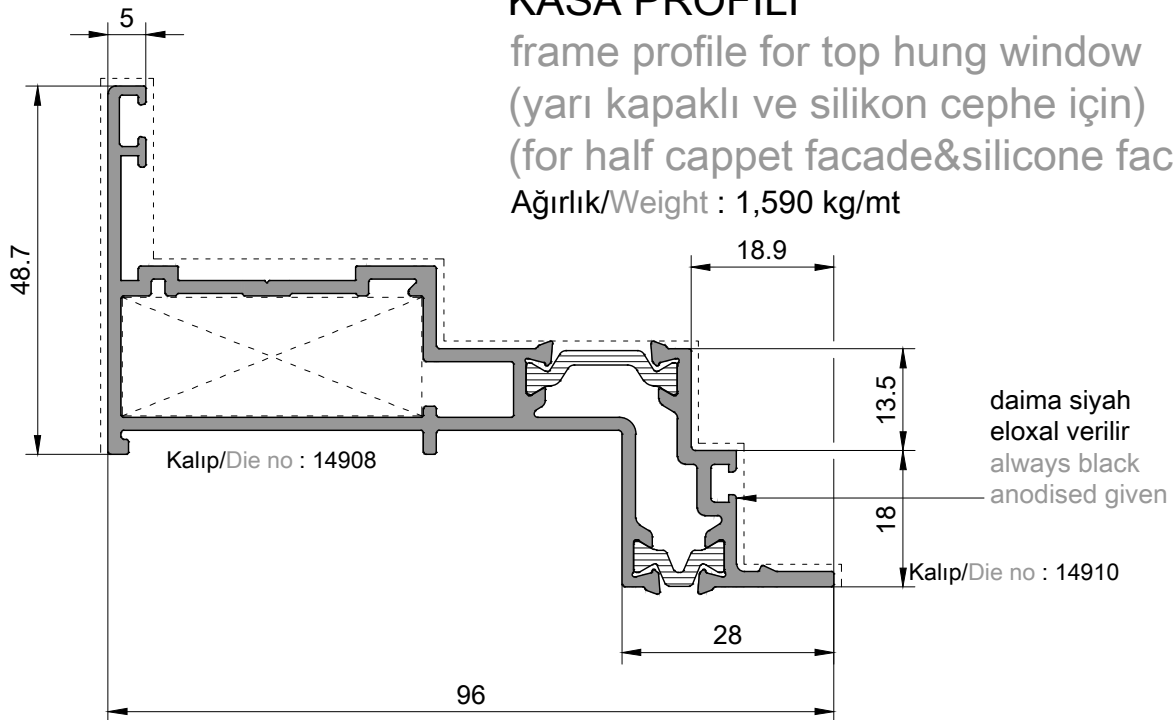

P 1444

**VASİSTAS PENCERE
KANAT PROFİLİ**

sash profile for top hung window
(36mm ve üzeri camlar için)
(36mm glass or above)

Ağırlık/Weight : 1,450 kg/mt

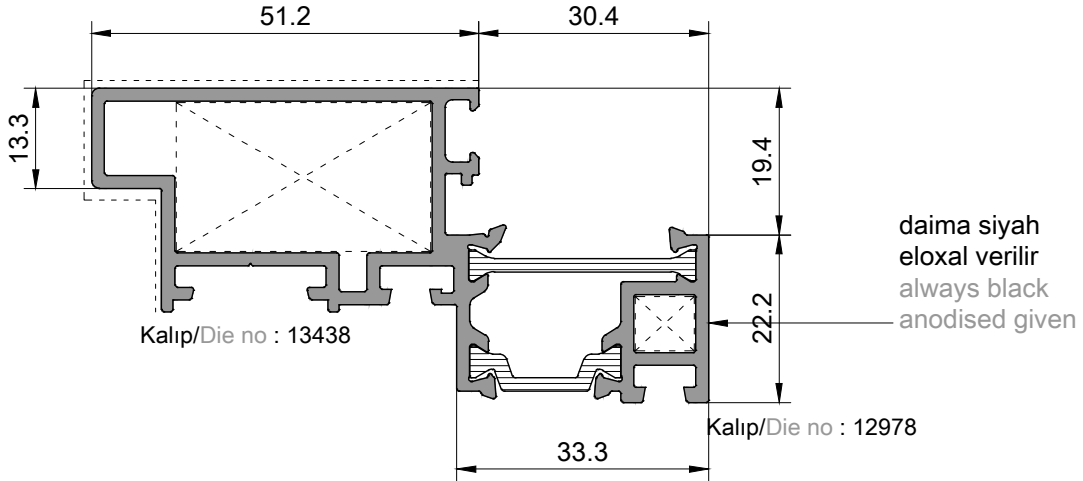

P 1004

**VASİSTAS PENCERE
KANAT PROFİLİ**

sash profile for top hung window
(34mm ye kadar olan camlar için)
(till 34mm glass)

Ağırlık/Weight : 1,510 kg/mt

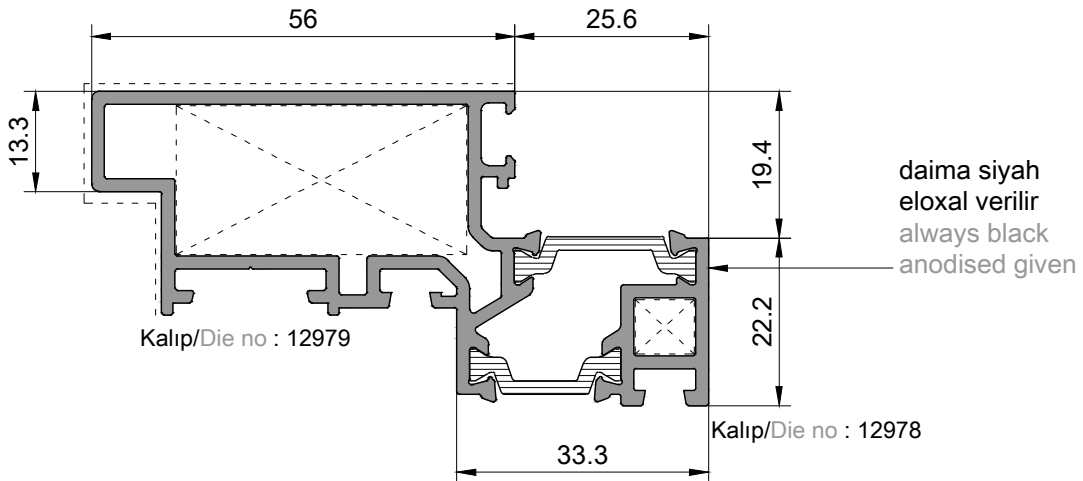

P 1445
CAM TAŞIYICI PROFİL
glass support profile
Ağırlık/Weight : 0,235 kg/mt

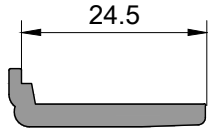

Kalıp/Die no : 10148

P 1446
CAM TAŞIYICI PROFİL
glass support profile
Ağırlık/Weight : 0,280 kg/mt

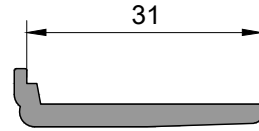

Kalıp/Die no : 10147

P 1447
CAM TAŞIYICI PROFİL
glass support profile
Ağırlık/Weight : 0,355 kg/mt

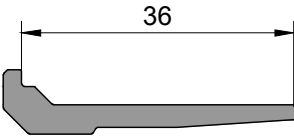

Kalıp/Die no : 14124

P 1448
CAM TAŞIYICI PROFİL
glass support profile
Ağırlık/Weight : 0,385 kg/mt

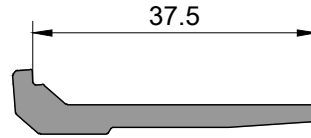

Kalıp/Die no : 13121

P 1449
CAM TAŞIYICI PROFİL
glass support profile
Ağırlık/Weight : 0,405 kg/mt

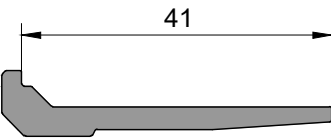

Kalıp/Die no : 14-2957

P 1450
CAM TAŞIYICI PROFİL
glass support profile
Ağırlık/Weight : 0,755 kg/mt

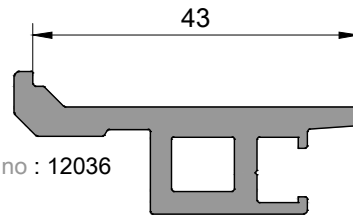

Kalıp/Die no : 12036

P 1451

CAM TAŞIYICI PROFİL

glass support profile

Ağırlık/Weight : 0,505 kg/mt

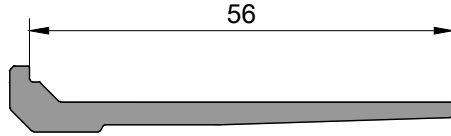

Kalıp/Die no : 11918

P 1452

TEK CAM KASET PROFİLİ

frame profile for single glass

(siyah eloxal)

(black anodised)

Ağırlık/Weight : 0,355 kg/mt

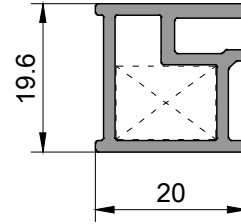

Kalıp/Die no : 12767

P 1013

CAM TAŞIYICI PROFİL

glass support profile

(vasistas kanat için)

Ağırlık/Weight : 0,260 kg/mt

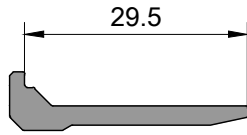

Kalıp/Die no : 12715

P 1015

KÖŞE TAKOZ PROFİLİ

corner wedge profile

Ağırlık/Weight : 5,990 kg/mt

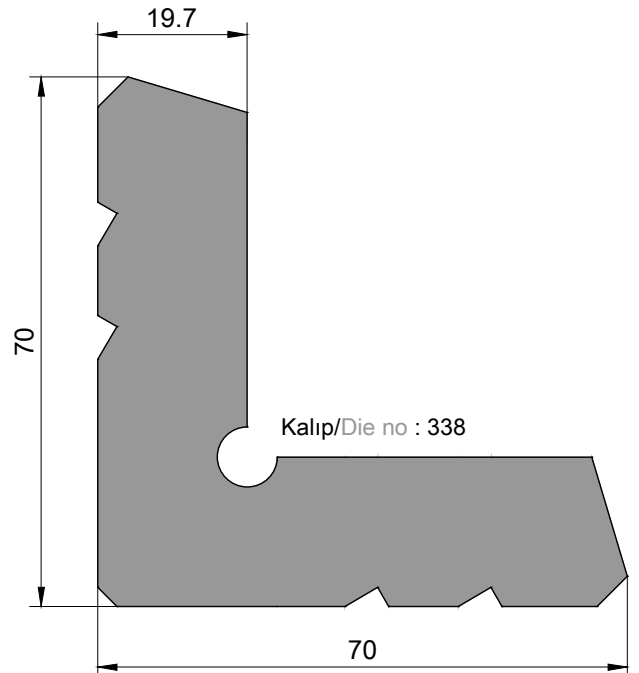

Kalıp/Die no : 338

P 1020

TİJ PROFİLİ

rod profile

(siyah yada mat eloxal)

(black and anodised)

Ağırlık/Weight : 0,105 kg/mt

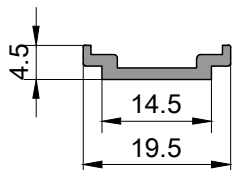

Kalıp/Die no : 12769

P 1453

TEK CAM KASET PROFİLİ
frame profile for single glass
(siyah eloxal)

(black anodised)

Ağırlık/Weight : 0,370 kg/mt

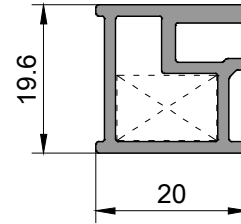

Kalıp/Die no : 14946

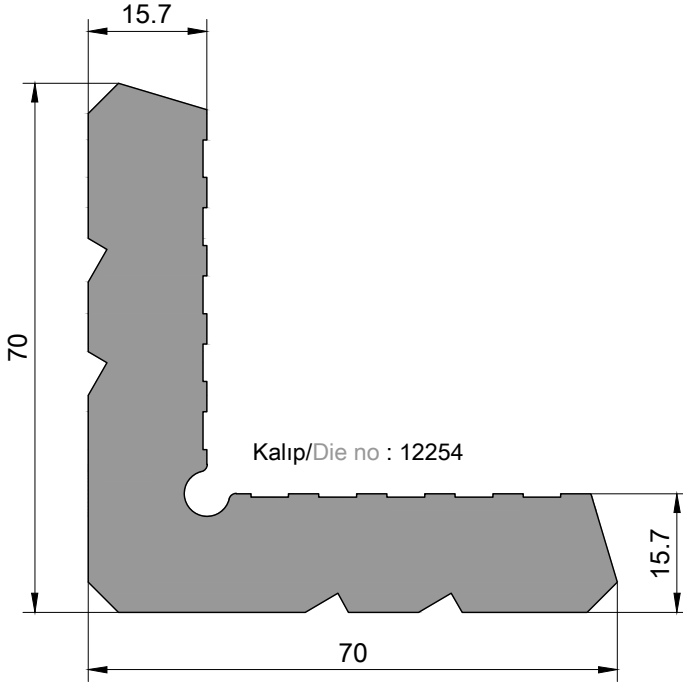

Kalıp/Die no : 12254

P 1016

KÖŞE TAKOZ PROFİLİ
corner wedge profile

Ağırlık/Weight : 4,910 kg/mt

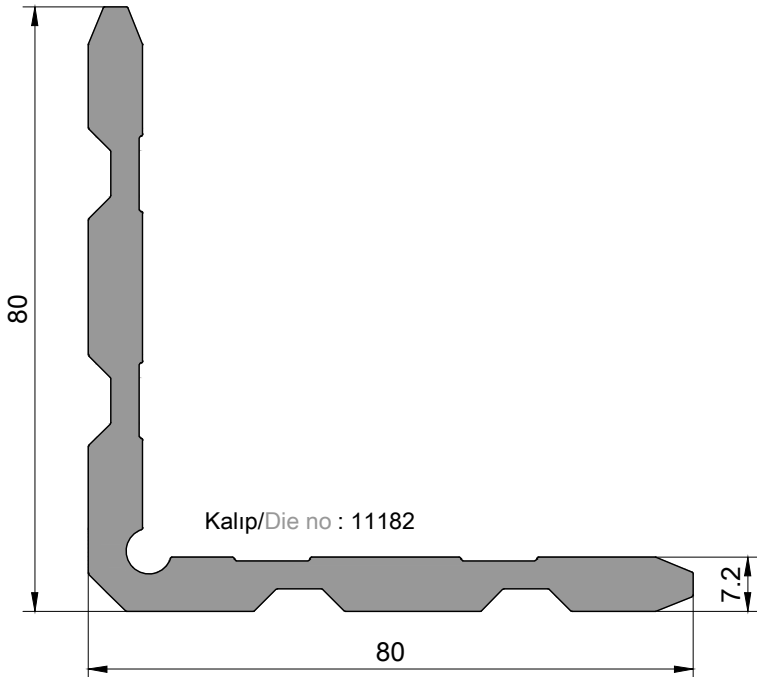

Kalıp/Die no : 11182

P 1017

KÖŞE TAKOZ PROFİLİ
corner wedge profile

Ağırlık/Weight : 2,505 kg/mt

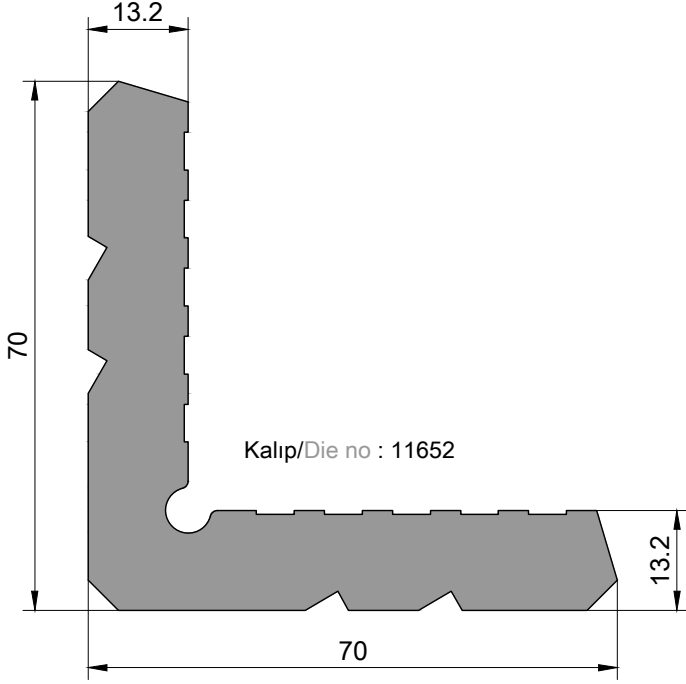

P 1069
KÖŞE TAKOZ PROFİLİ
corner wedge profile
Ağırlık/Weight : 4,200 kg/mt

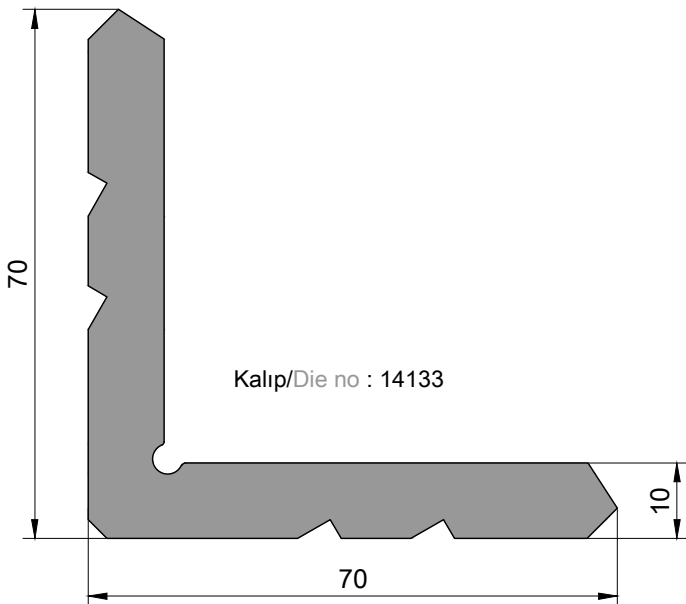

P 1288
KÖŞE TAKOZ PROFİLİ
corner wedge profile
Ağırlık/Weight : 3,310 kg/mt

FS50
STICK GİYDİRME CEPHE SİSTEMİ
STICK CURTAIN WALL SYSTEM

KAPAKLI CEPHE
SİSTEM DETAYLARI
CAPPED FACADE SYSTEM DETAILS

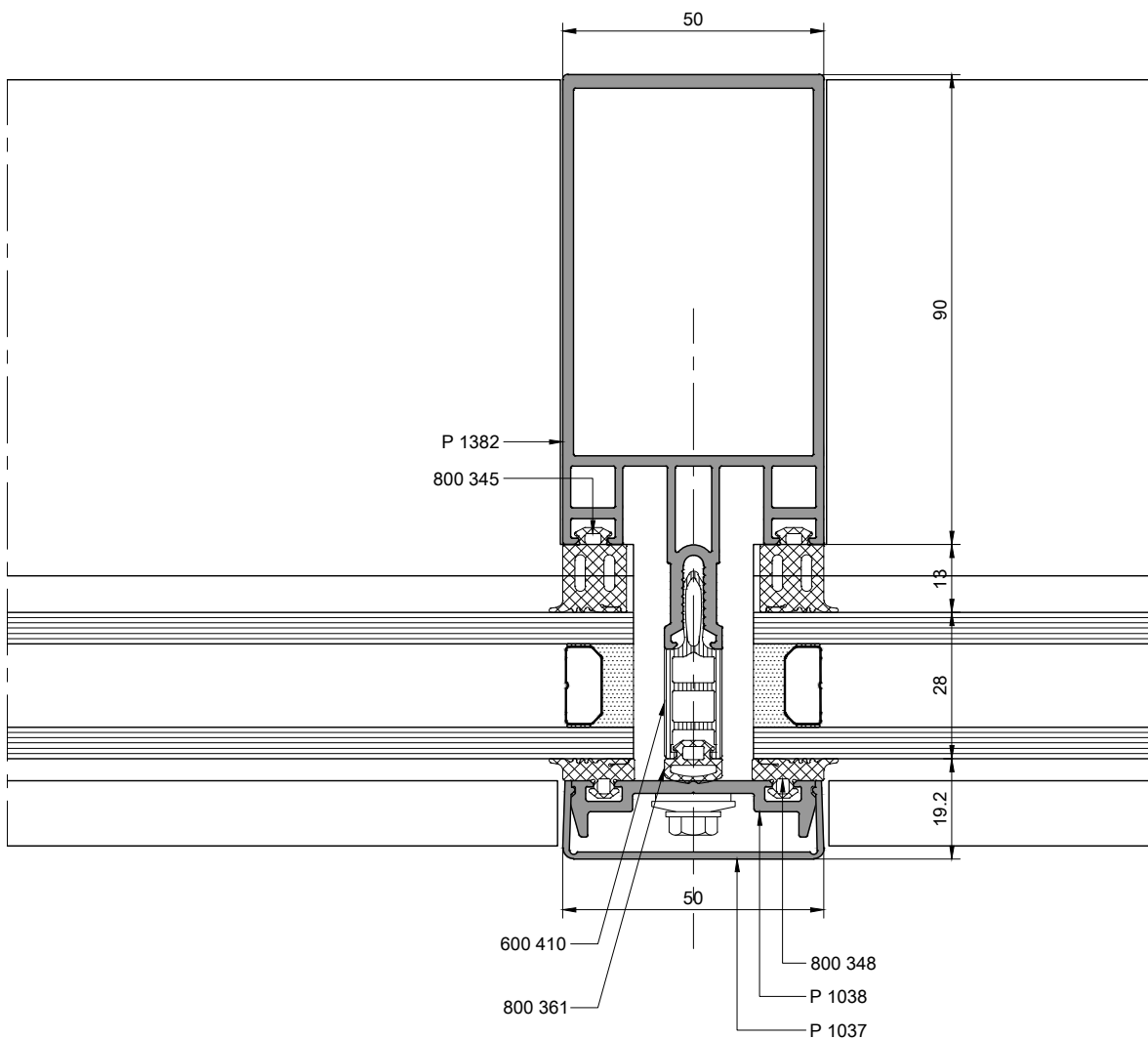
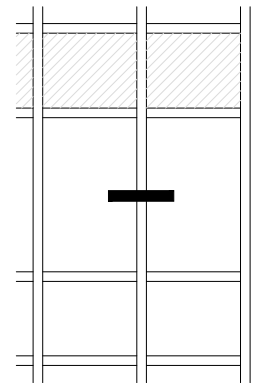

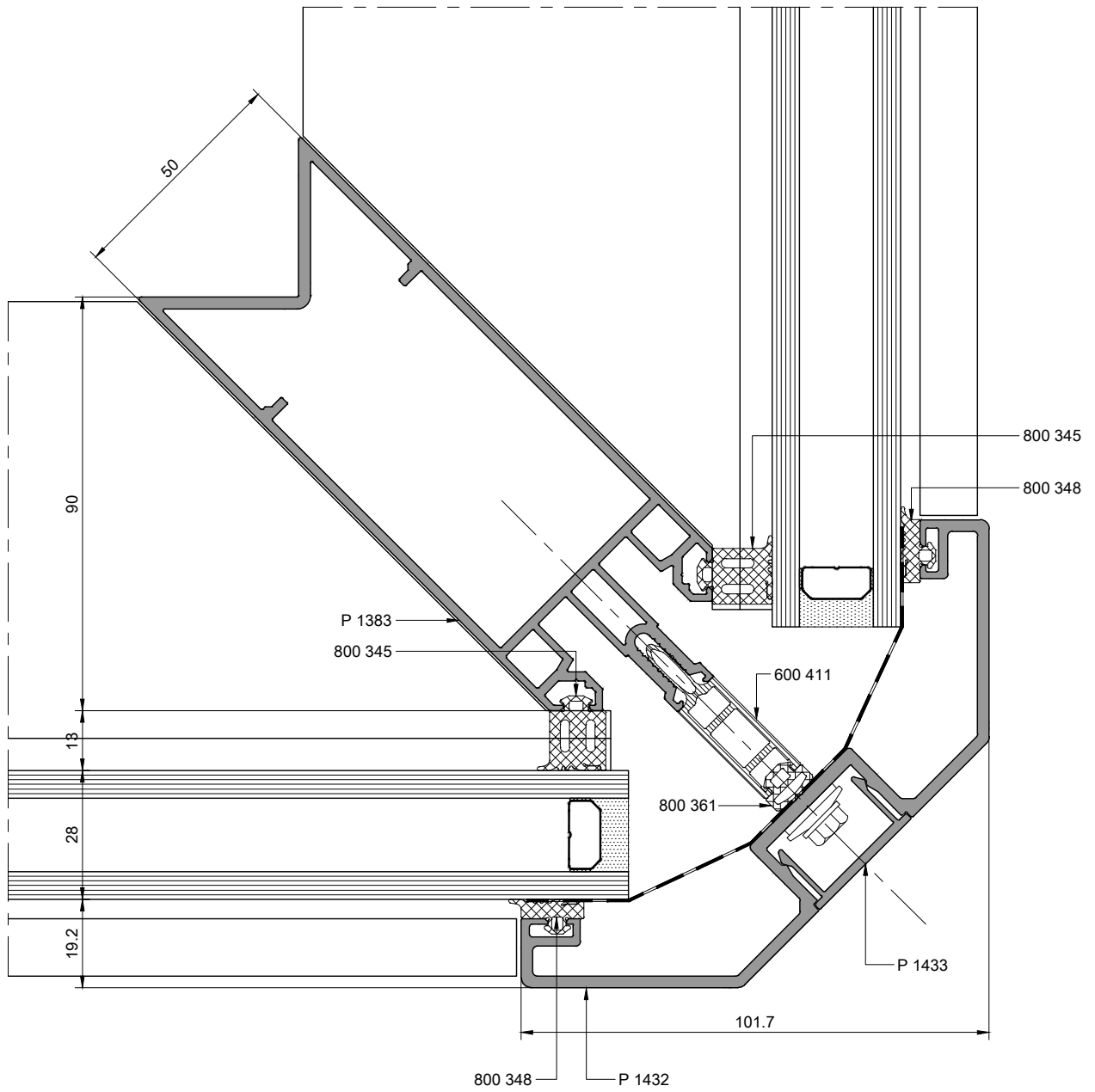
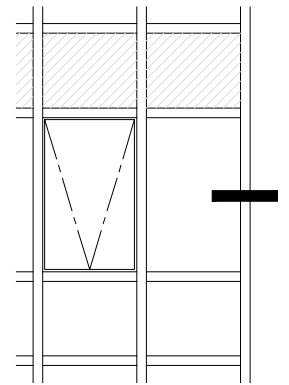

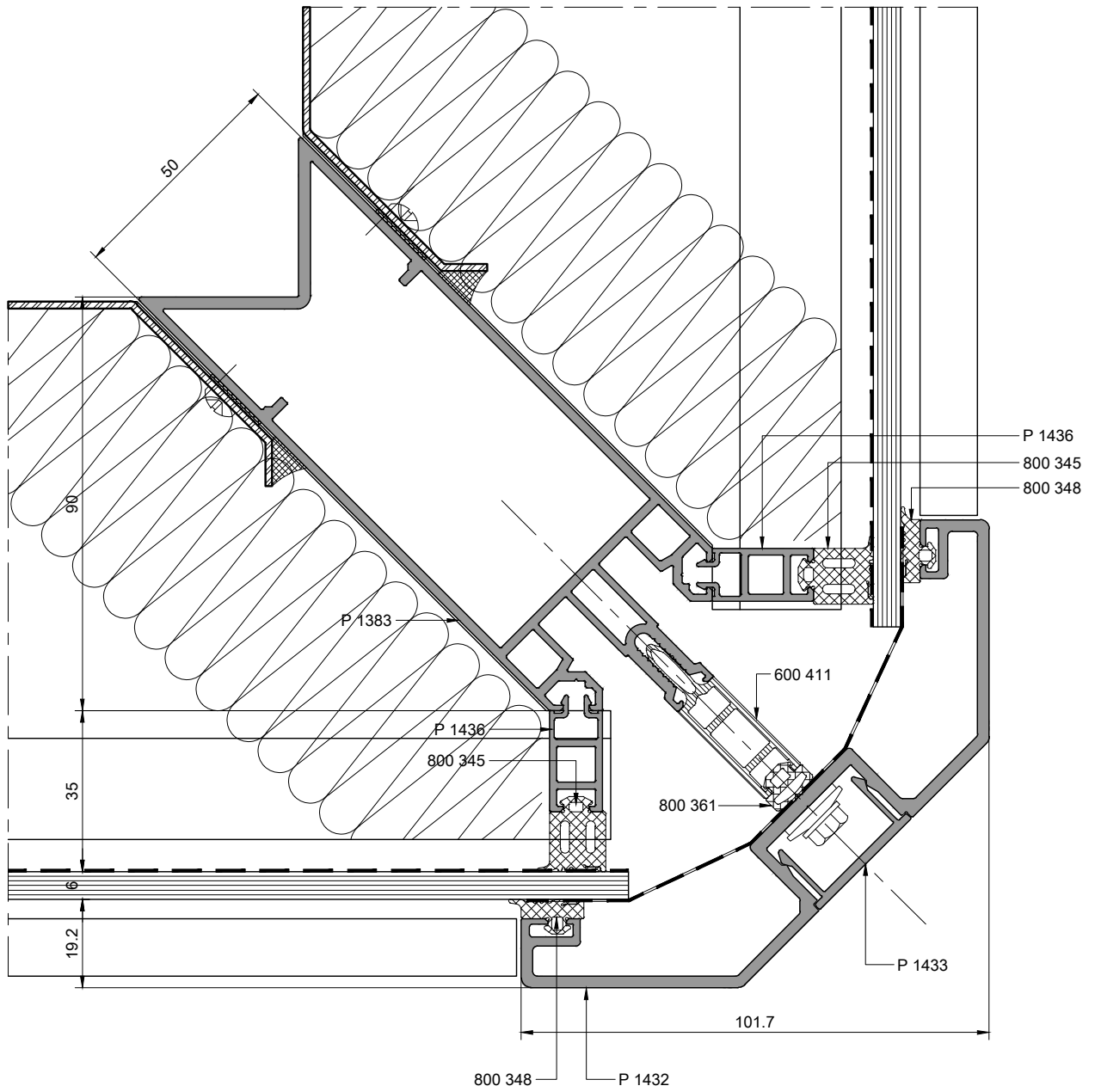
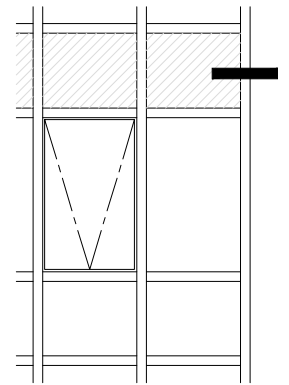

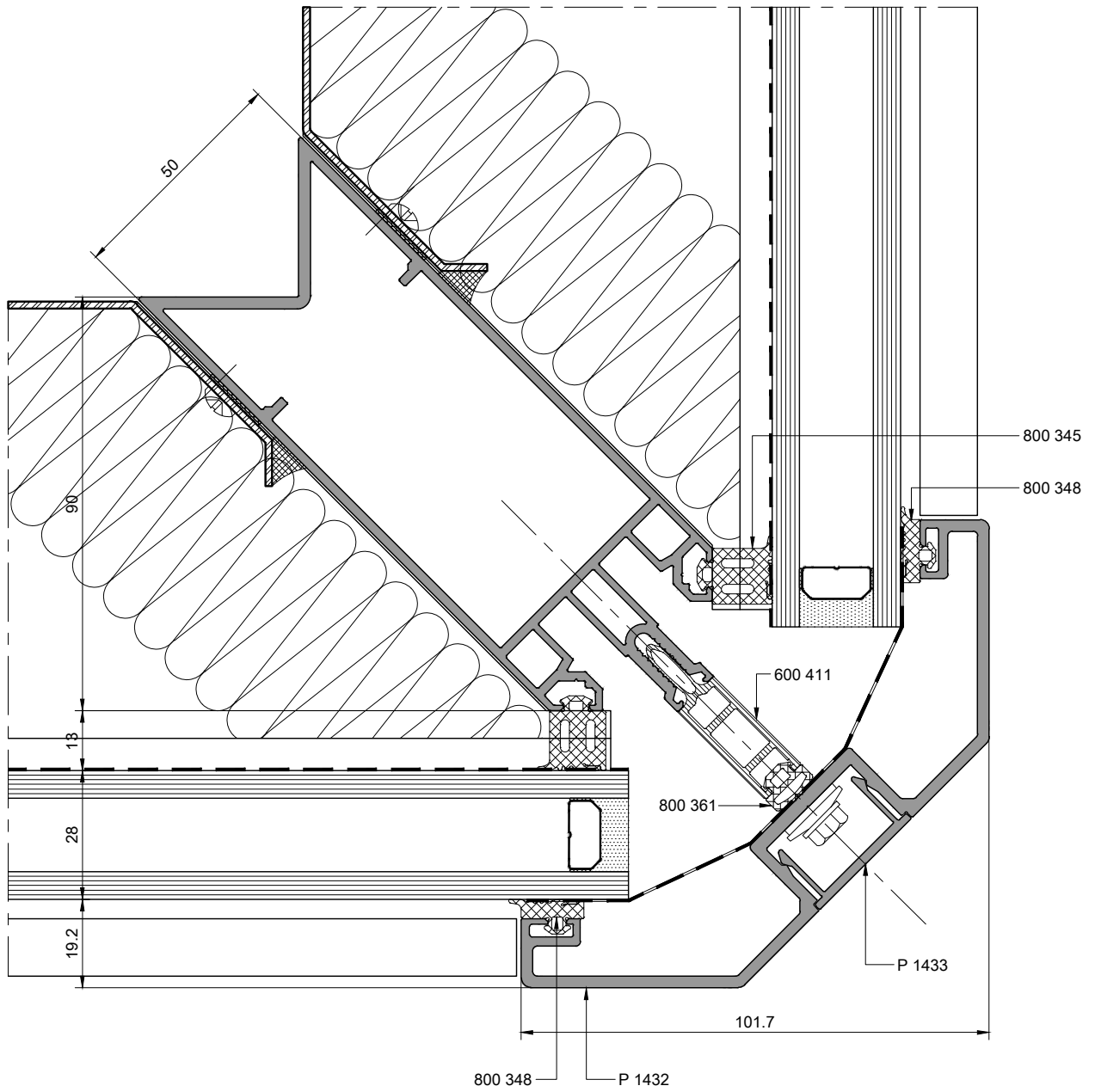
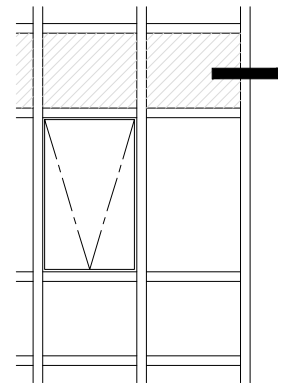

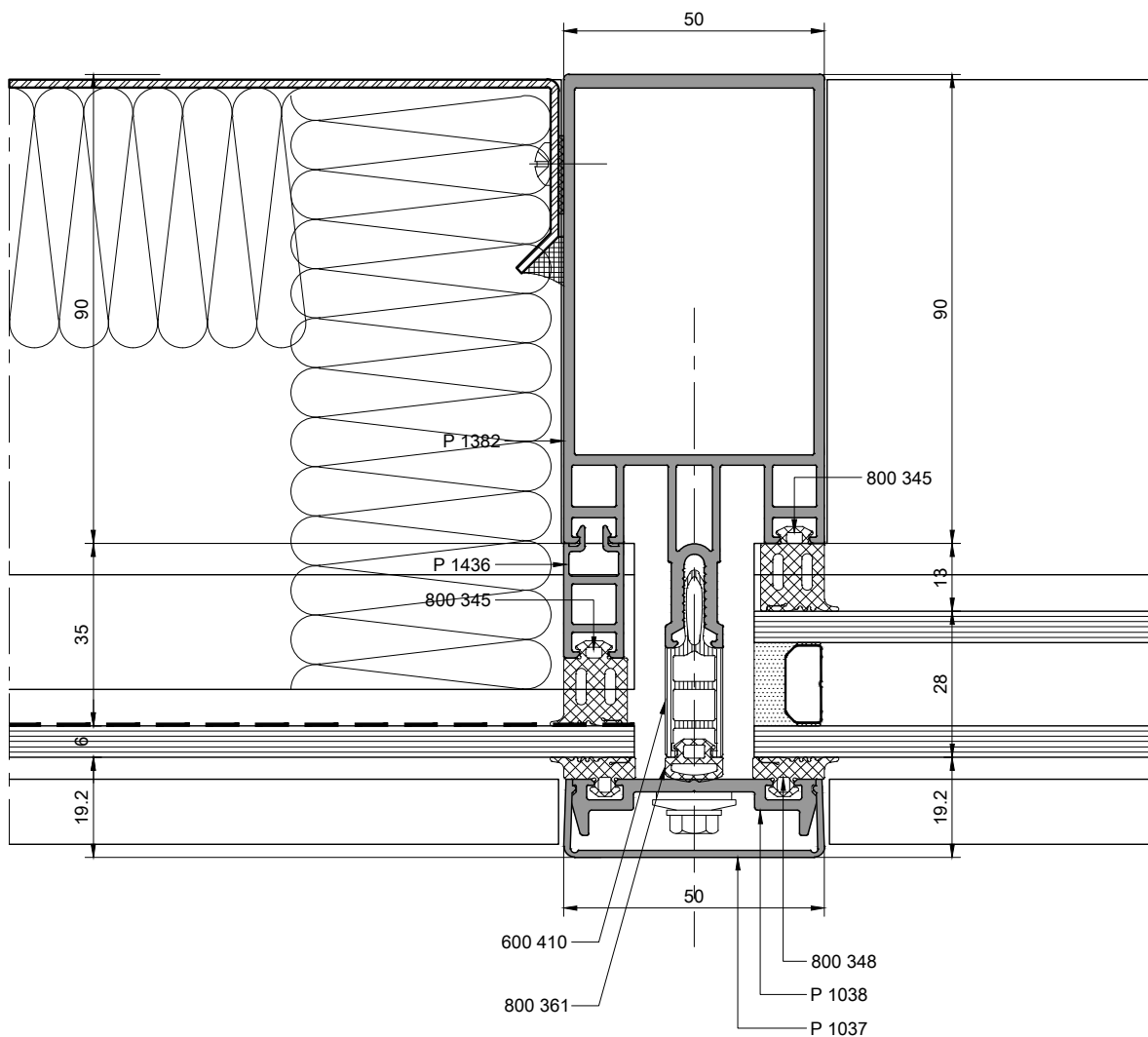
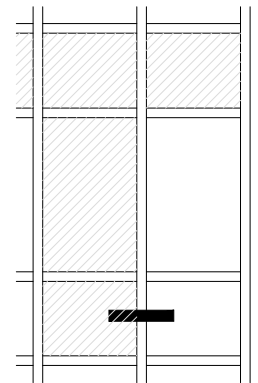

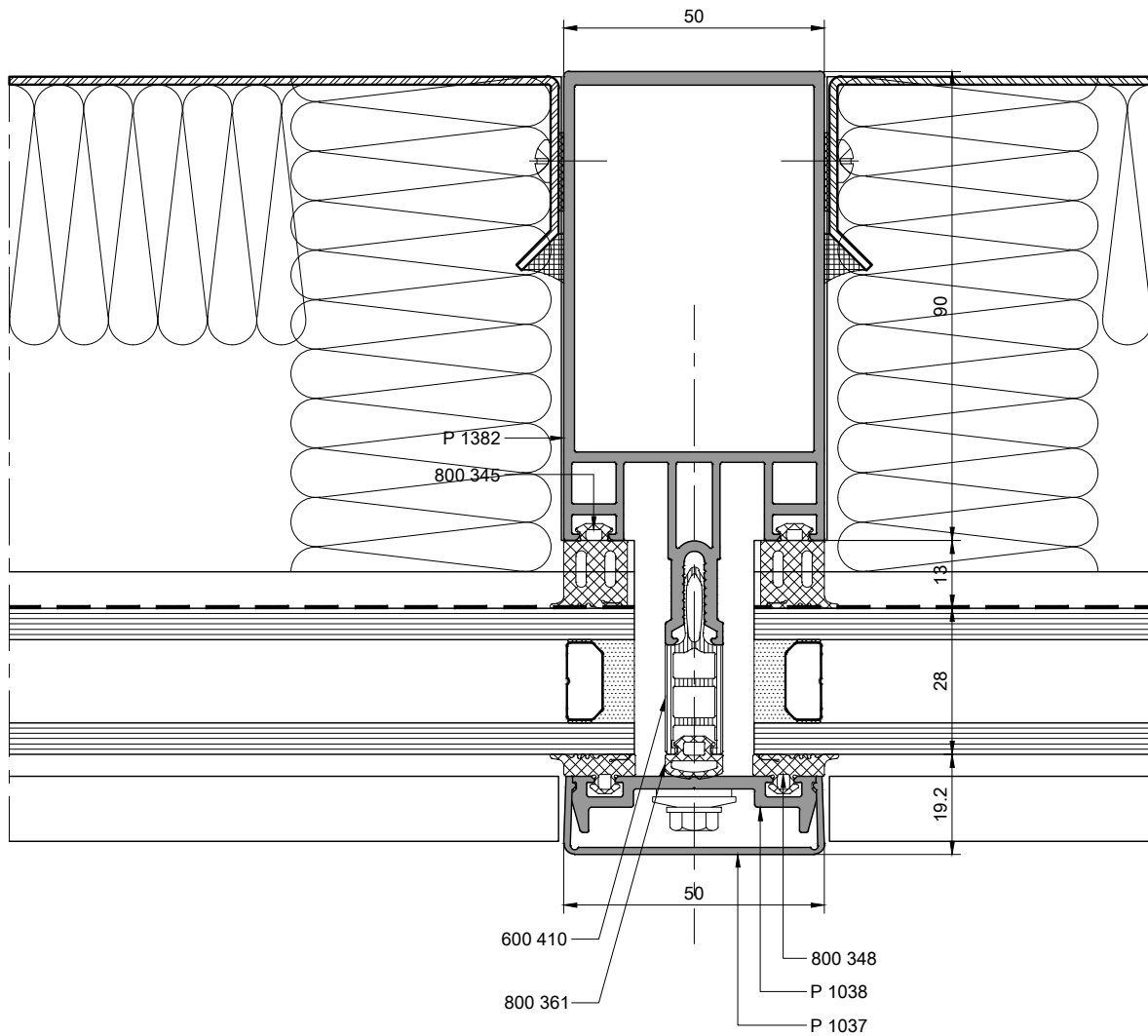
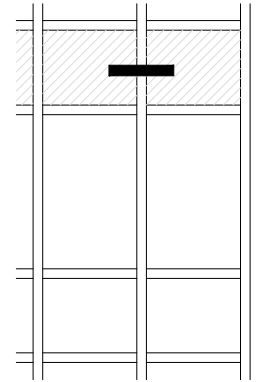

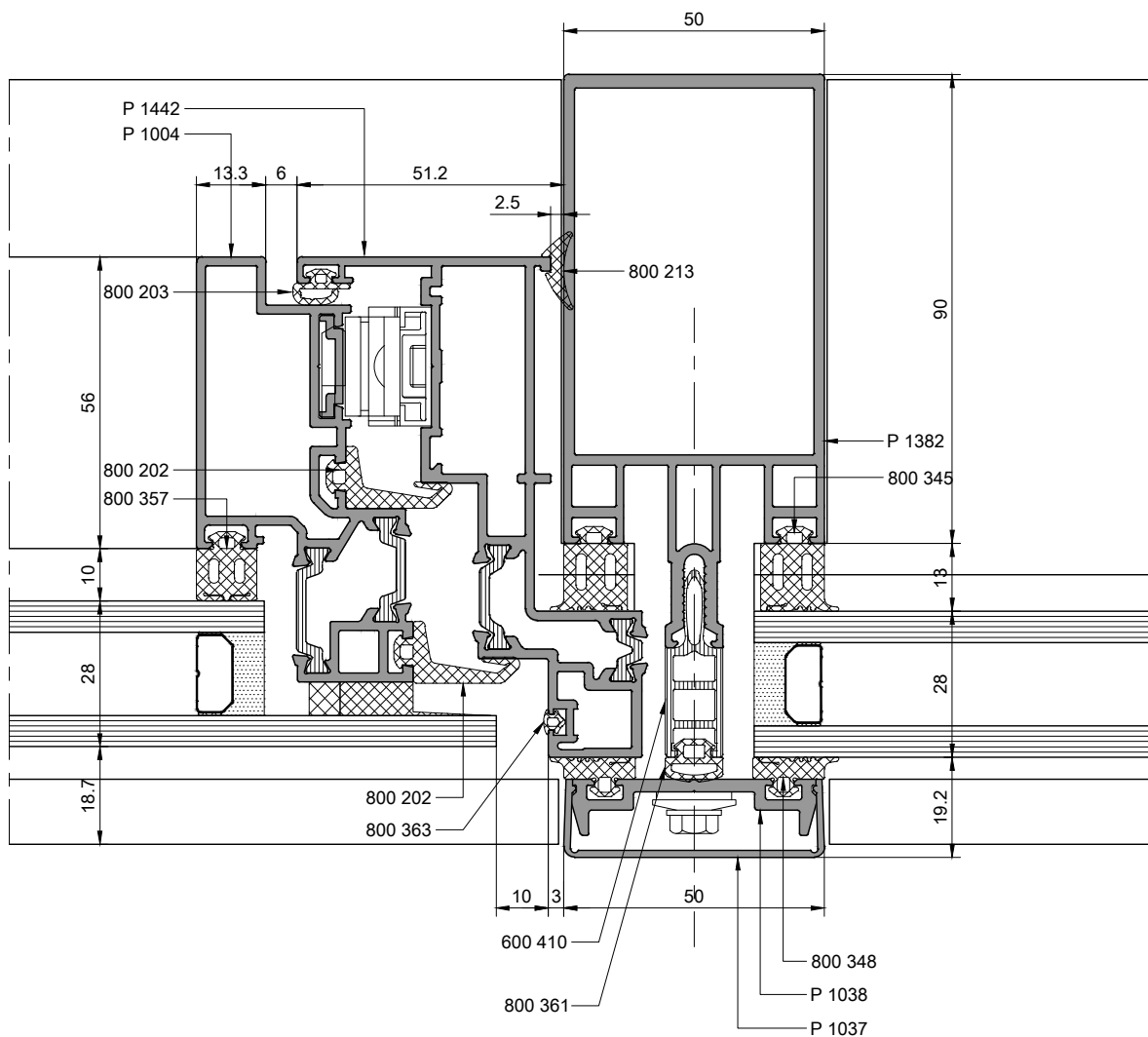
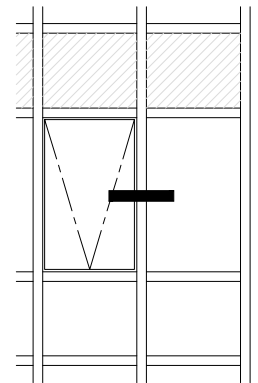

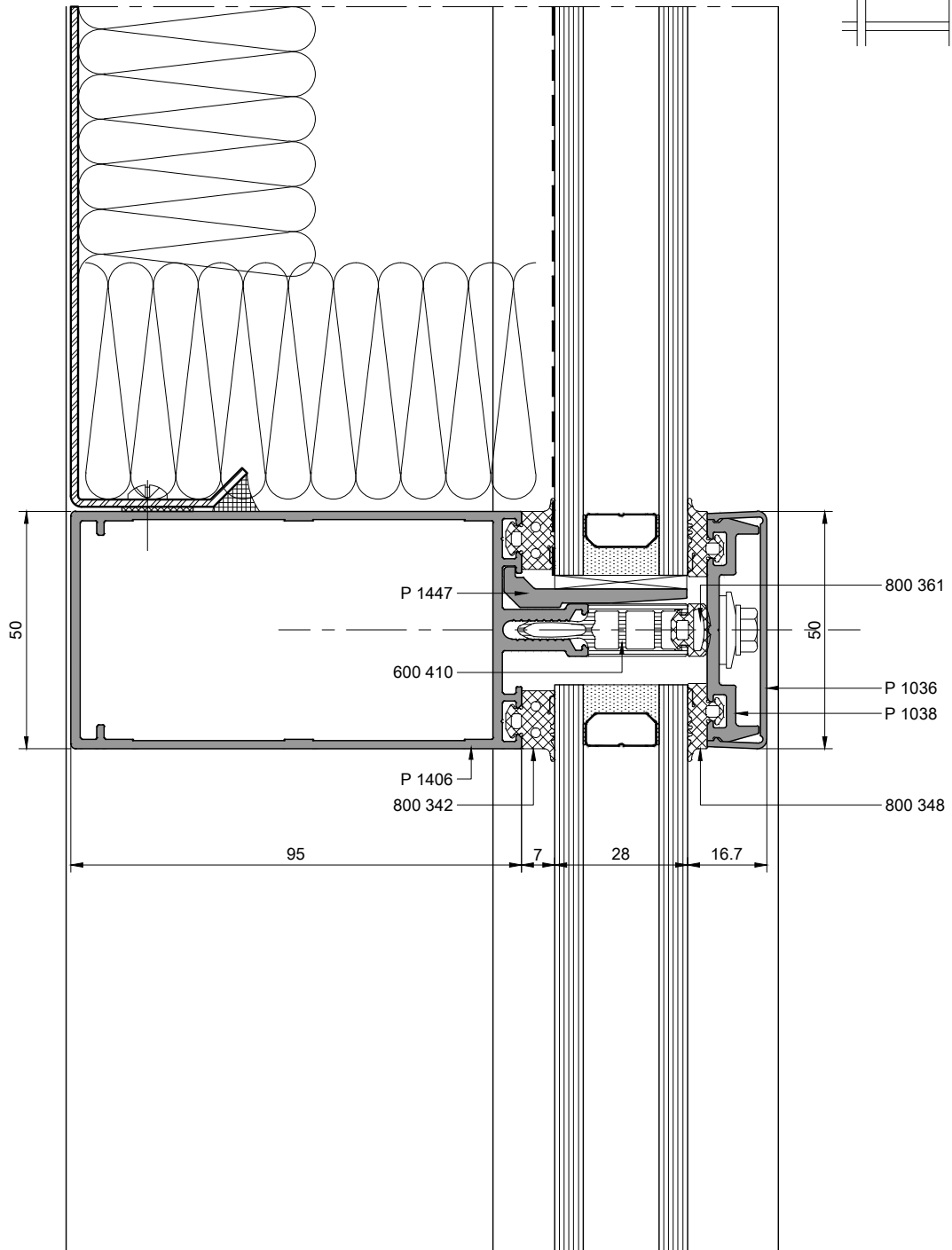
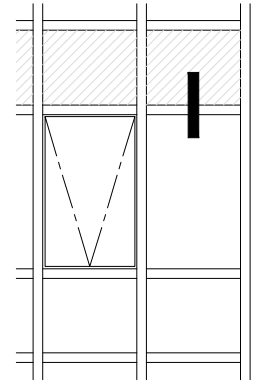

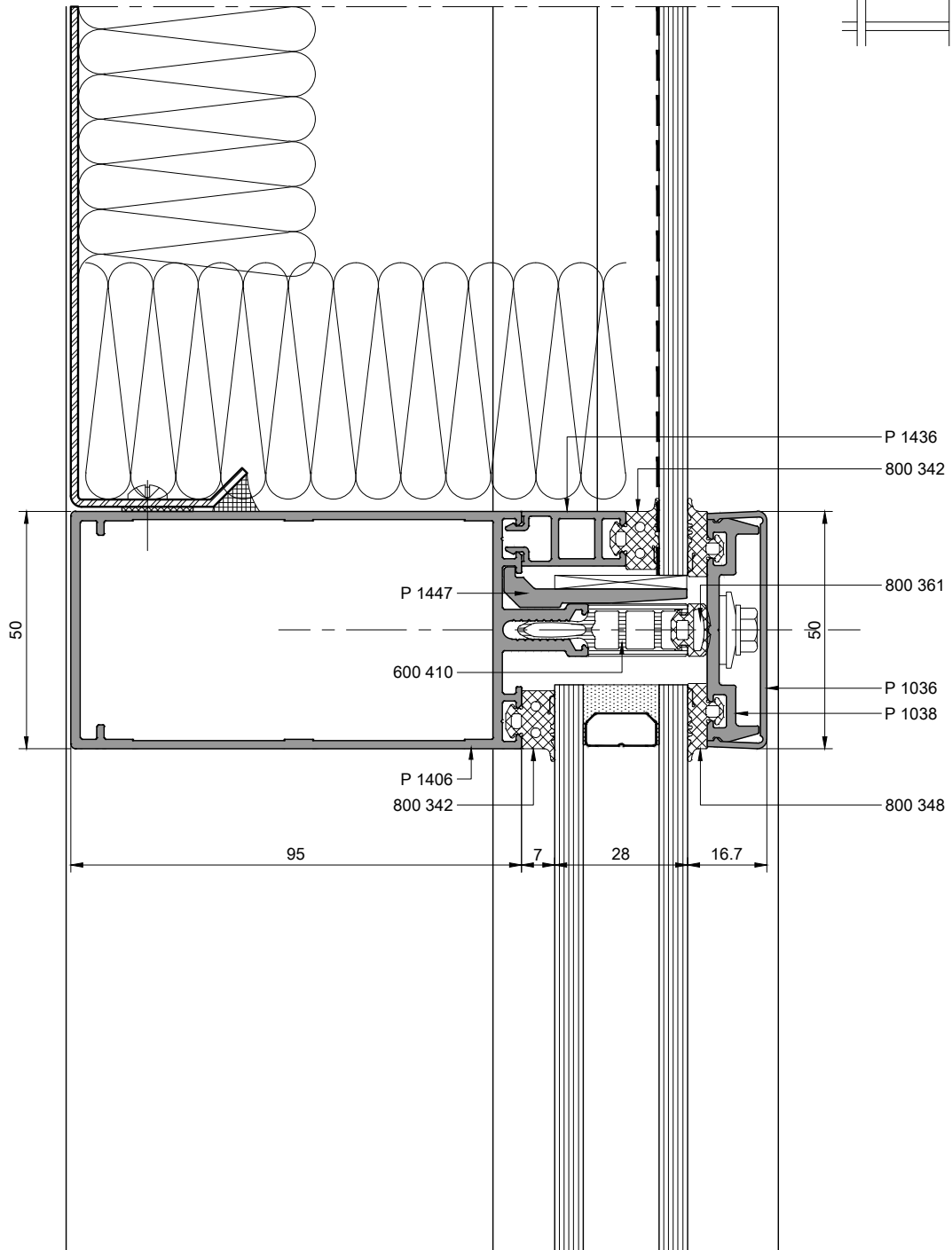
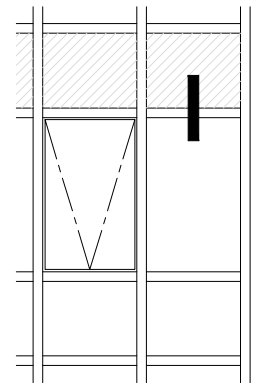

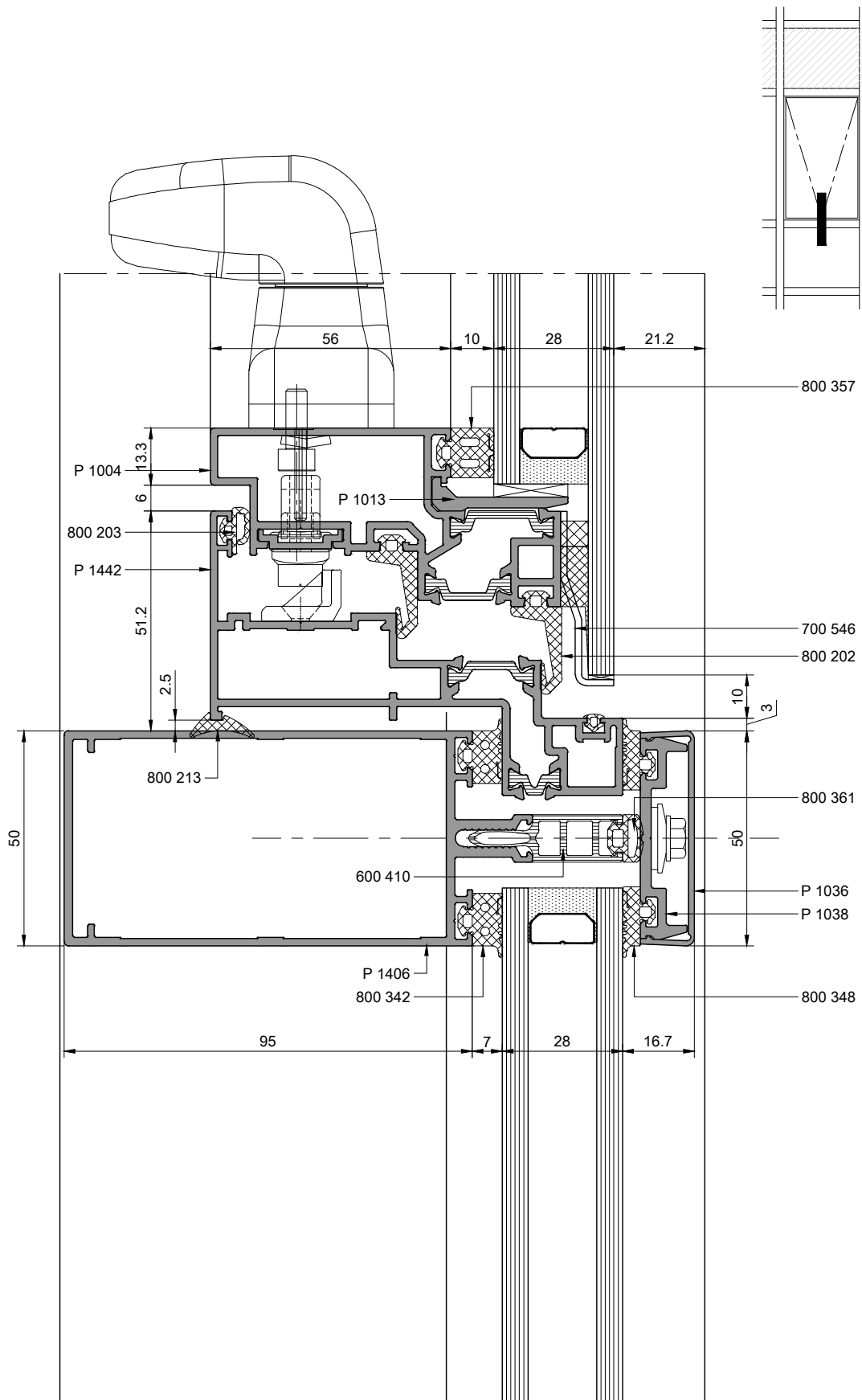

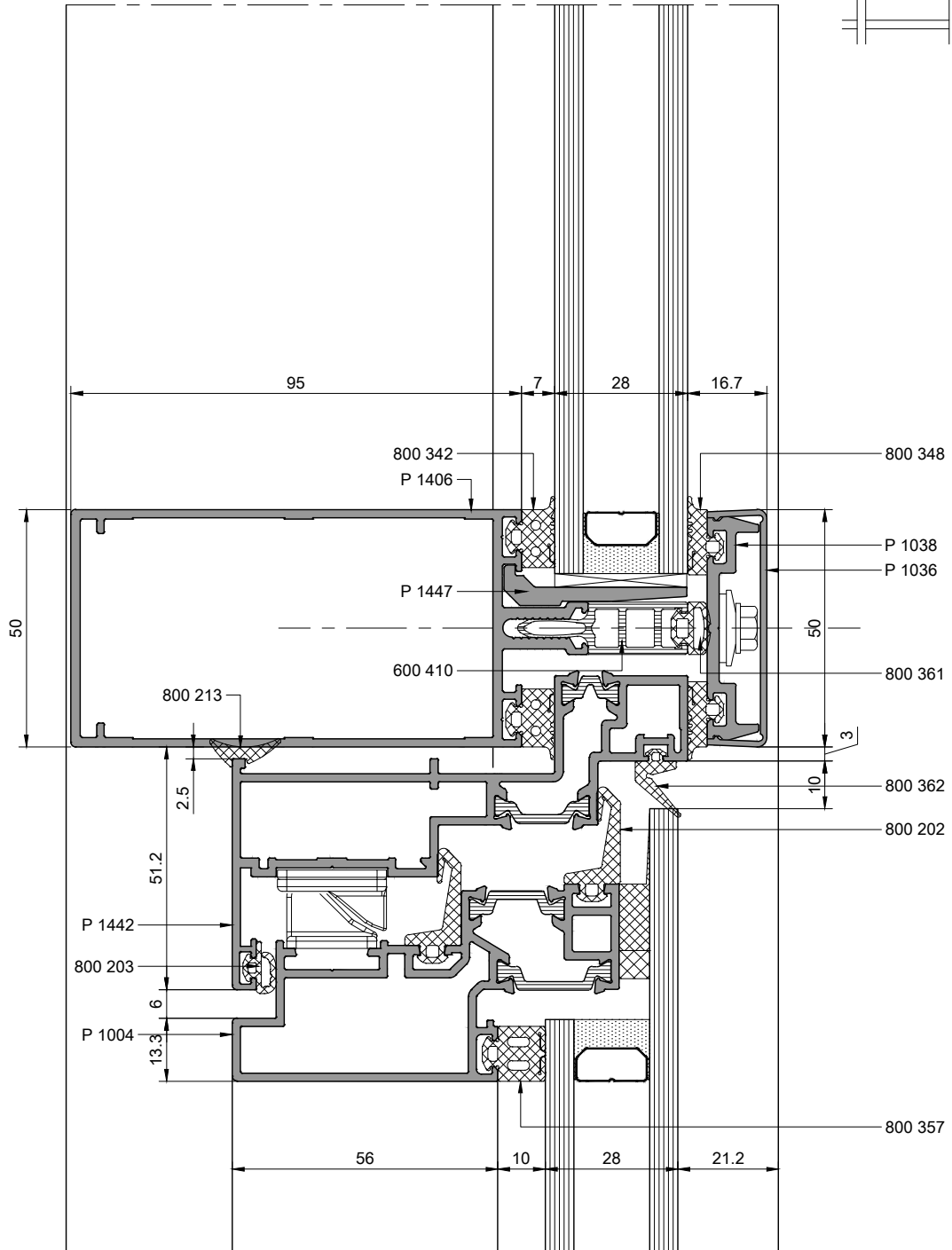
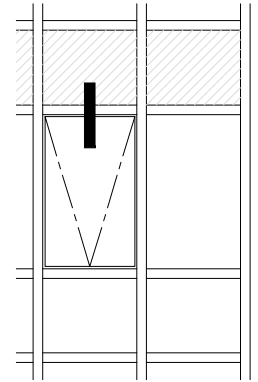

FS50
STICK GİYDİRME CEPHE SİSTEMİ
STICK CURTAIN WALL SYSTEM

SİLİKON CEPHE
SİSTEM DETAYLARI
(CAM İÇİ LOKAL U KANALLI)
SILICONE FACADE SYSTEM DETAILS
(INSIDE GLASS U CHANNEL)

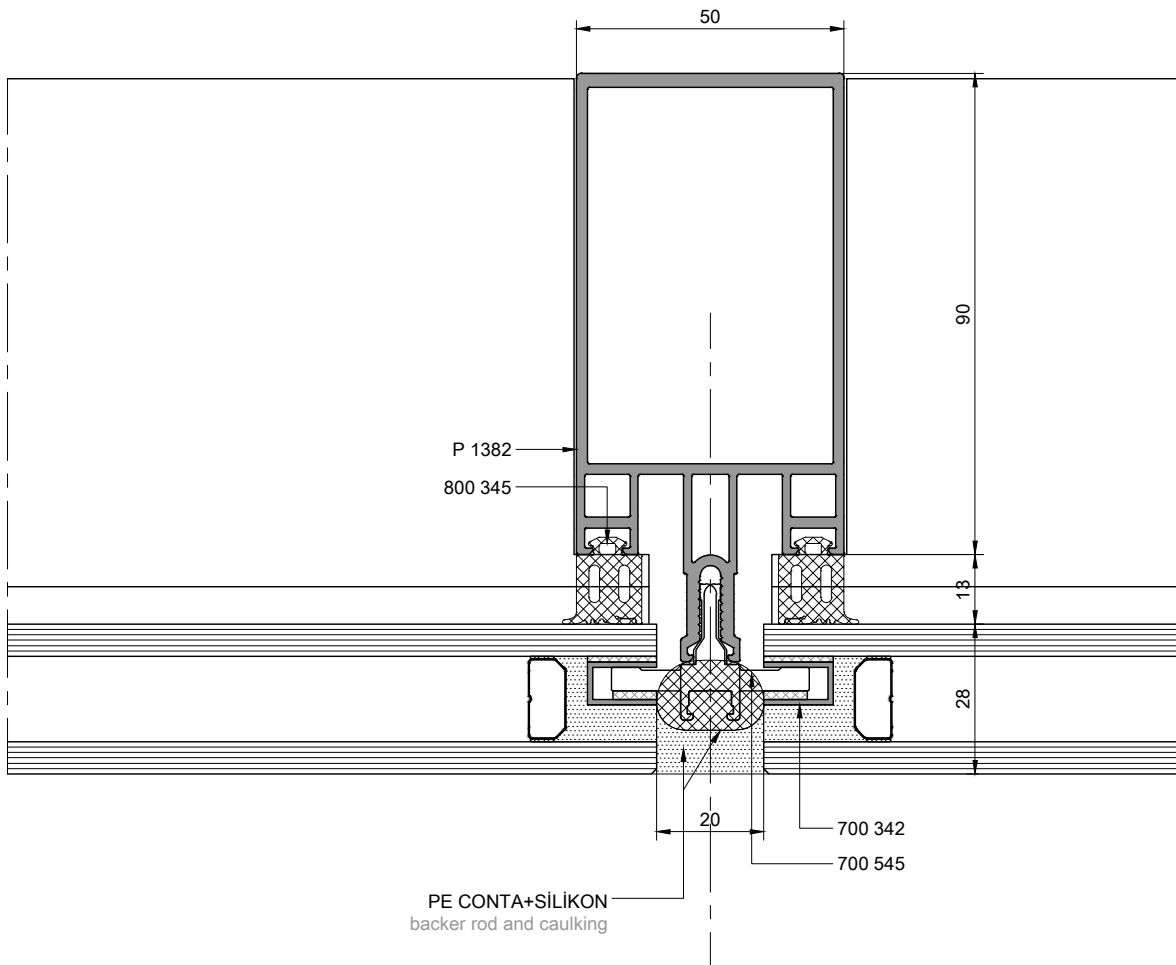
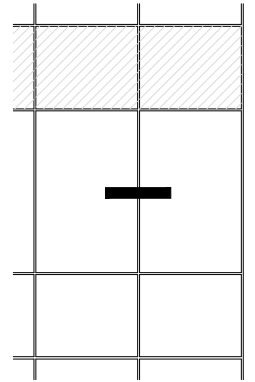

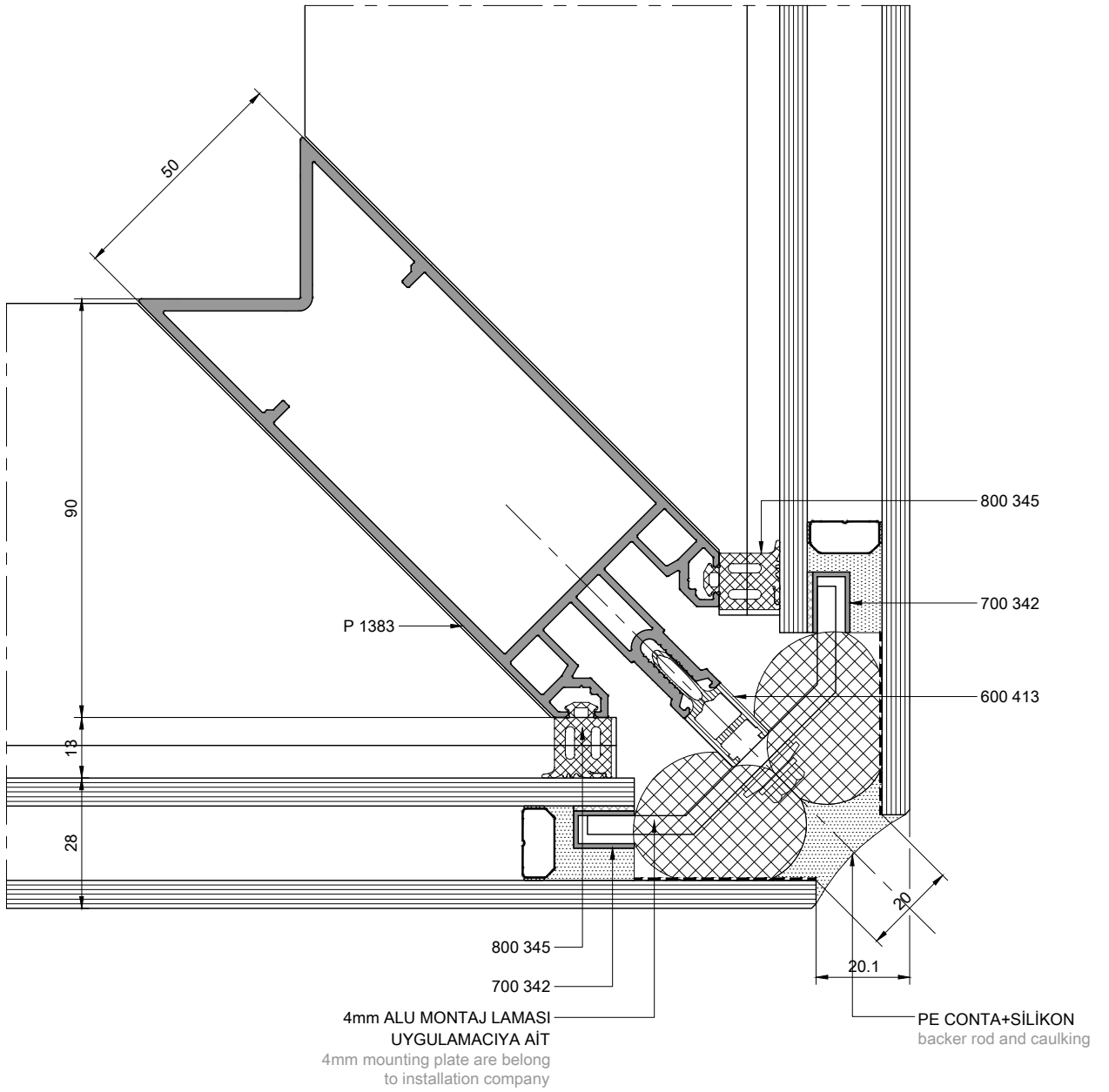
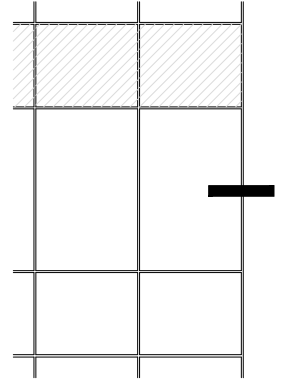

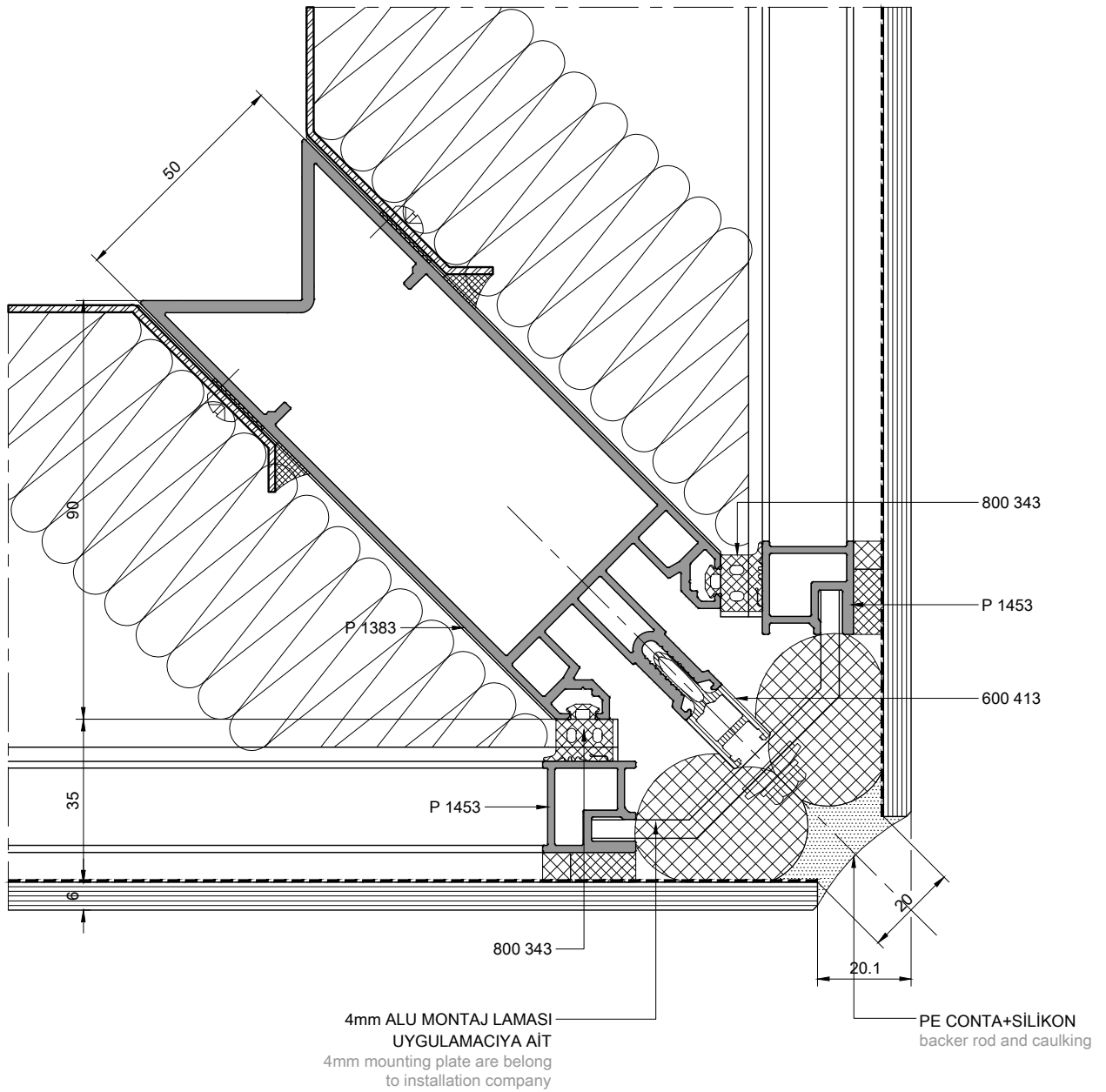
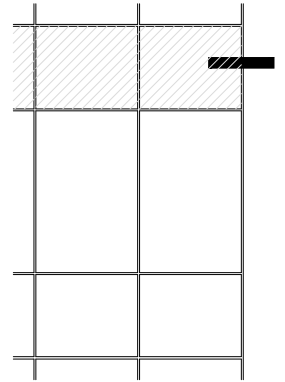

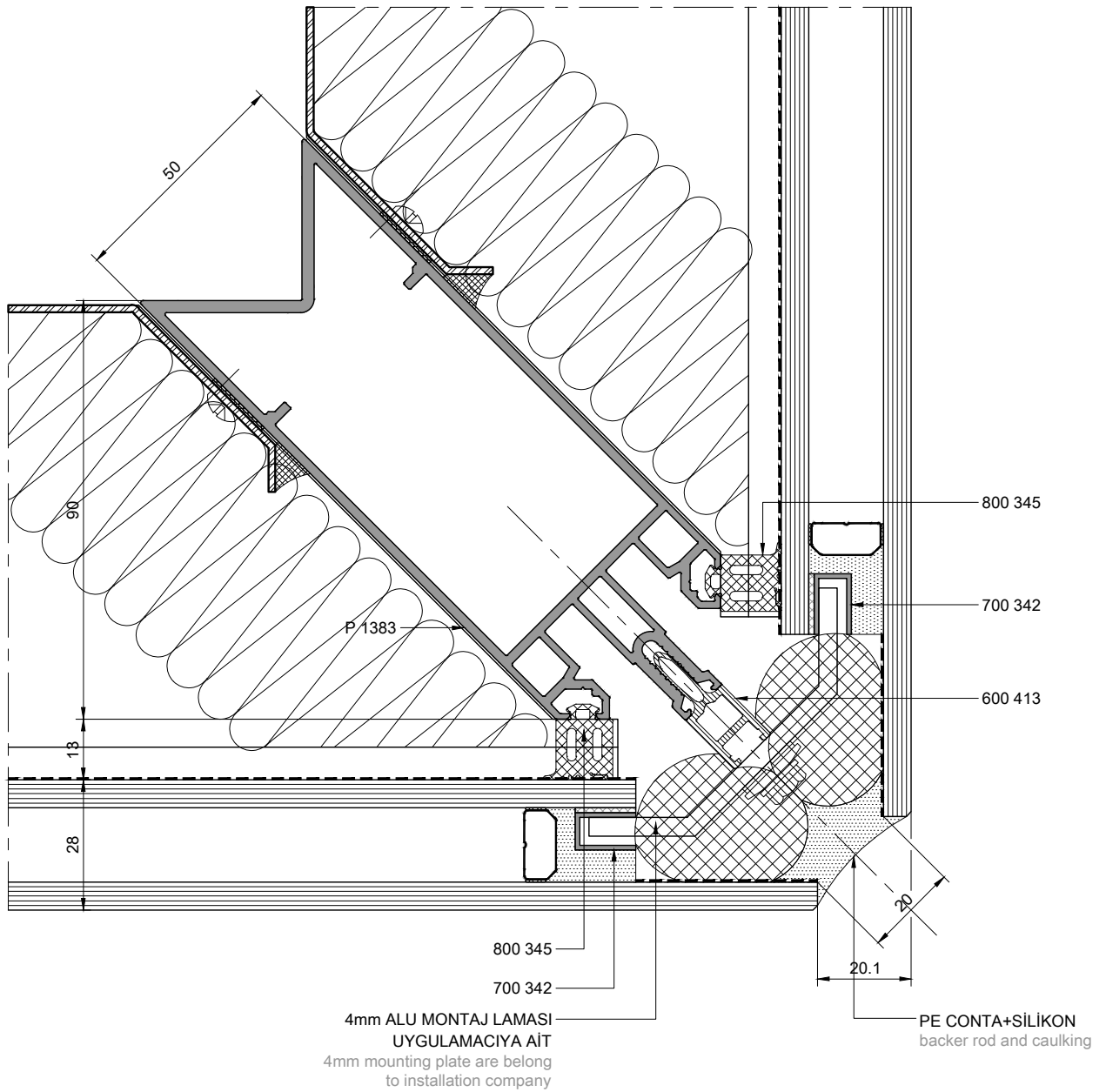
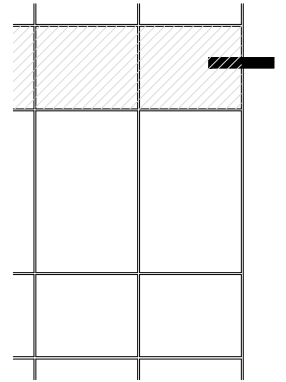

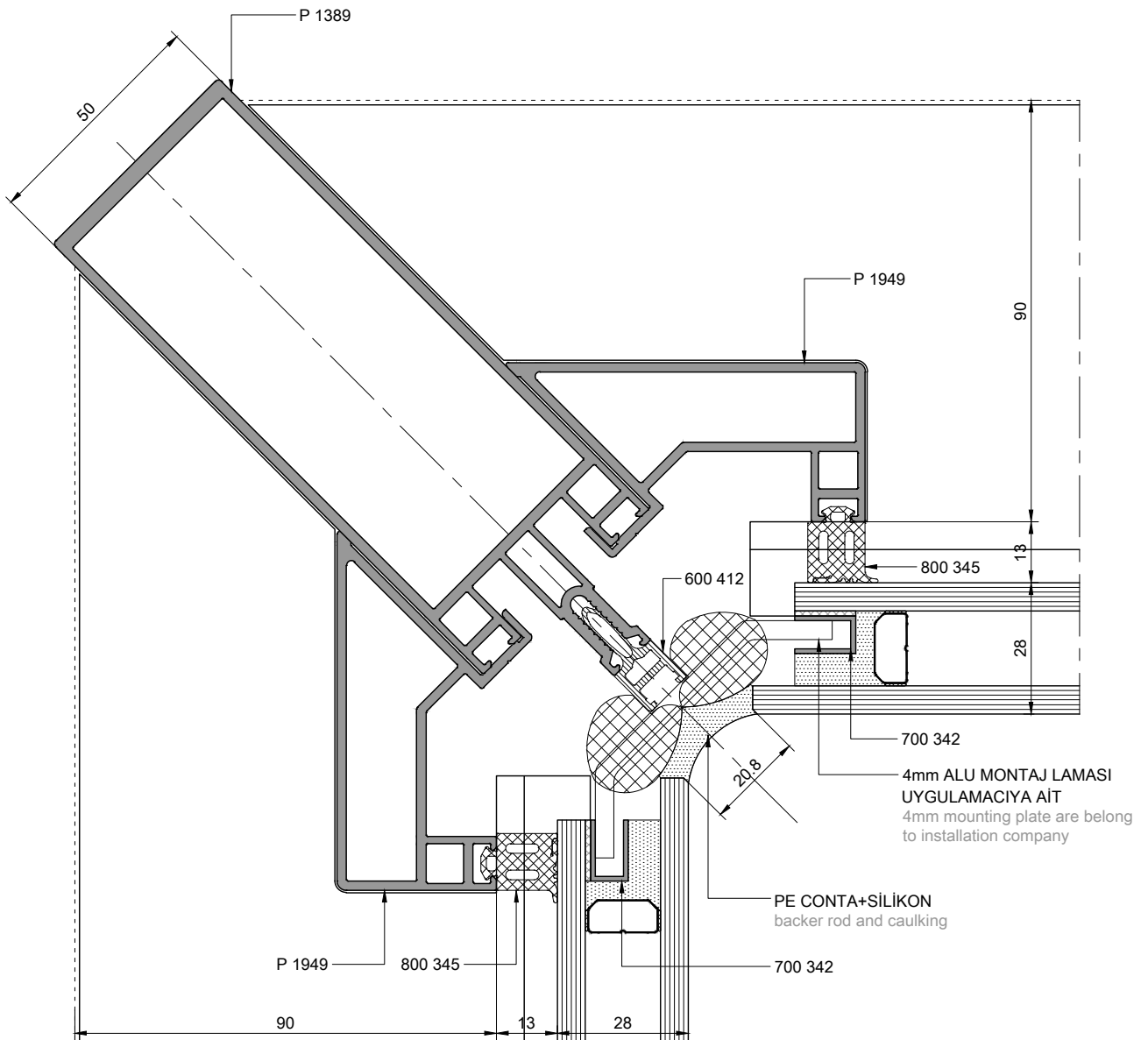
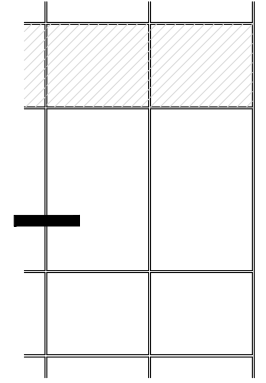

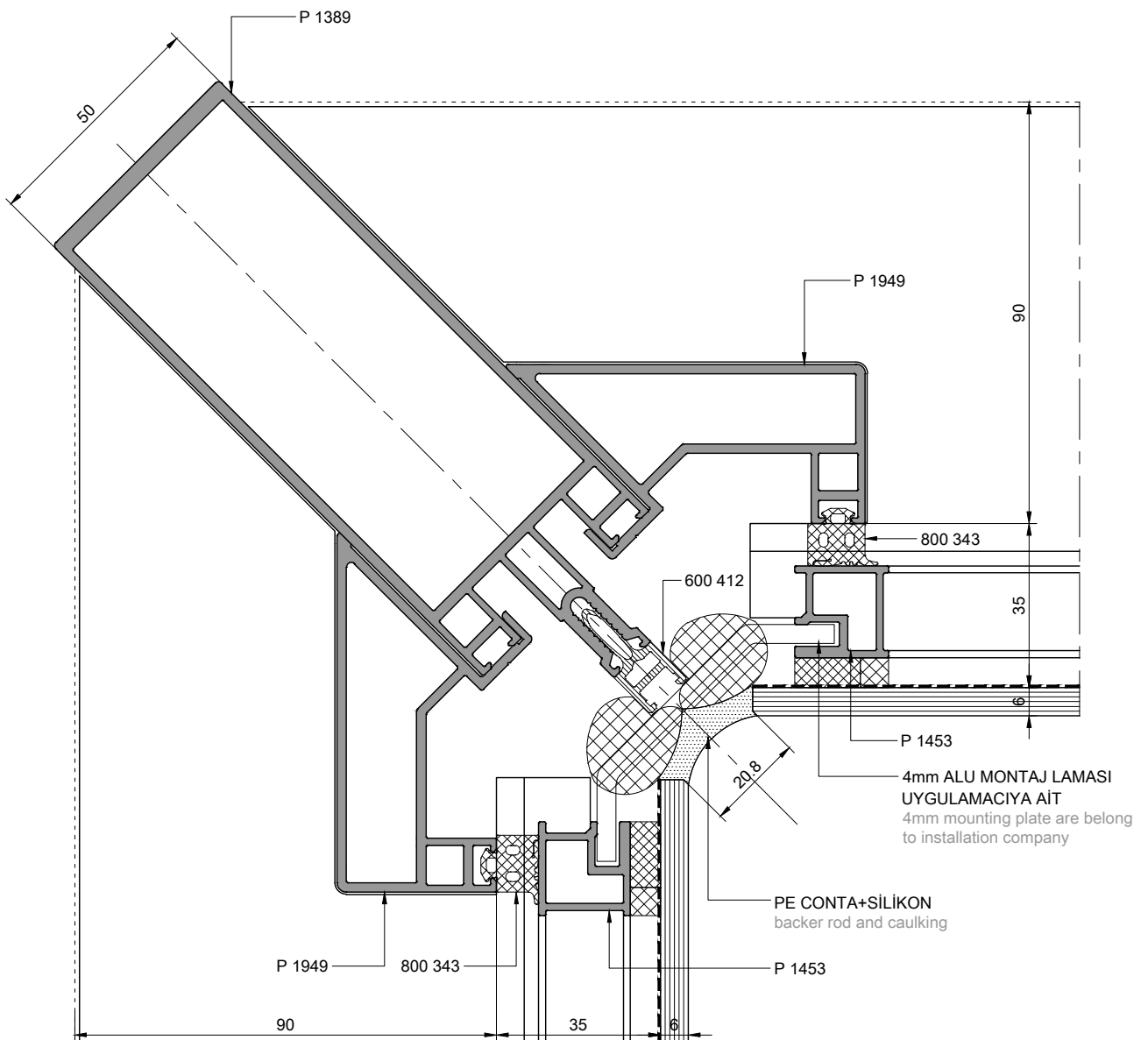
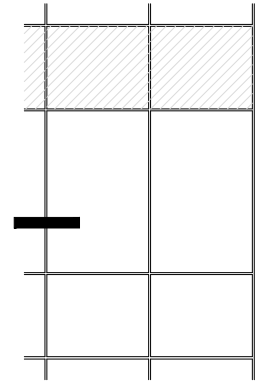

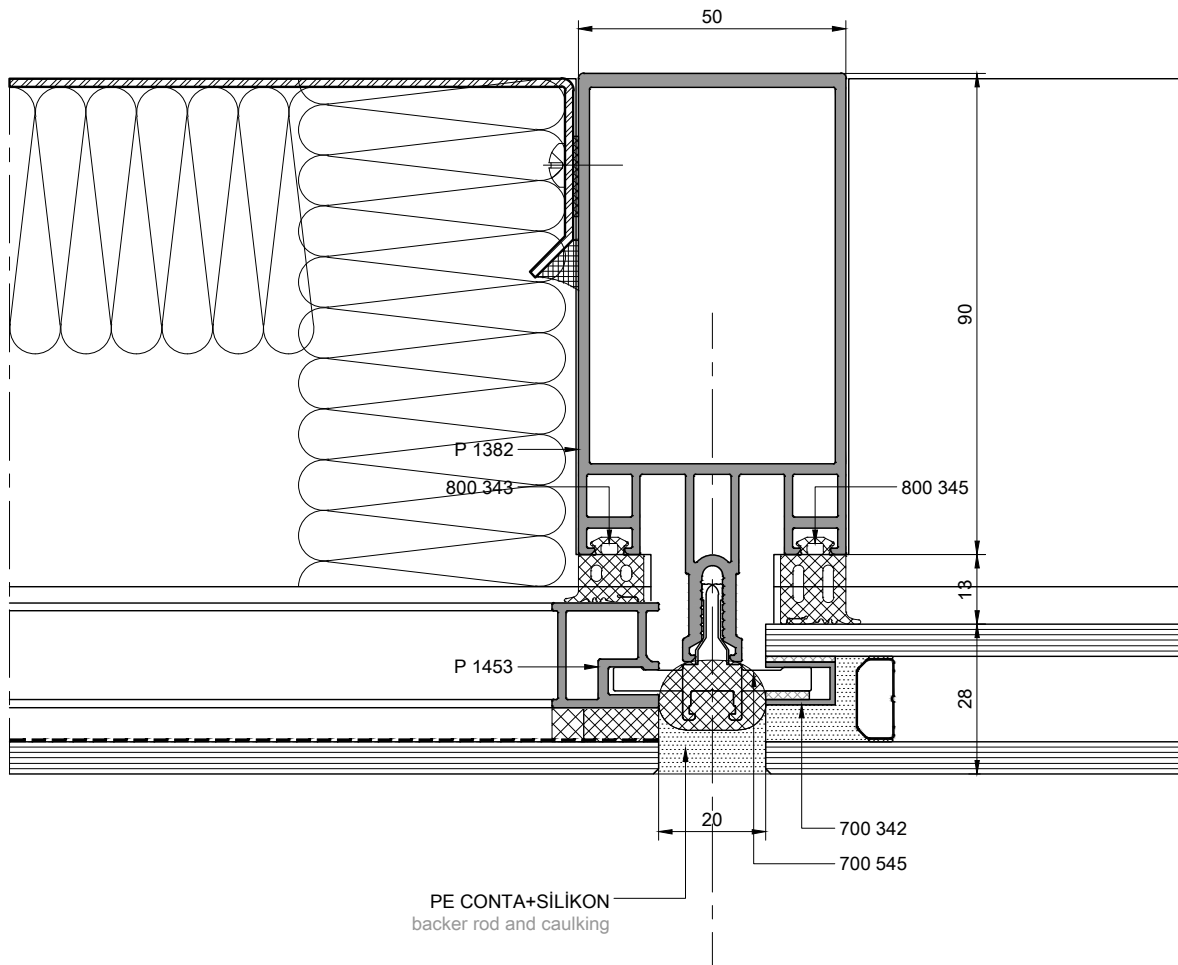
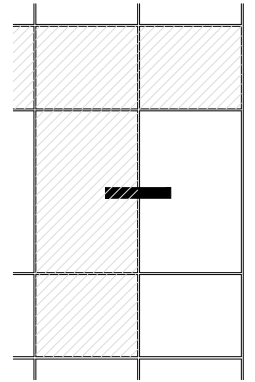

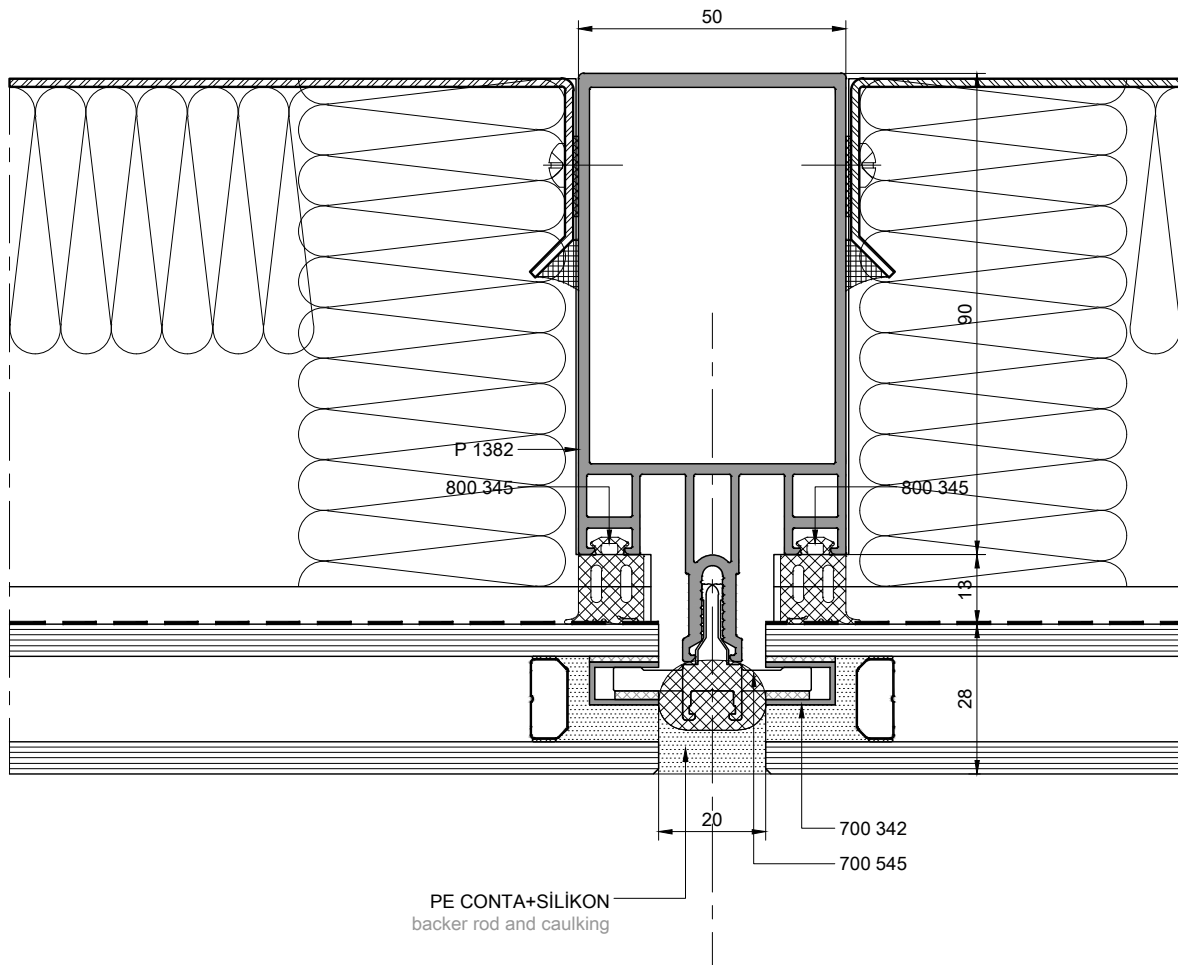
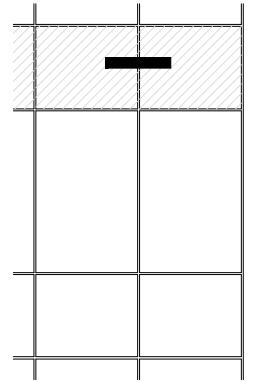

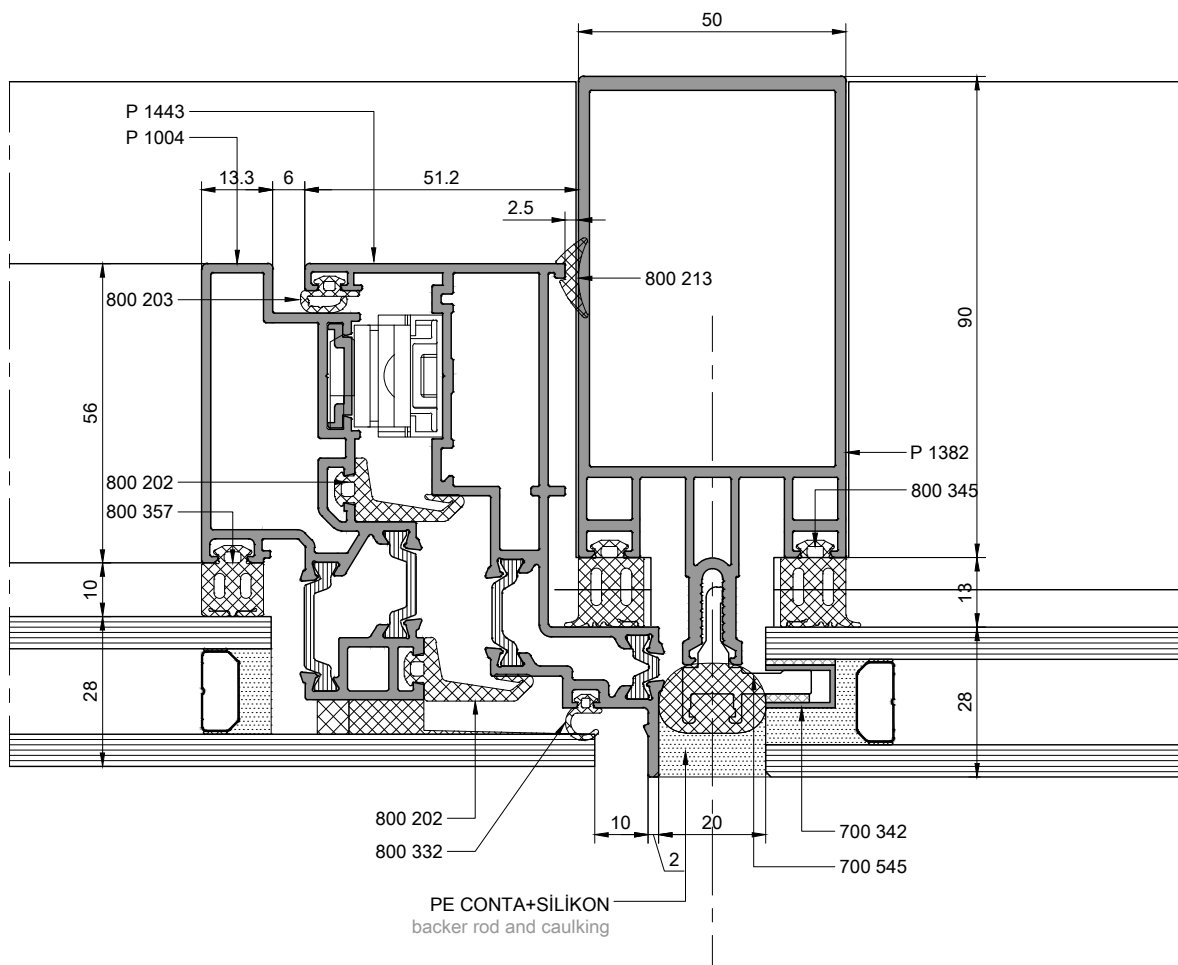
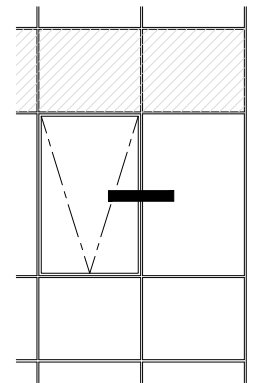

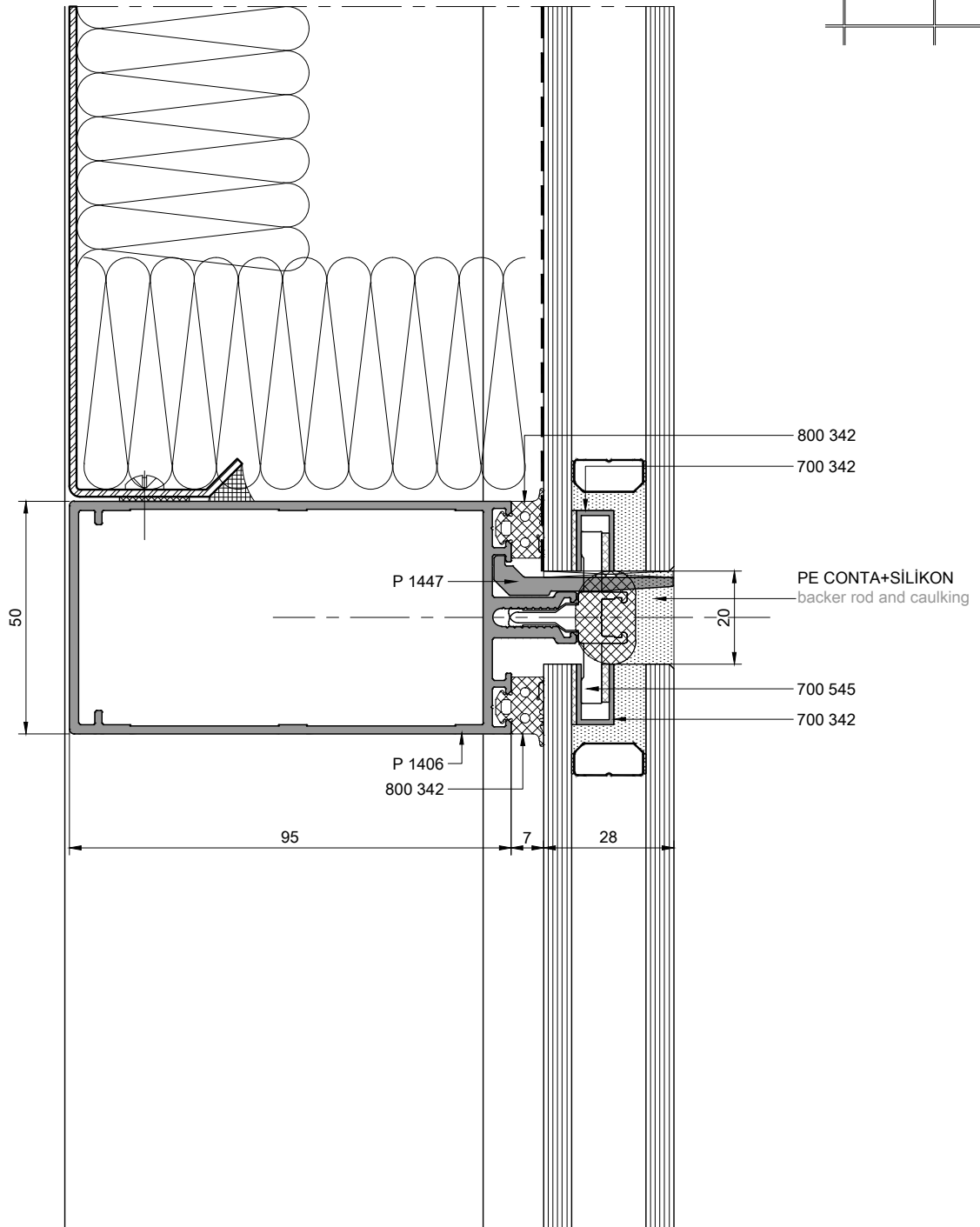
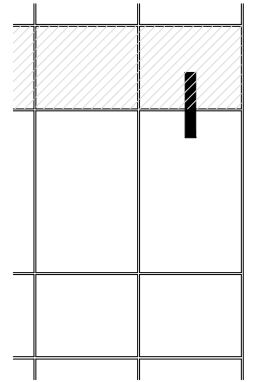

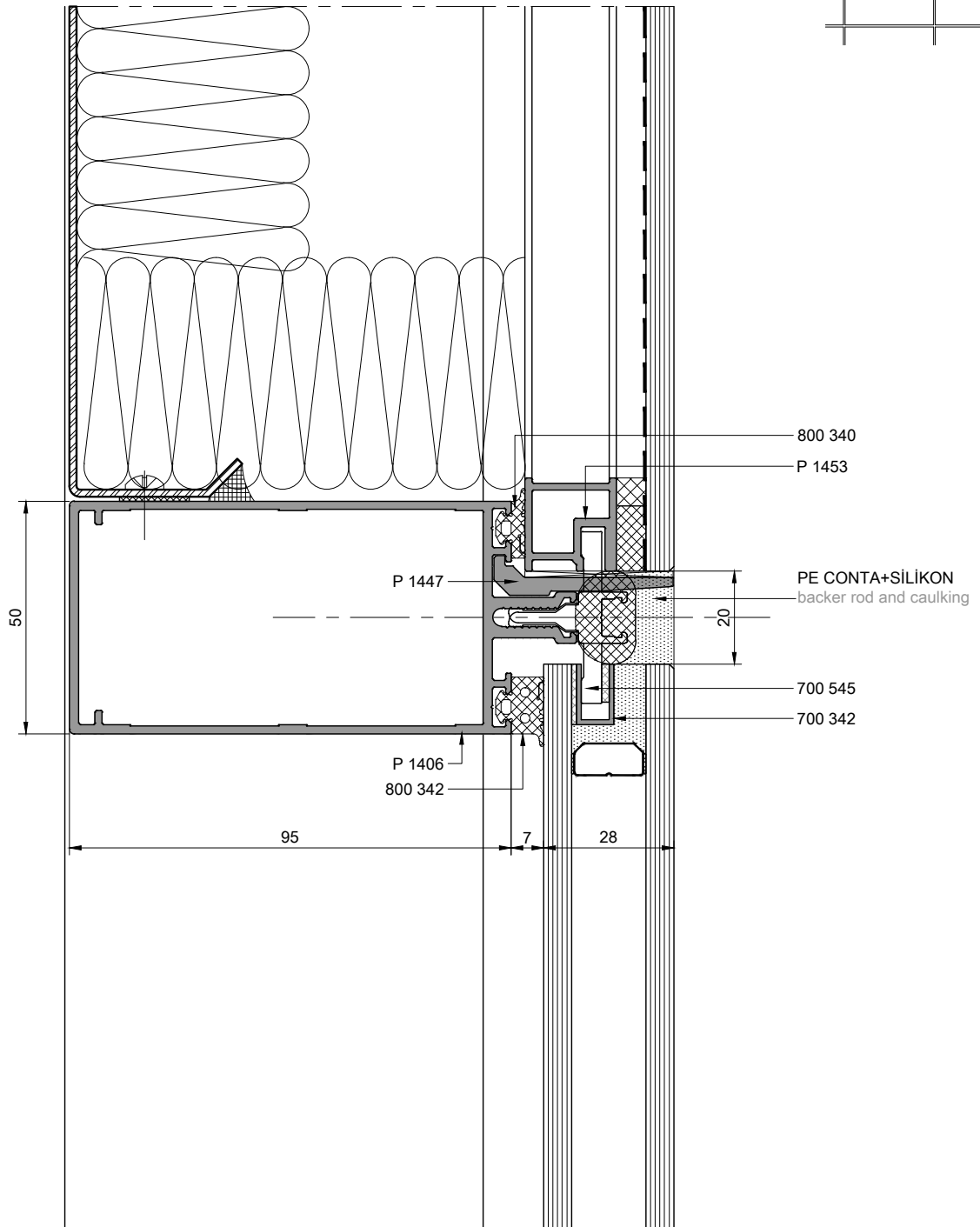
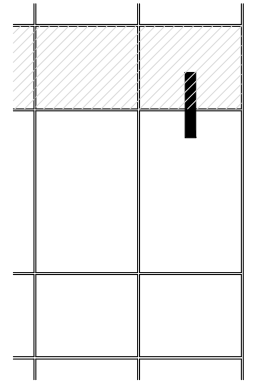

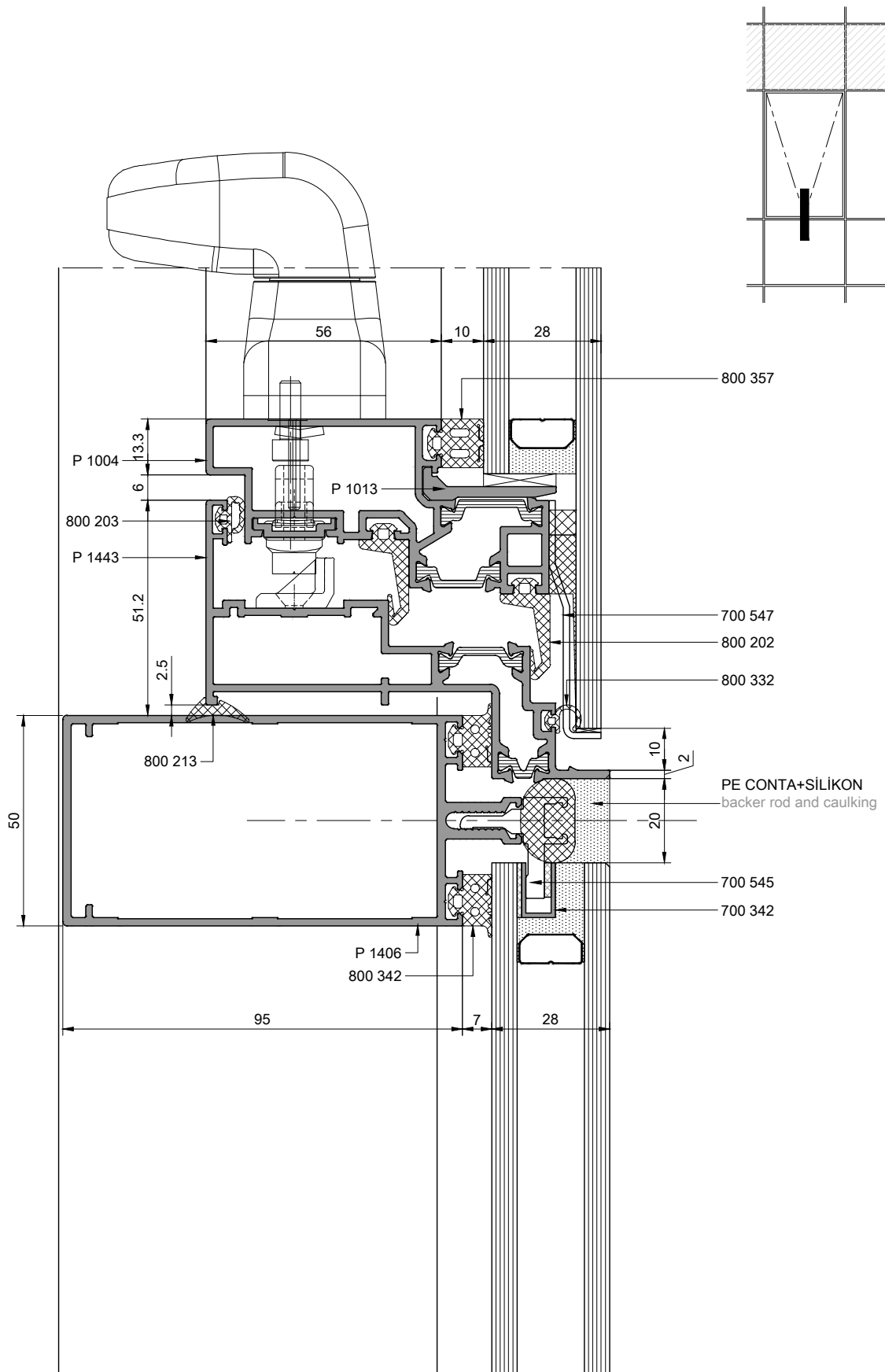

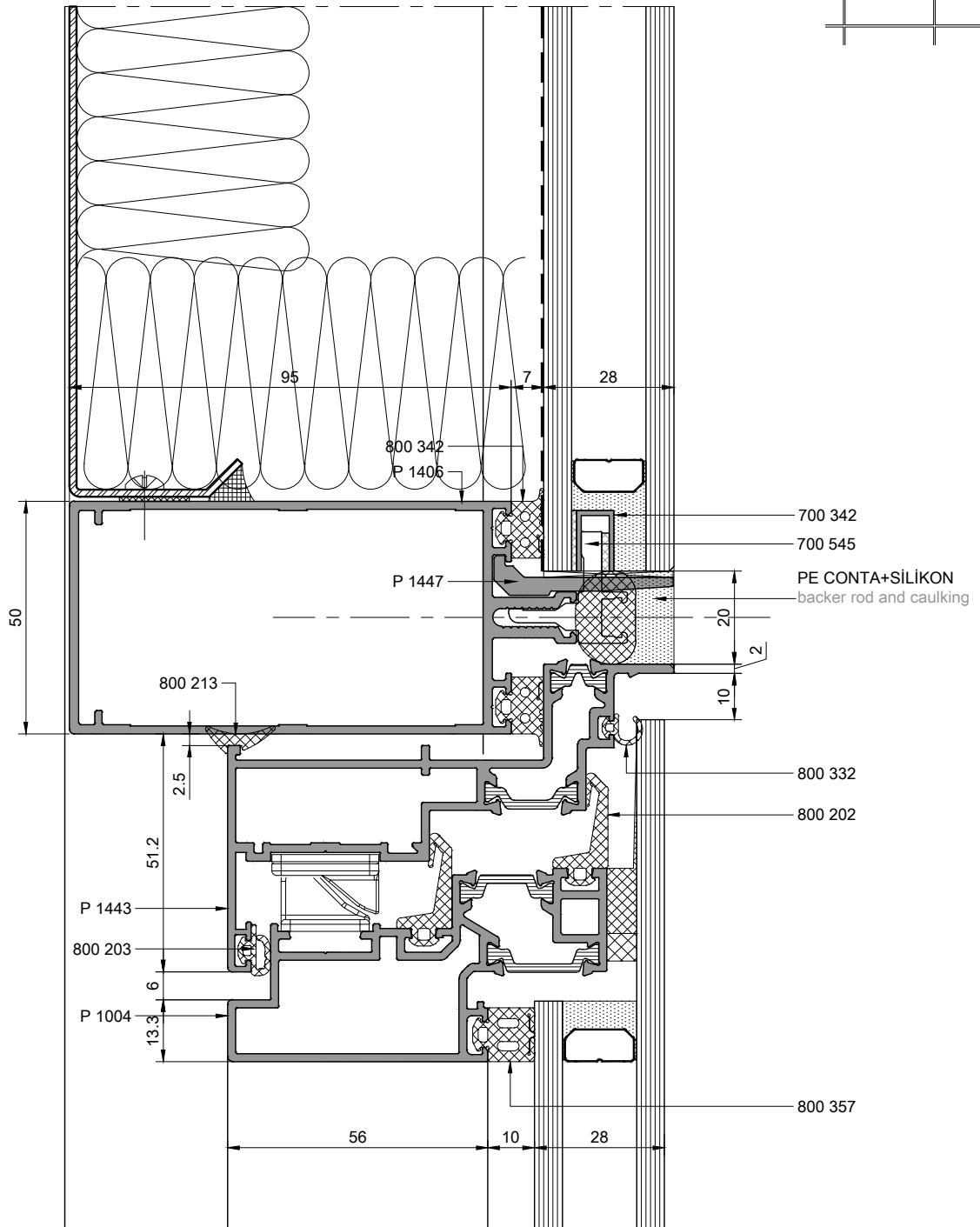
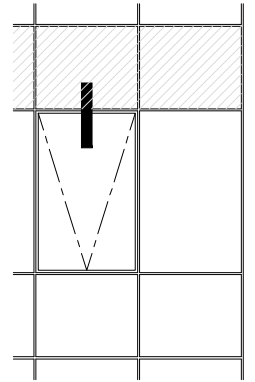

FS50
STICK GİYDİRME CEPHE SİSTEMİ
STICK CURTAIN WALL SYSTEM

DÜŞEY KAPAKLI SİLİKON CEPHE
SİSTEM DETAYLARI
(CAM İÇİ LOKAL U KANALLI)
VERTICAL CAPPED SILICONE FACADE
SYSTEM DETAILS
(INSIDE GLASS U CHANNEL)

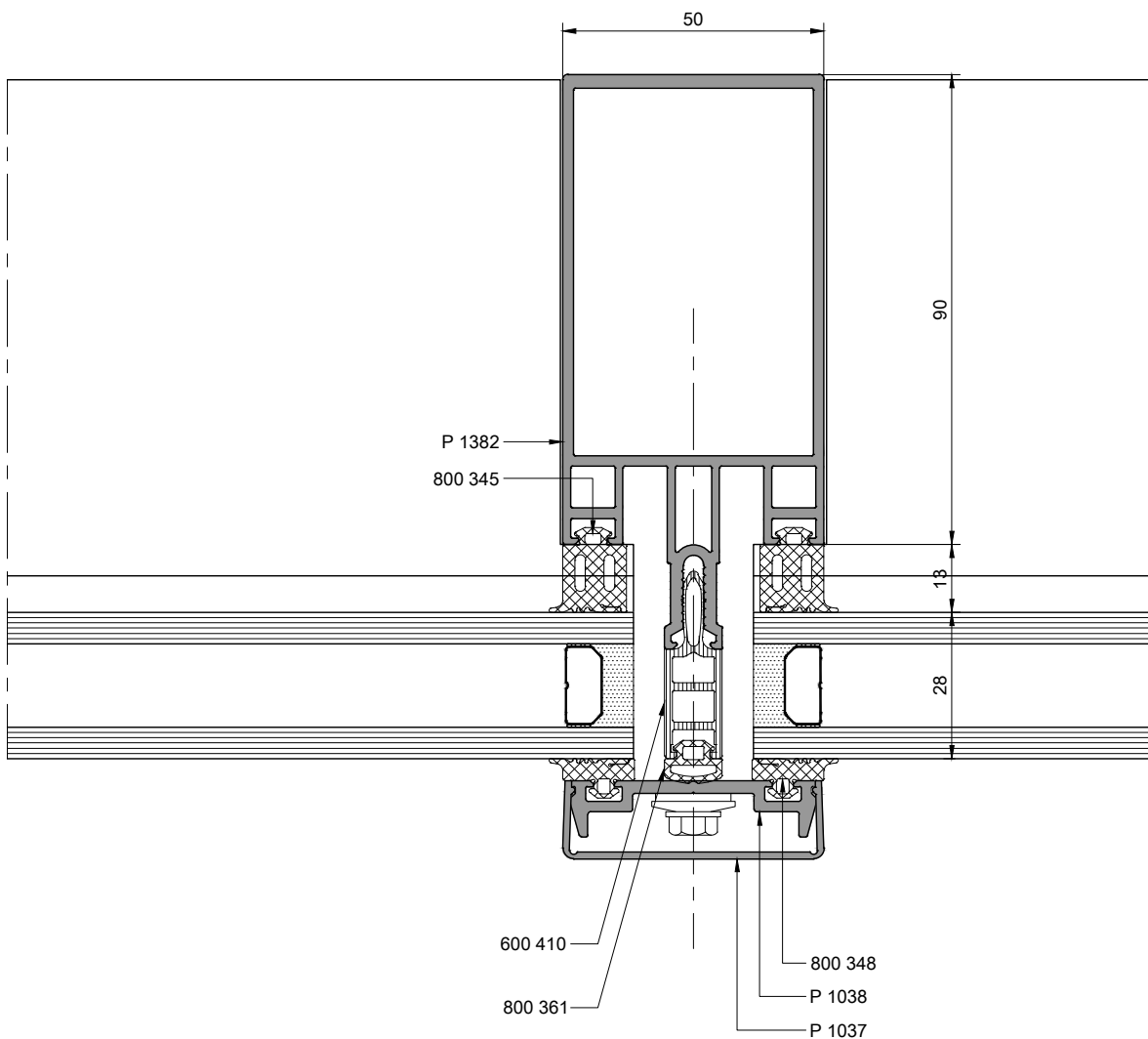
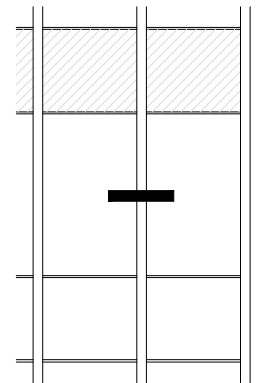

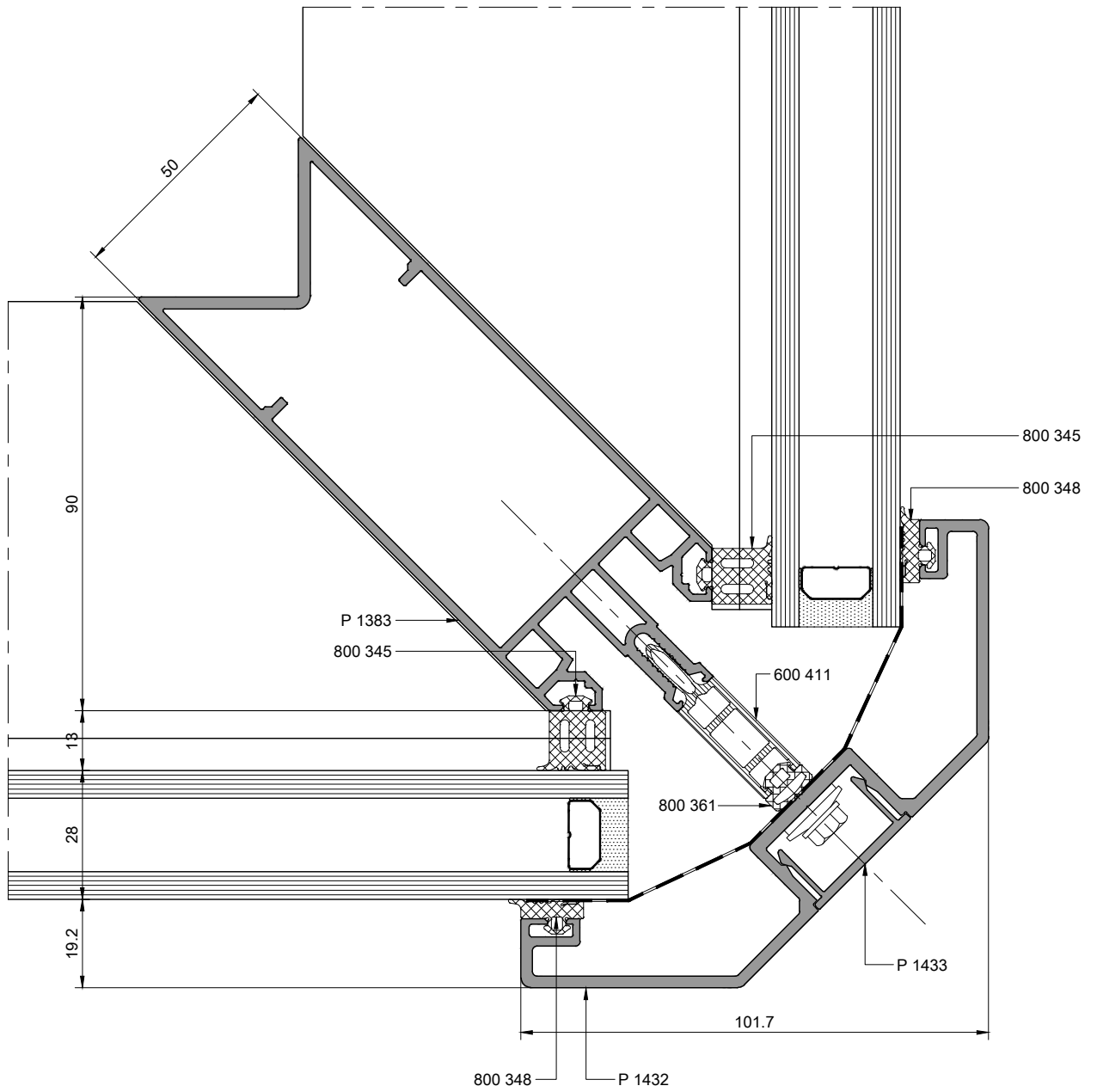
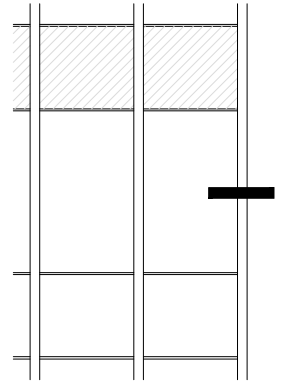

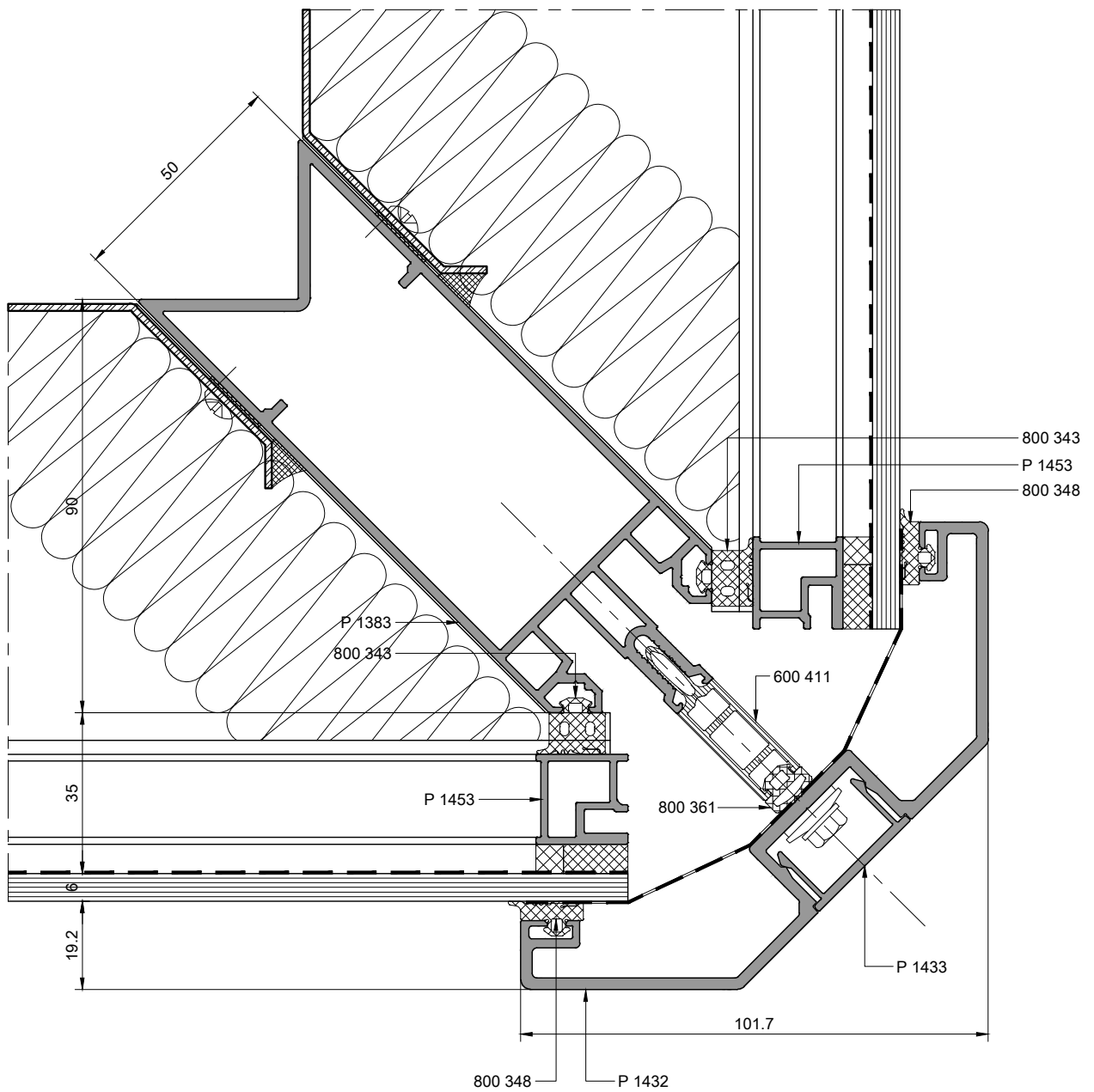
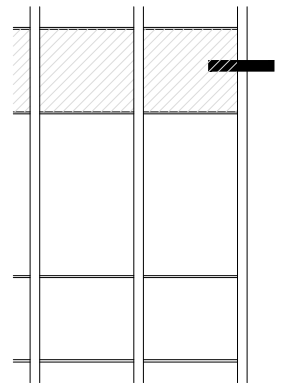

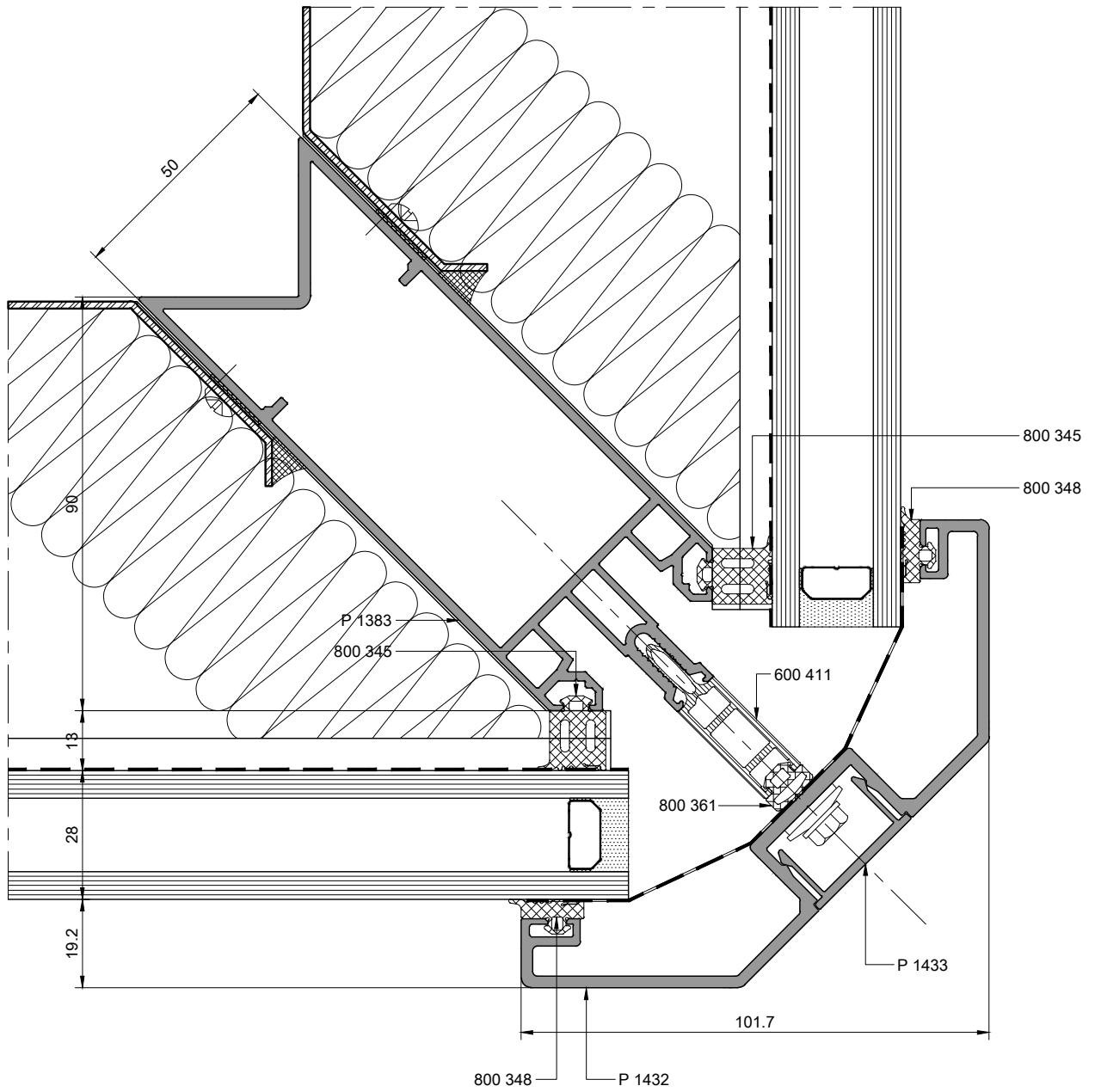
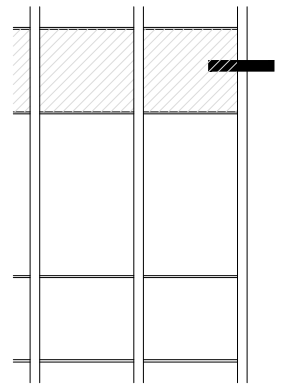

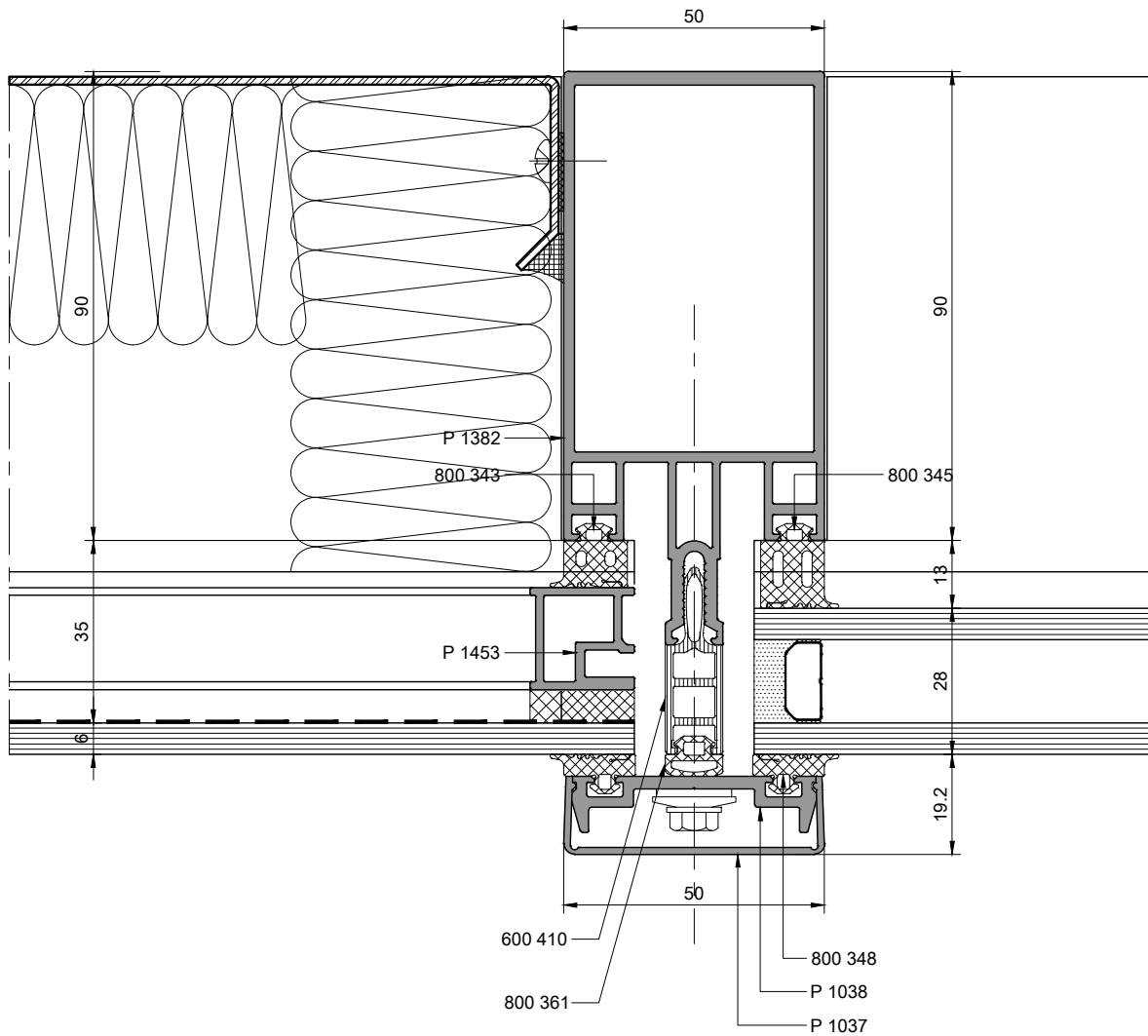
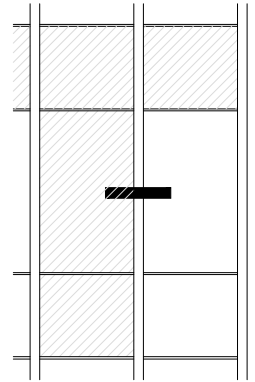

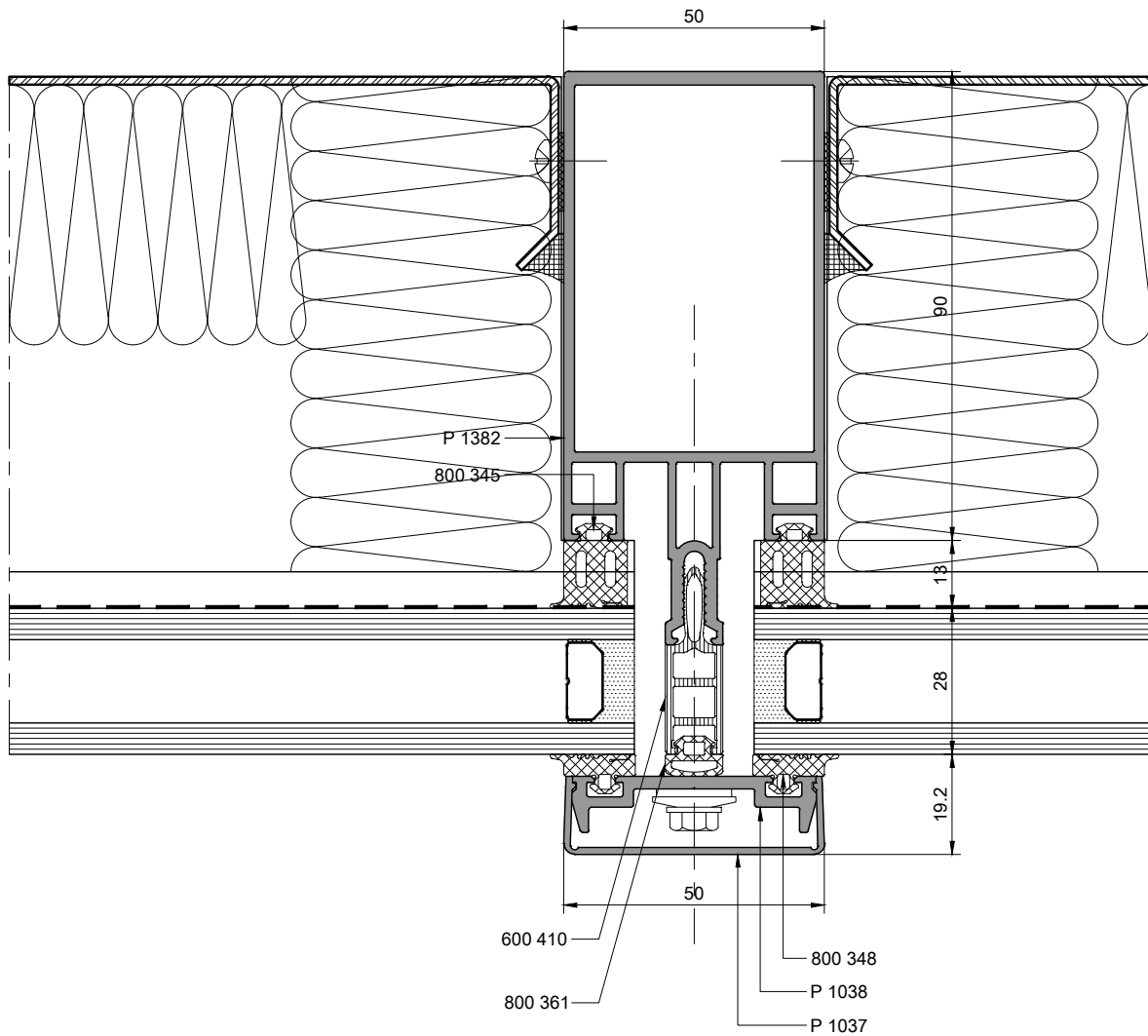
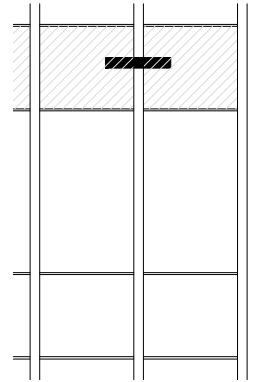

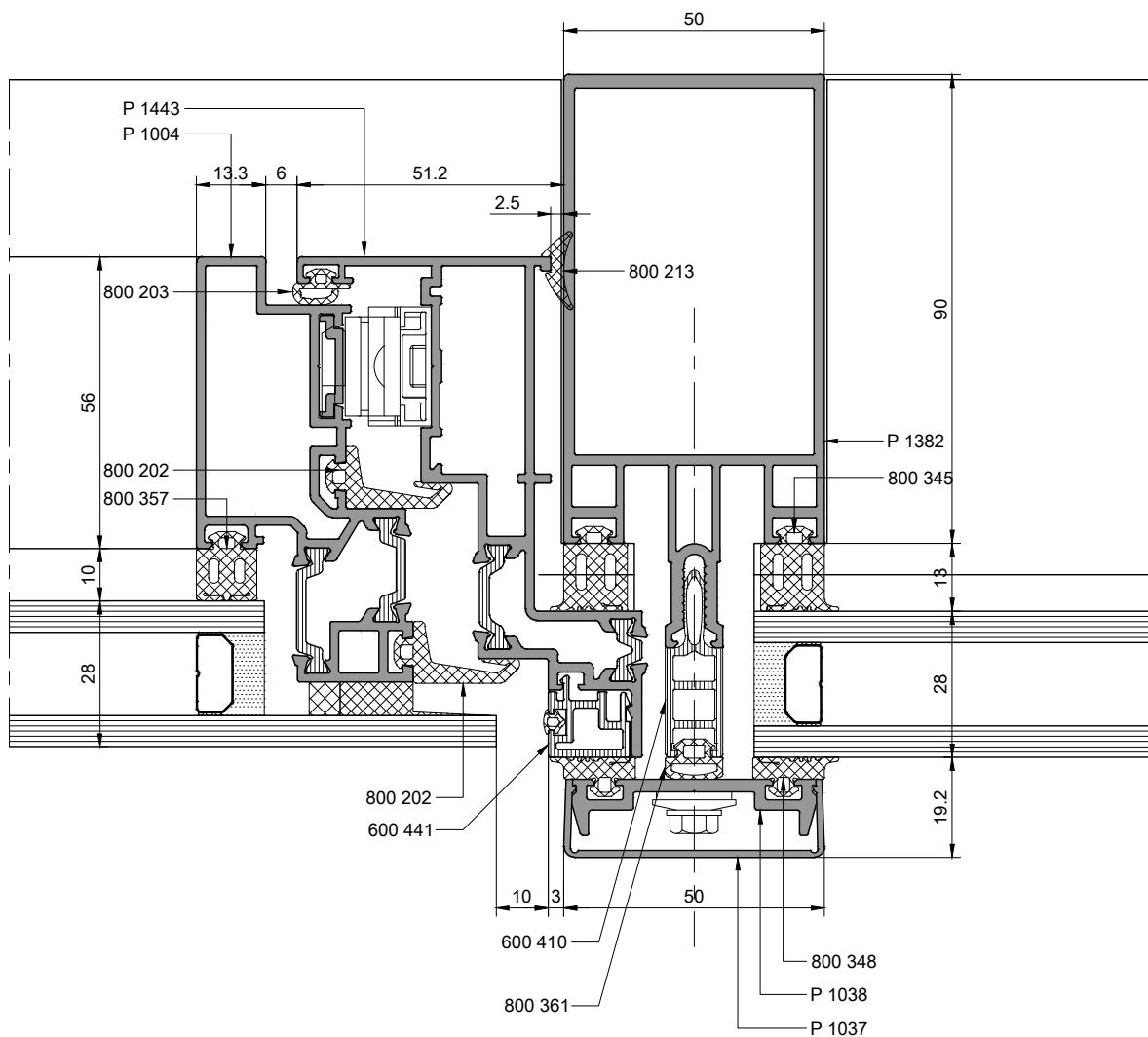
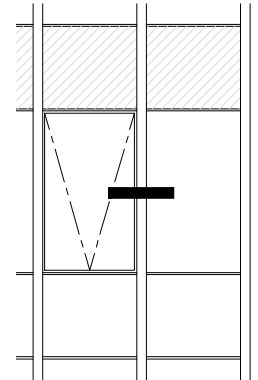

FS50
STICK GİYDİRME CEPHE SİSTEMİ
STICK CURTAIN WALL SYSTEM

YATAY KAPAKLI SİLİKON CEPHE
SİSTEM DETAYLARI
(CAM İÇİ LOKAL U KANALLI)
HORIZONTAL CAPPED SILICONE FACADE
SYSTEM DETAILS
(INSIDE GLASS U CHANNEL)

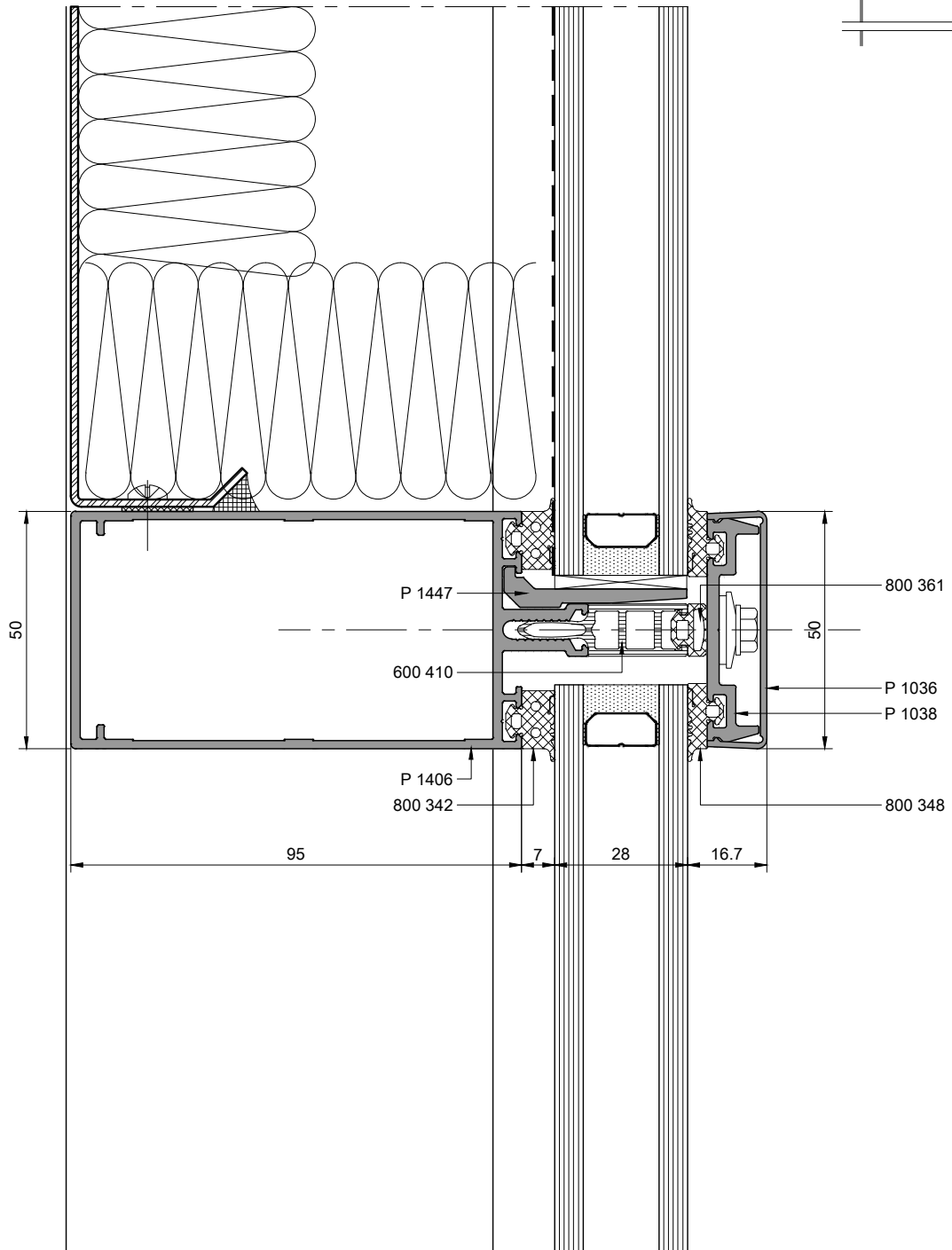
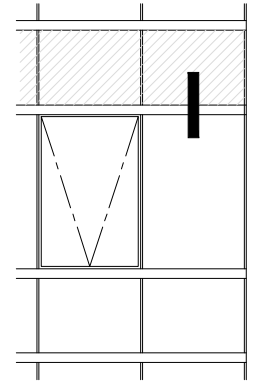

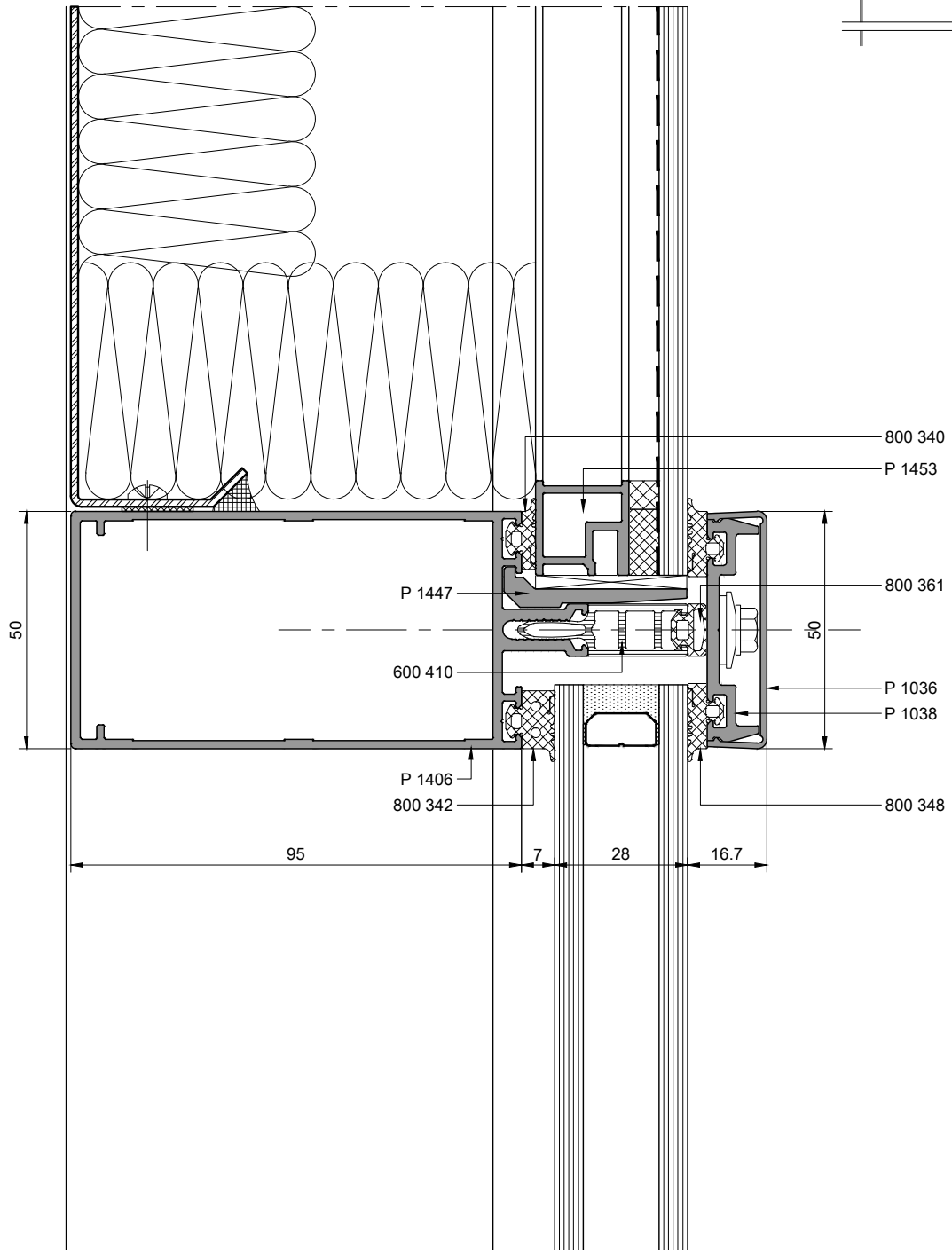
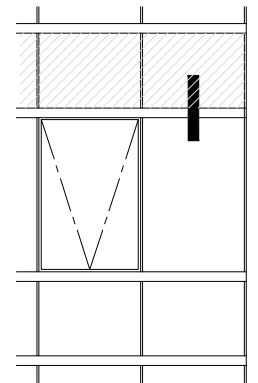

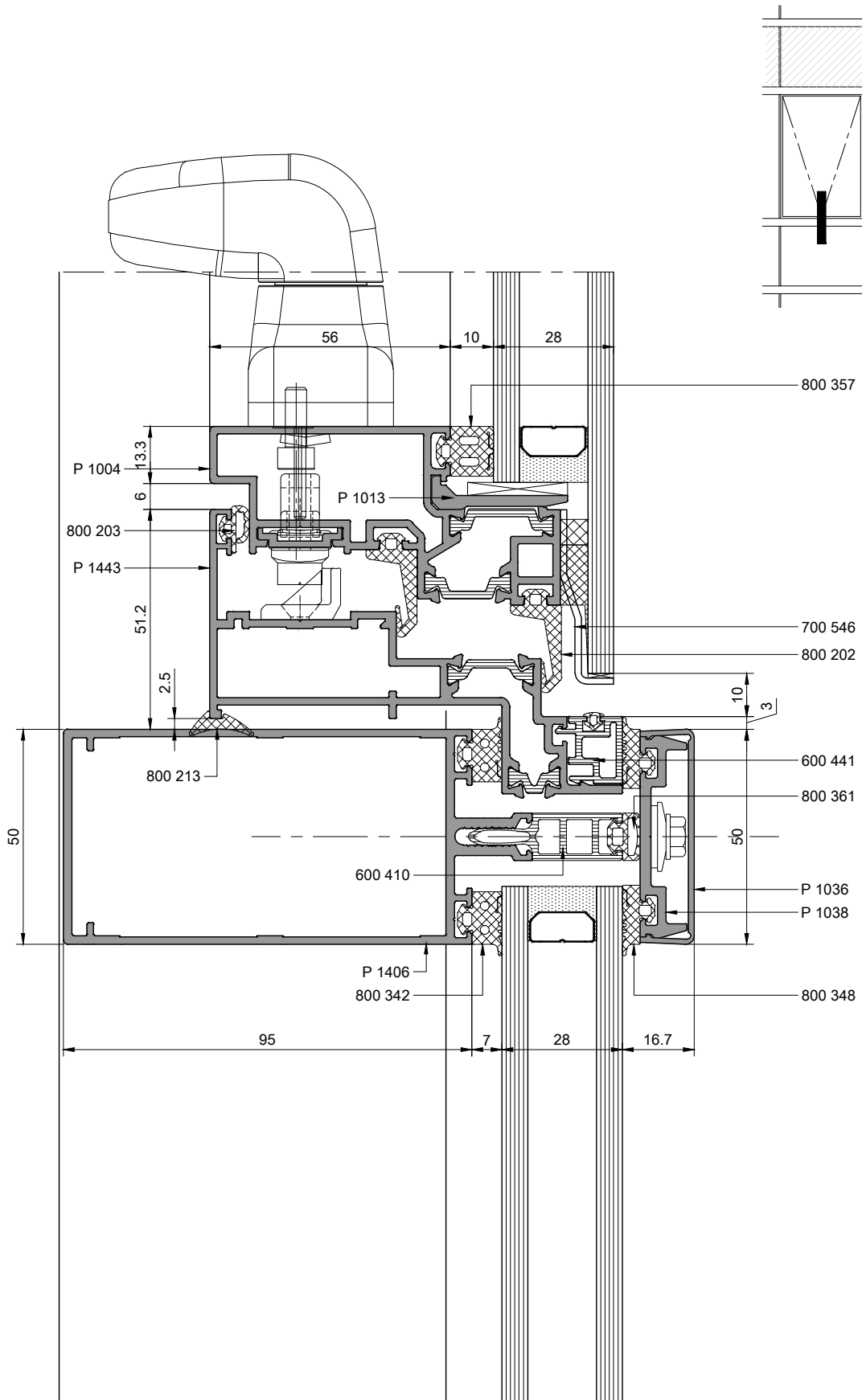

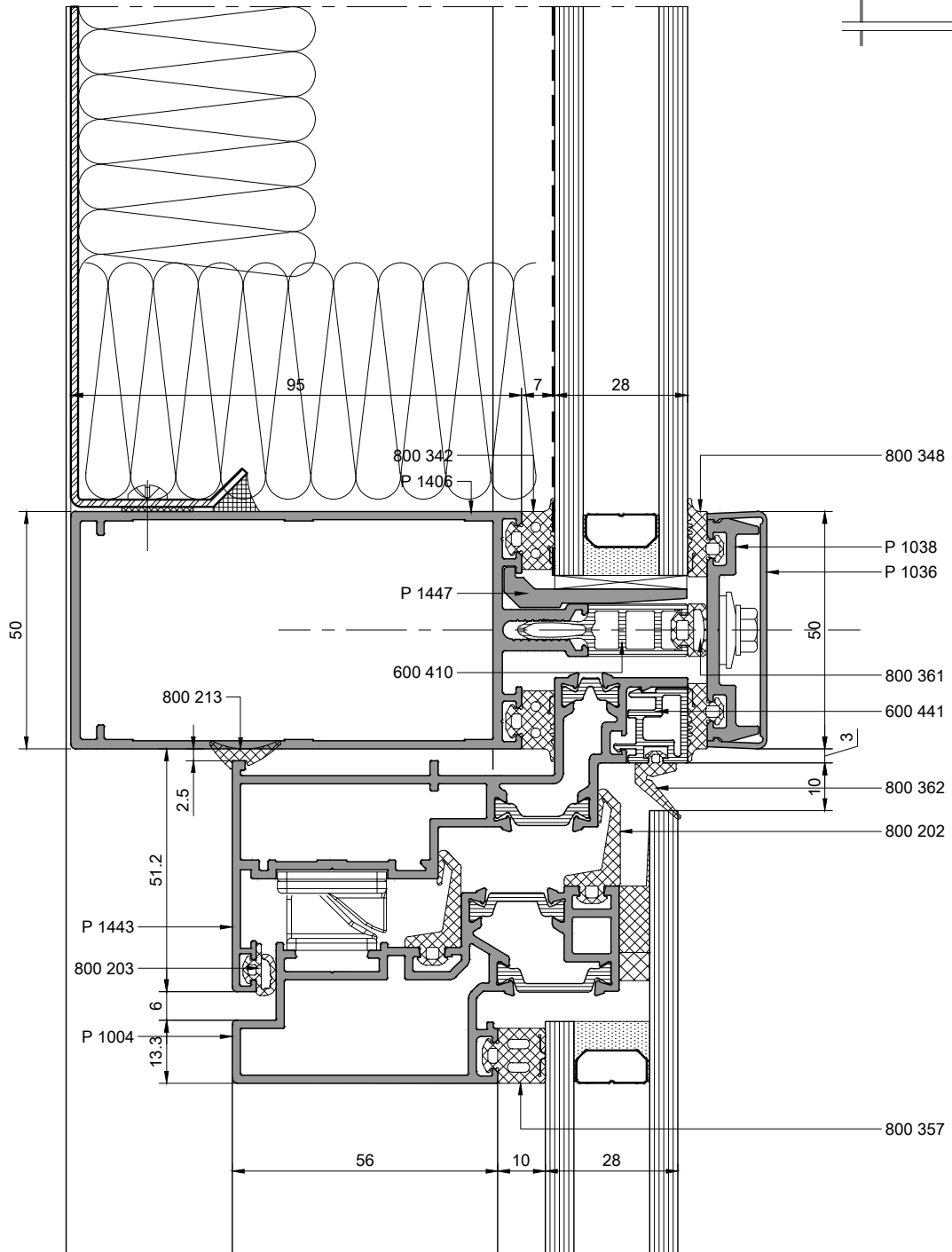
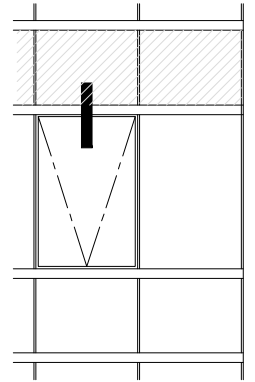

FS50
STICK GİYDİRME CEPHE SİSTEMİ
STICK CURTAIN WALL SYSTEM

SİLİKON CEPHE
SİSTEM DETAYLARI
(CAM İÇİ ALUMİNYUM SPACERLI)
SILICONE FACADE SYSTEM DETAILS
(INSIDE GLASS ALUMINIUM SPACER)

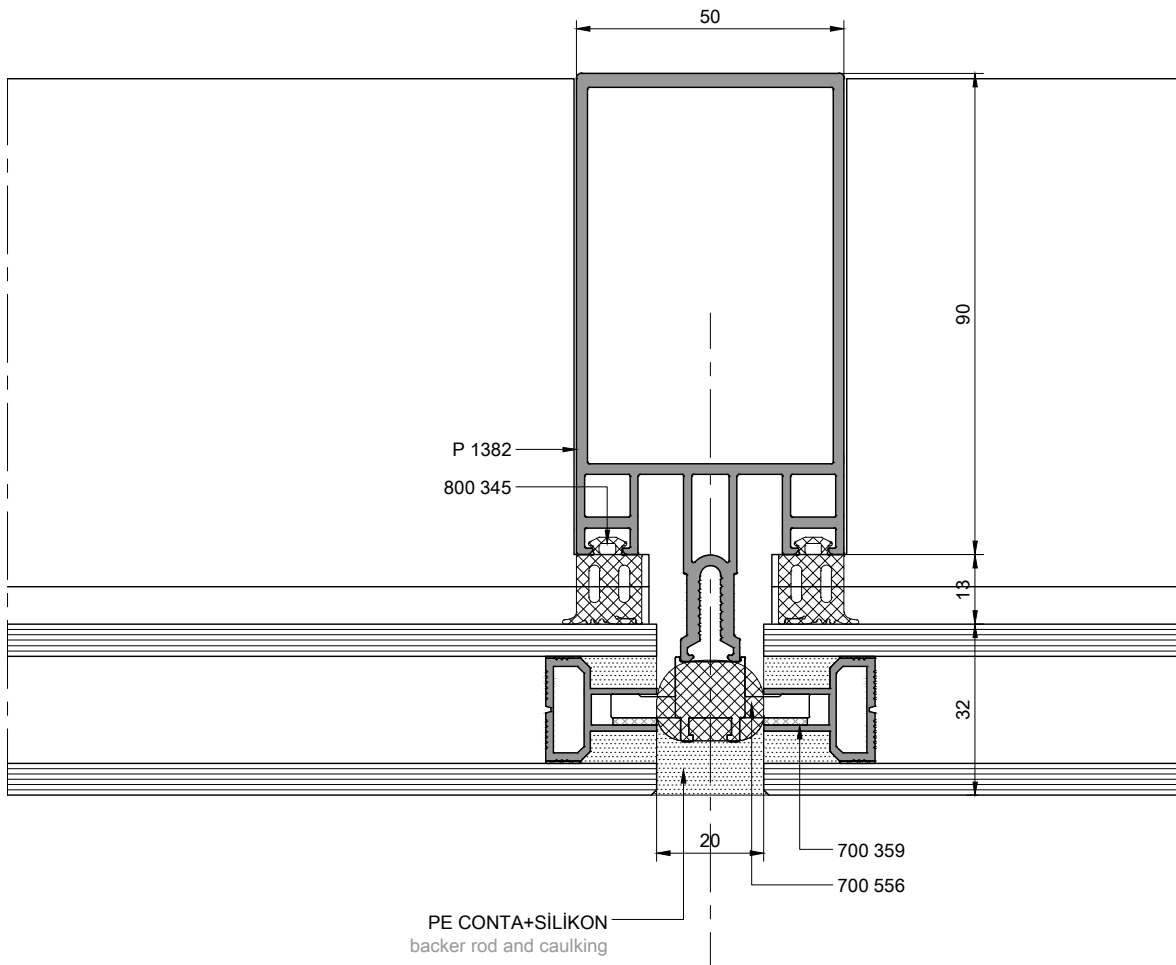
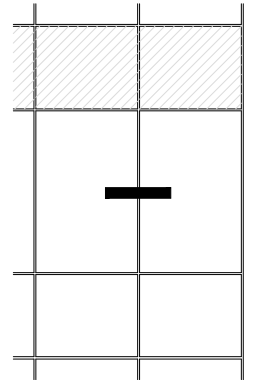

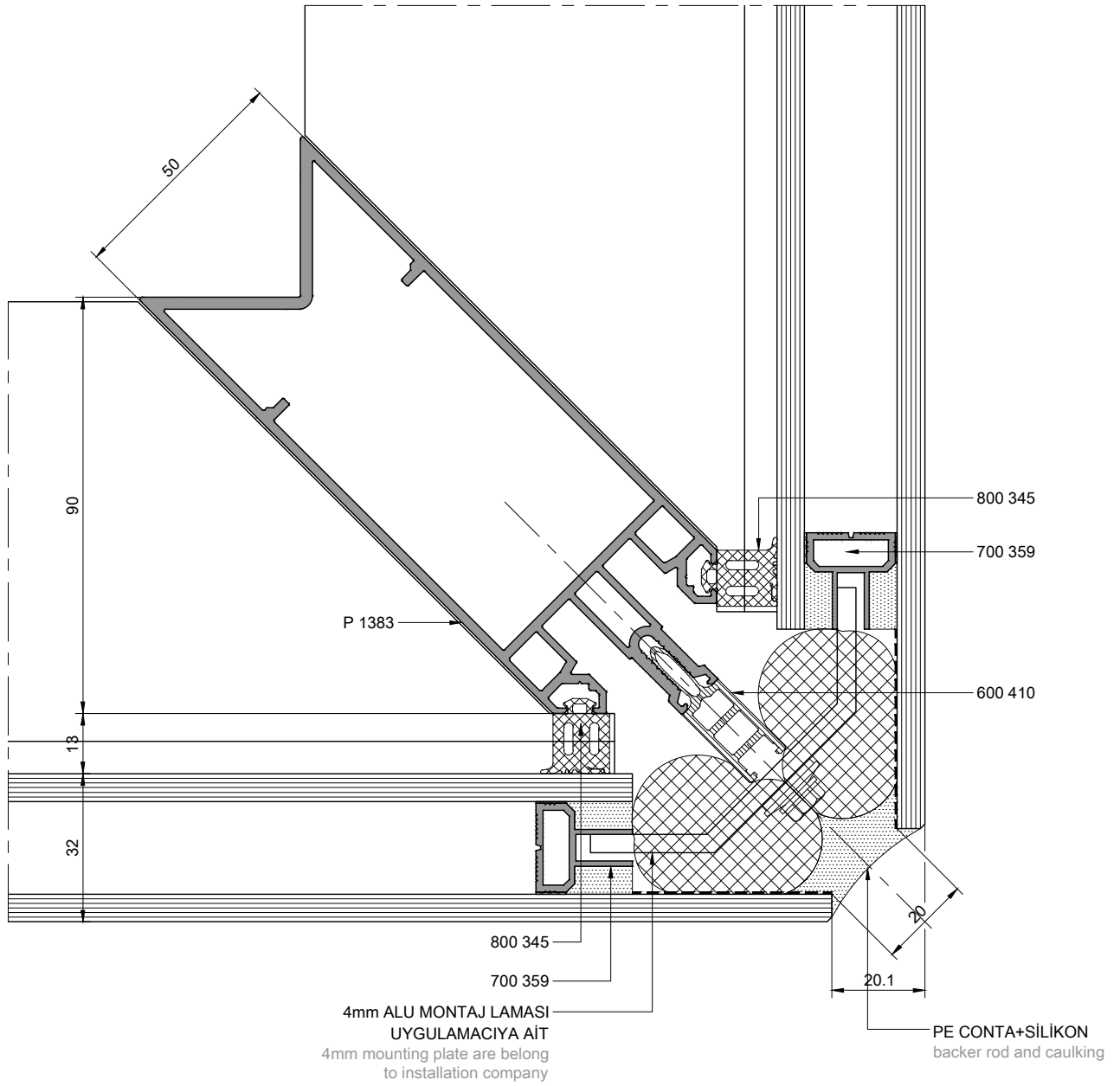
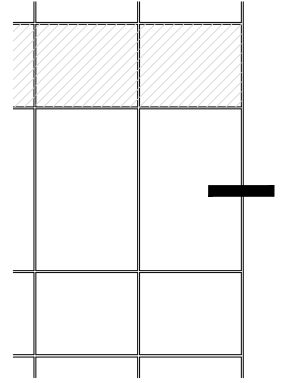

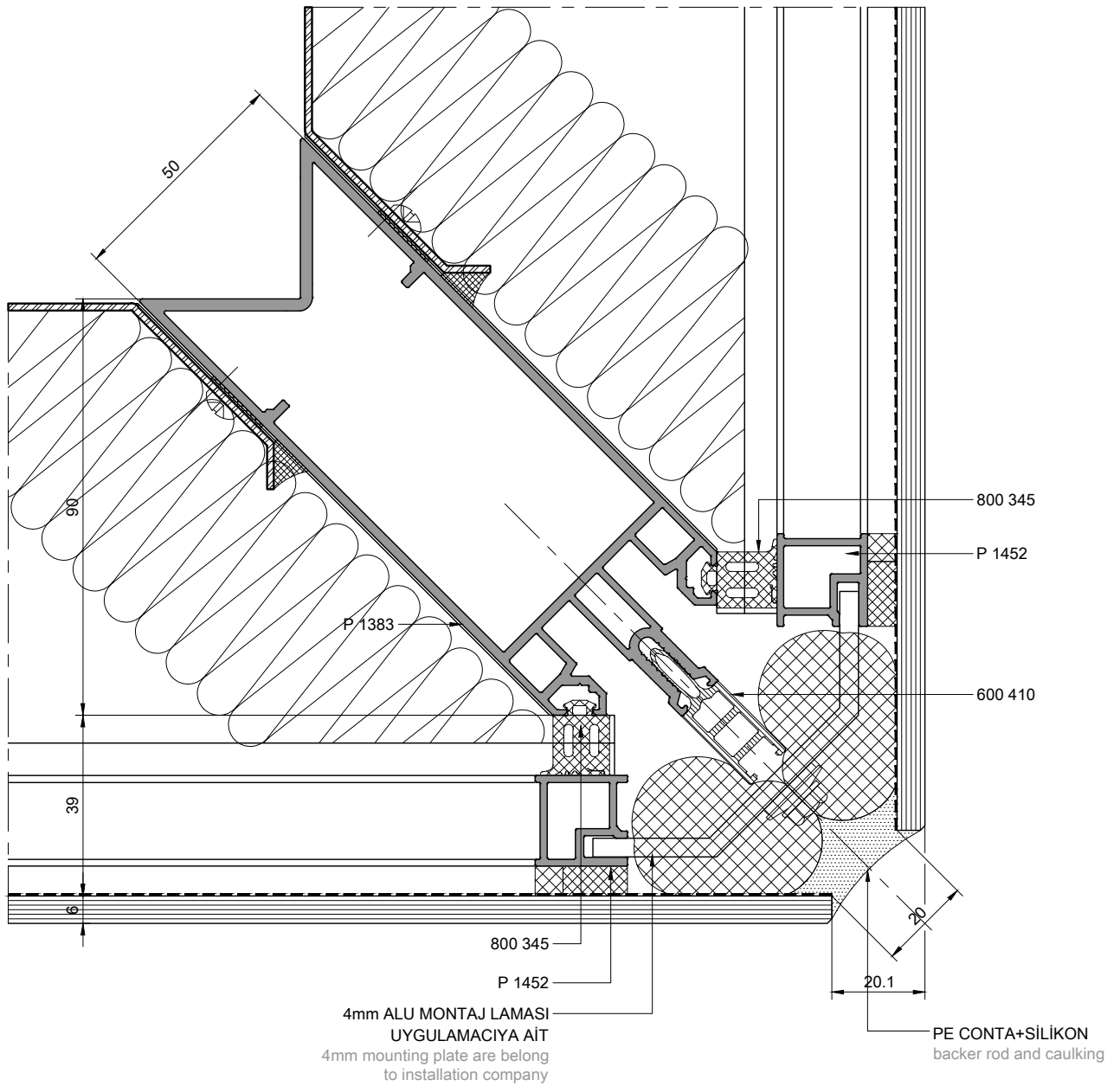
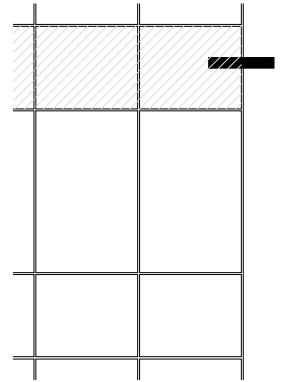

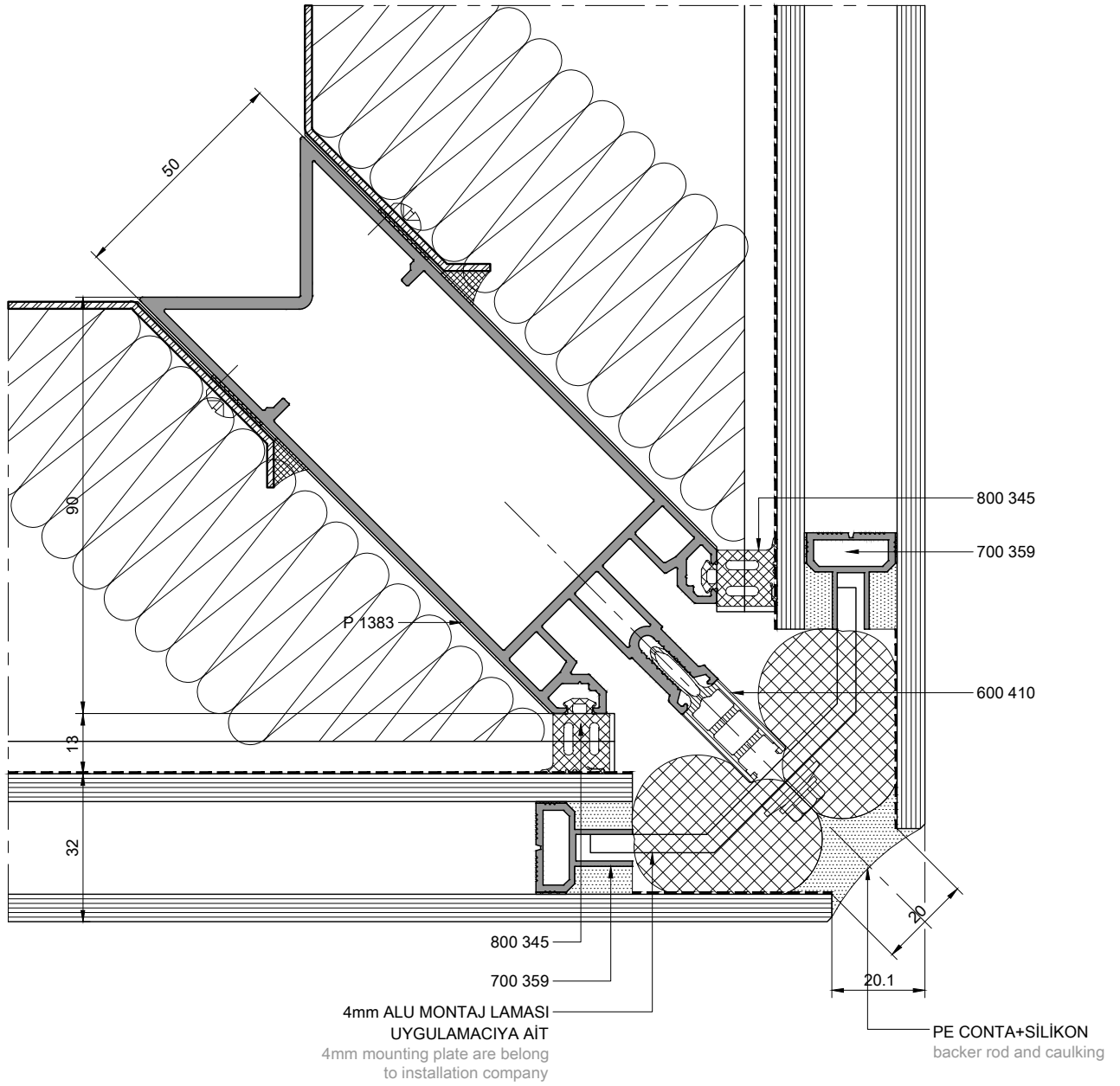
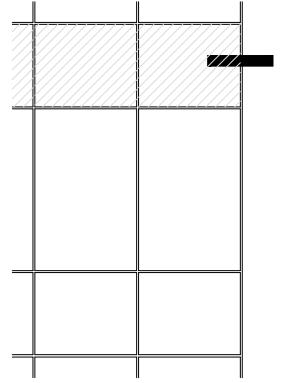

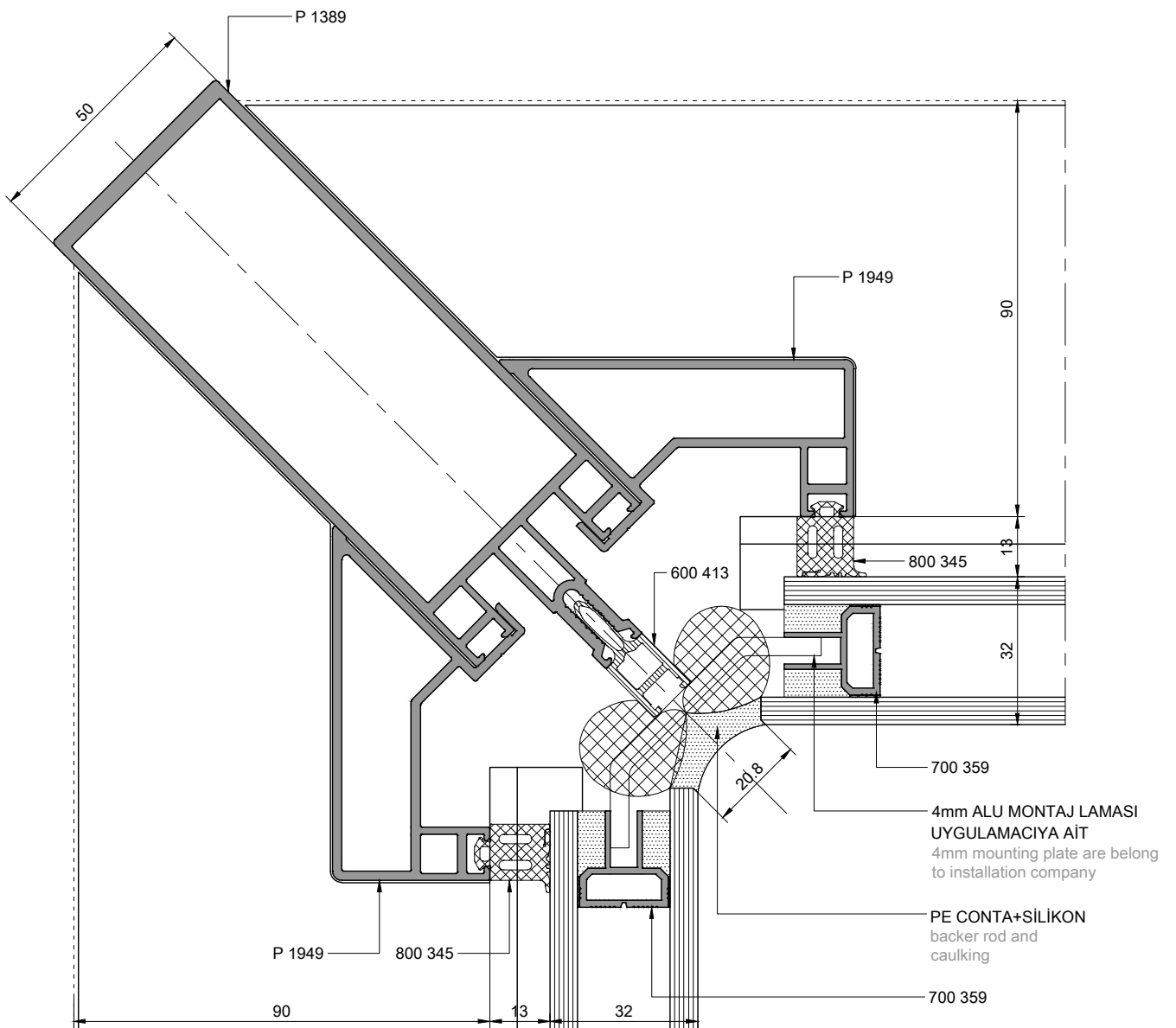
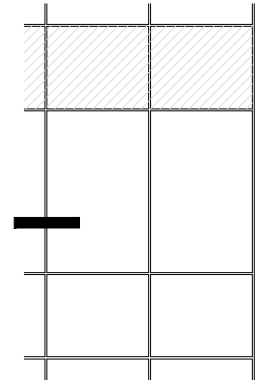

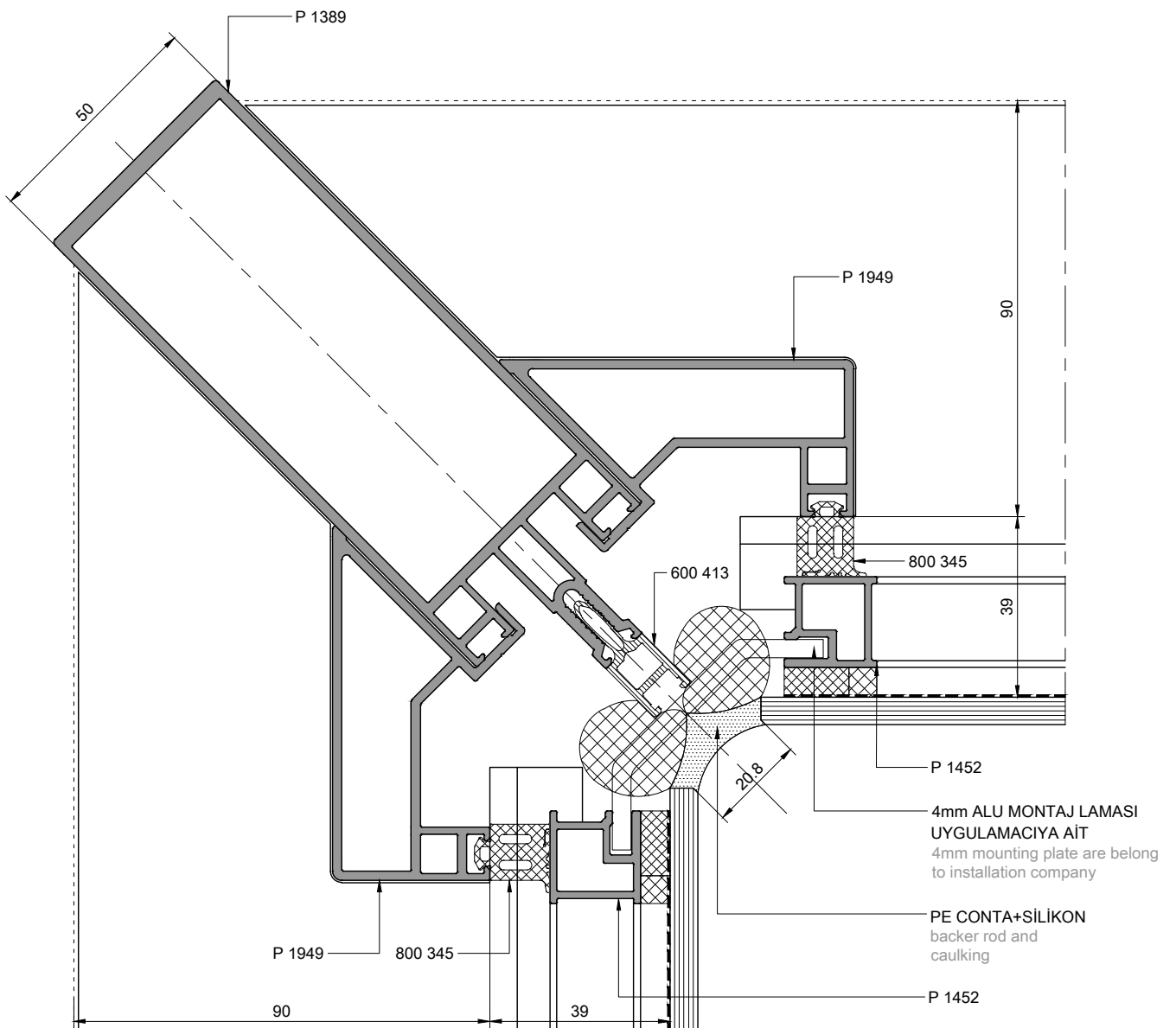
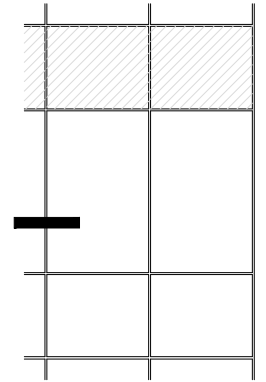

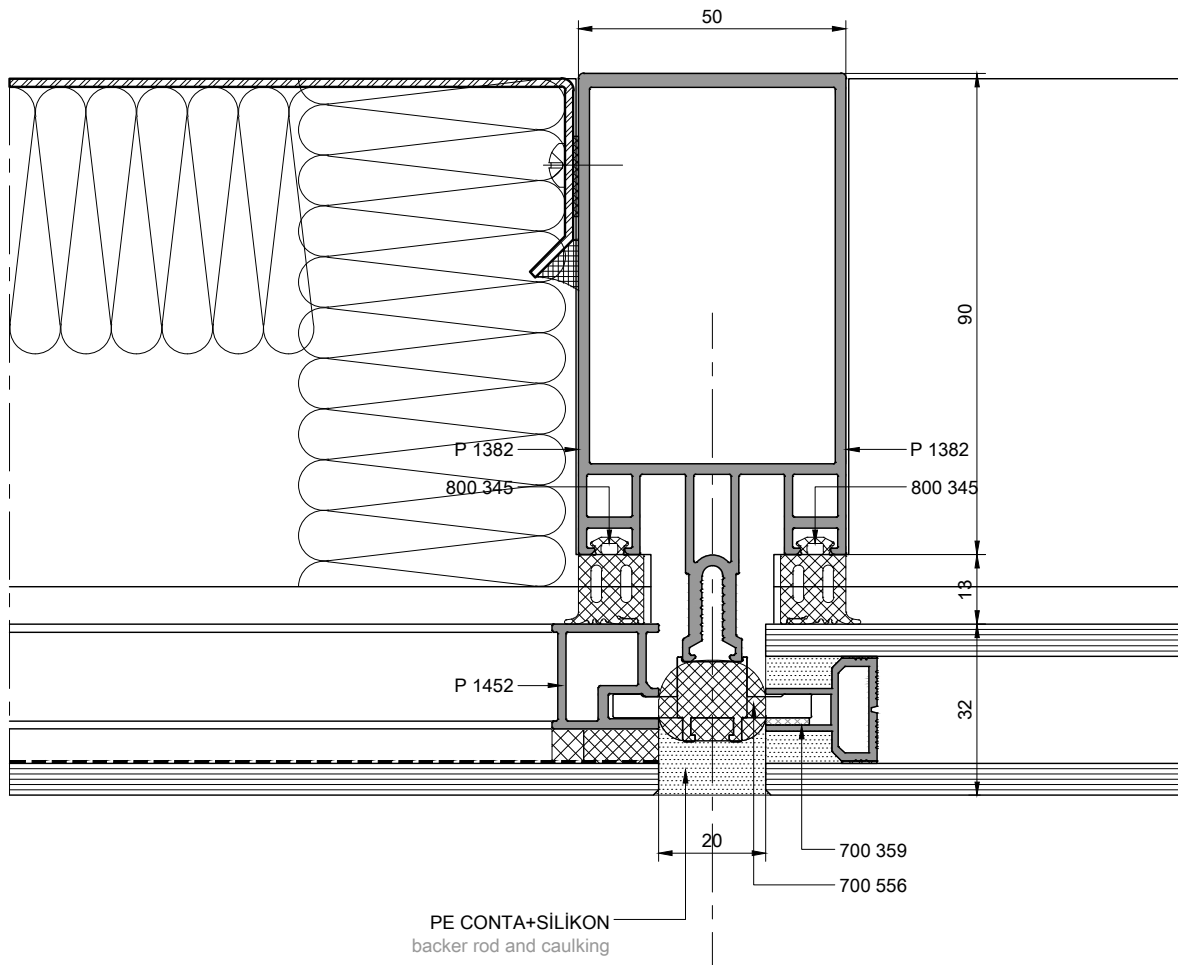
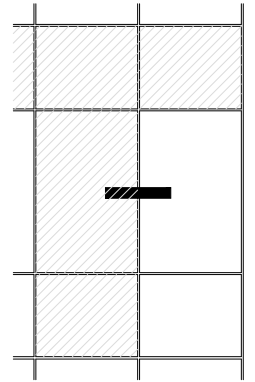

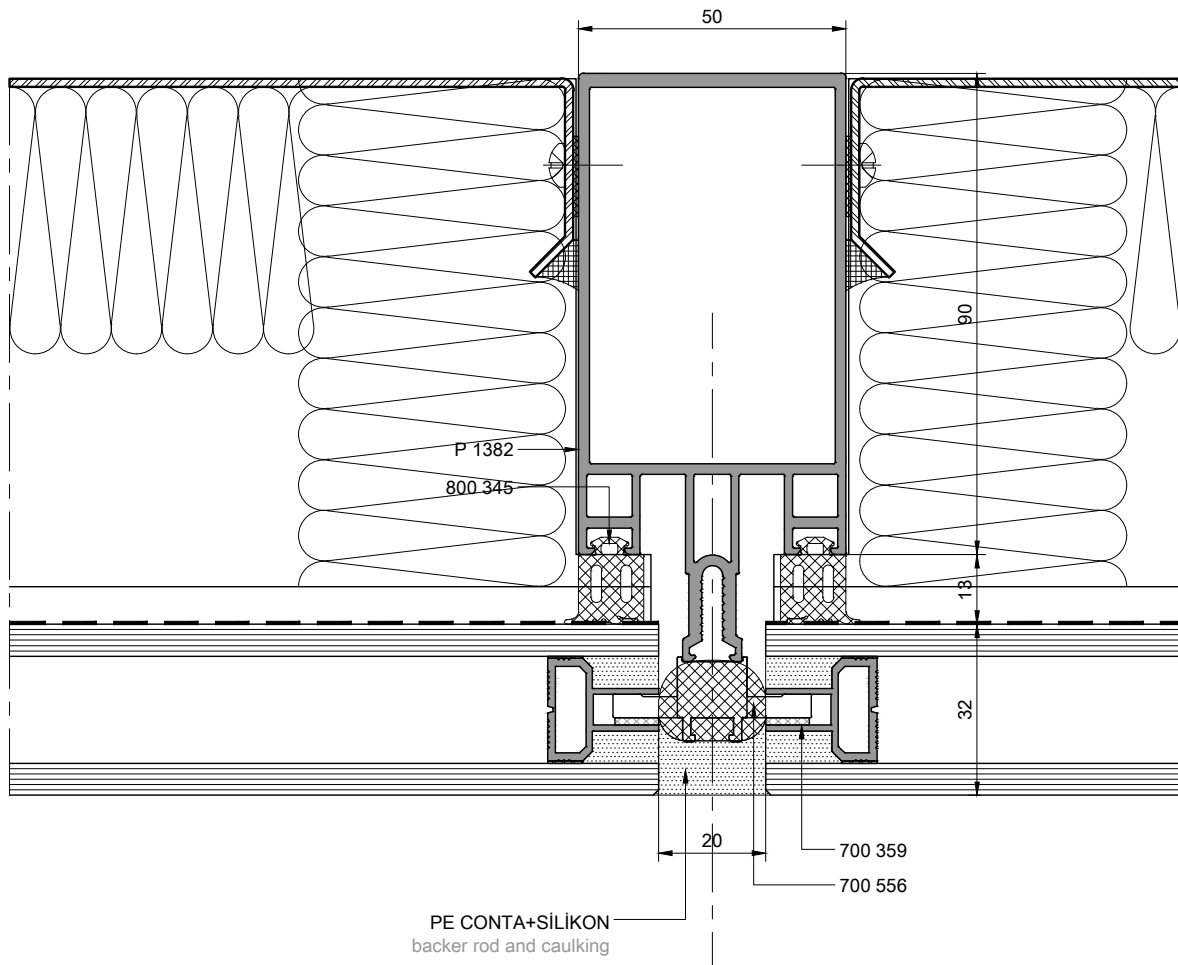
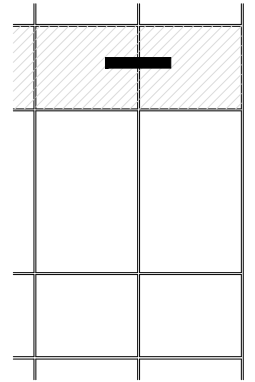

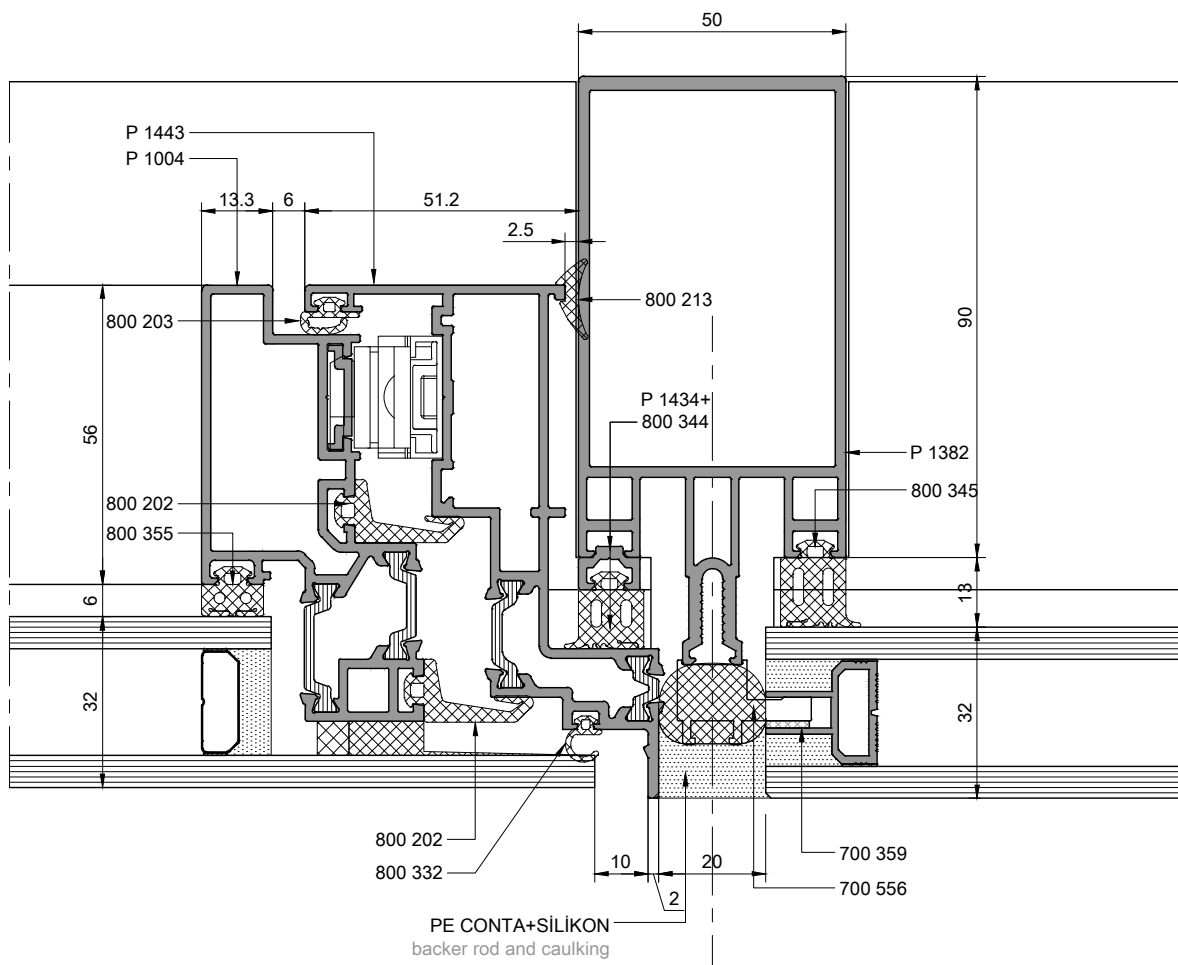
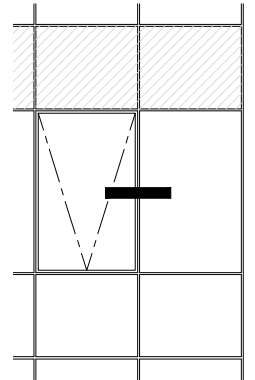

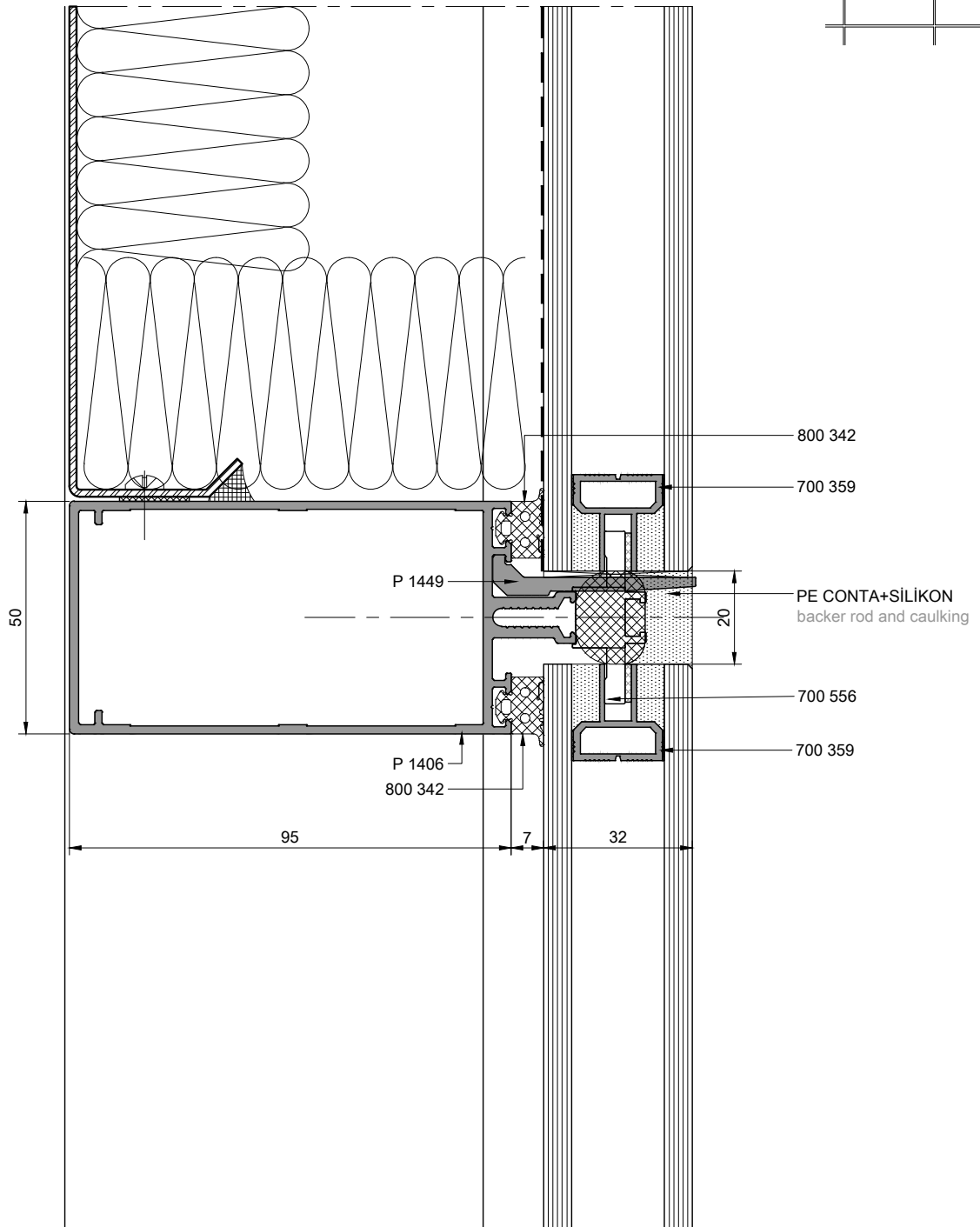
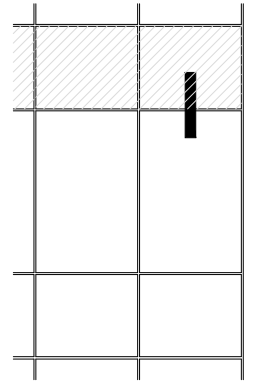

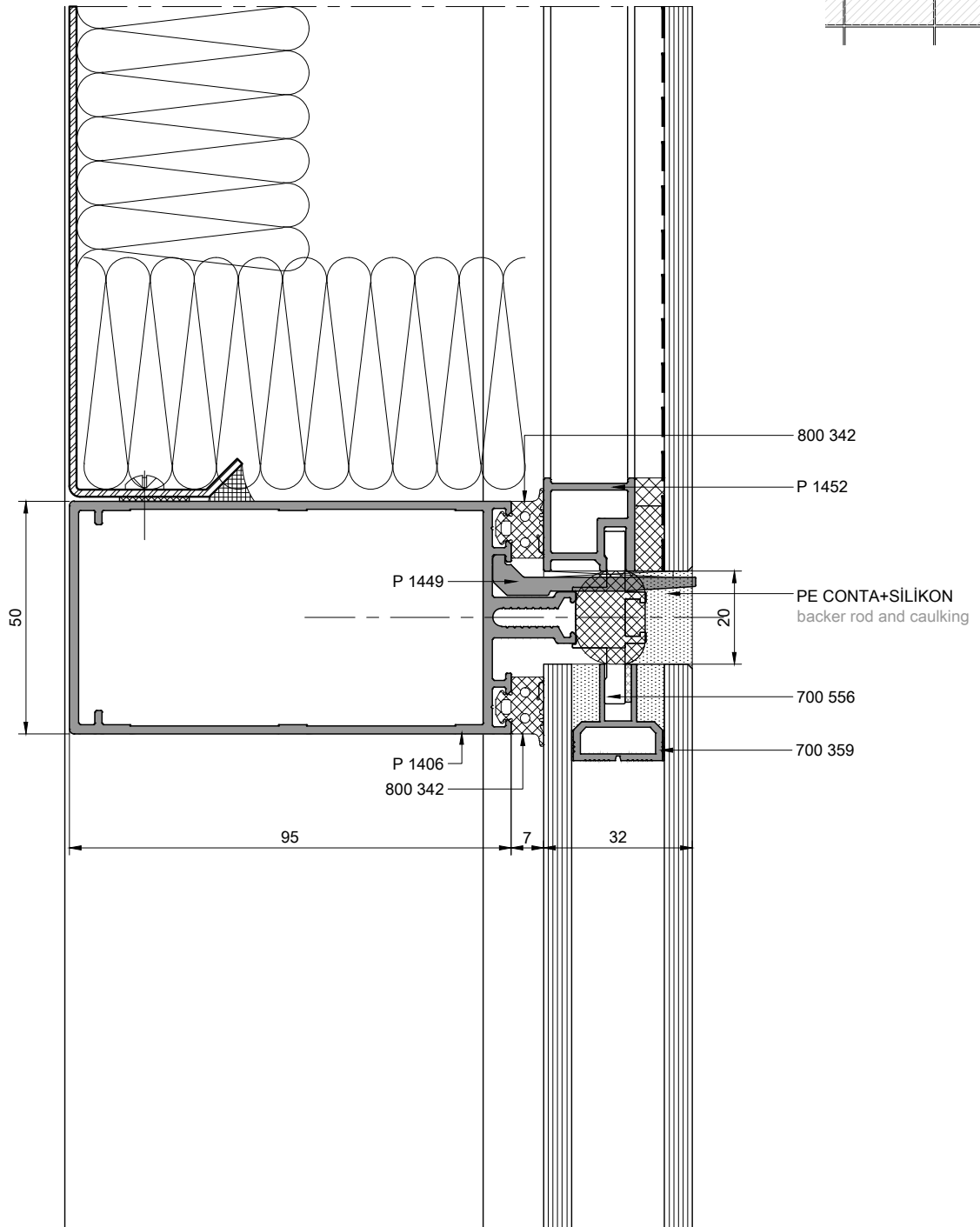
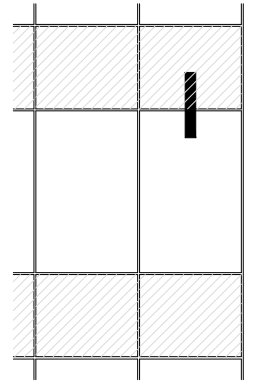

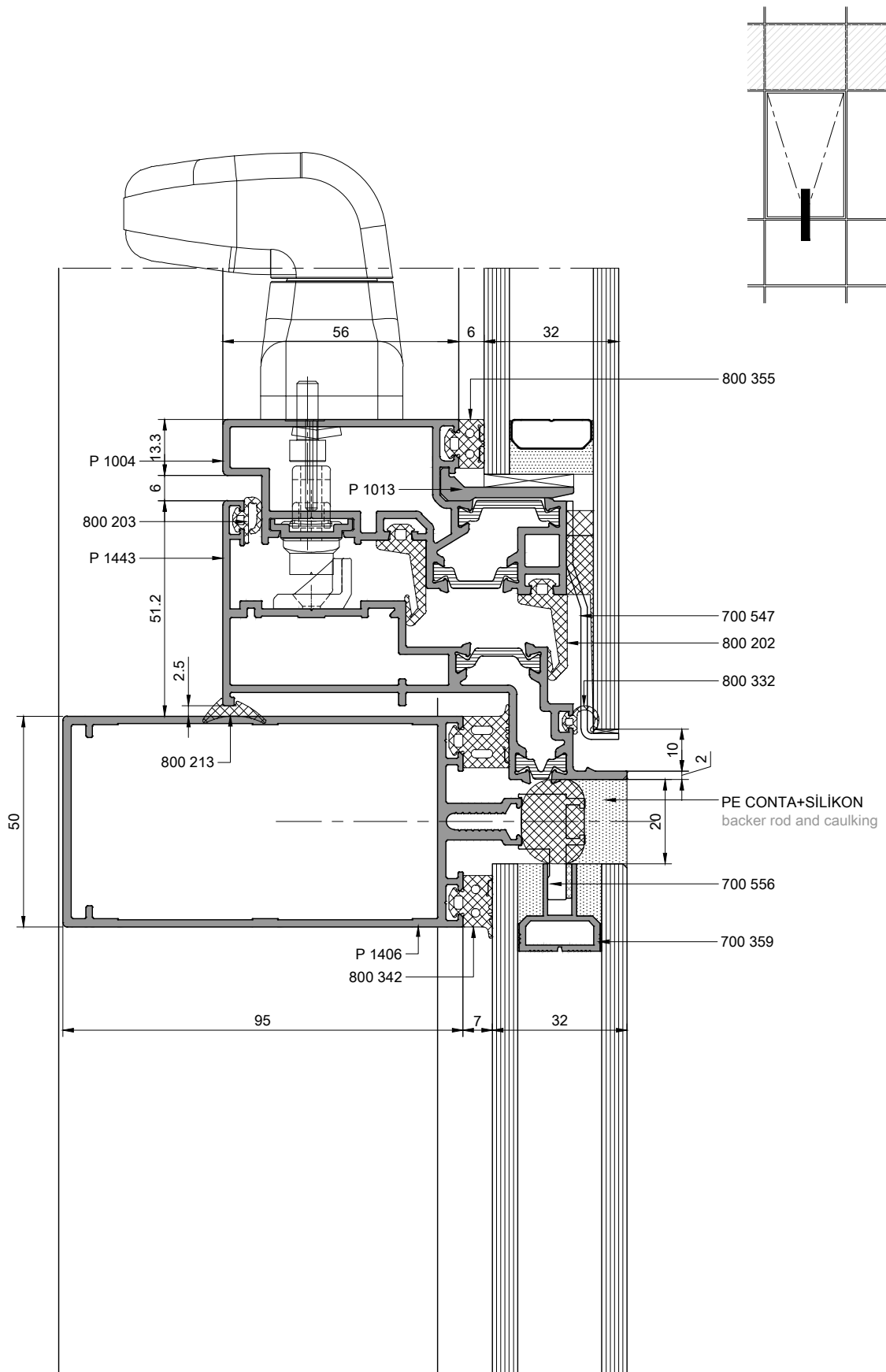

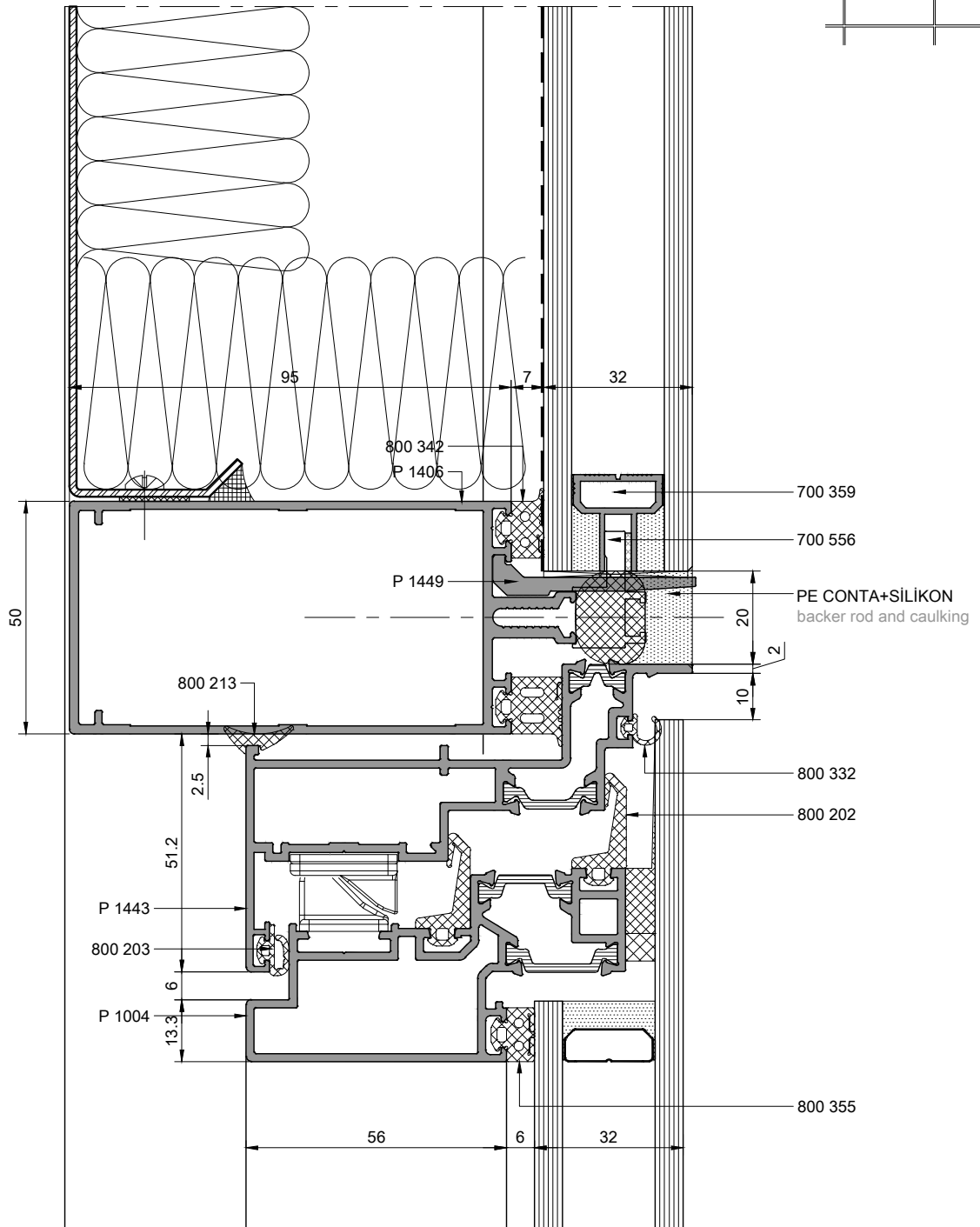
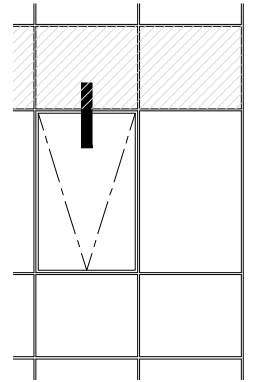

FS50
STICK GİYDİRME CEPHE SİSTEMİ
STICK CURTAIN WALL SYSTEM

DÜŞEY KAPAKLI SİLİKON CEPHE
SİSTEM DETAYLARI
(CAM İÇİ ALUMİNYUM SPACERLI)
VERTICAL CAPPED SILICONE FACADE
SYSTEM DETAILS
(INSIDE GLASS ALUMINIUM SPACER)

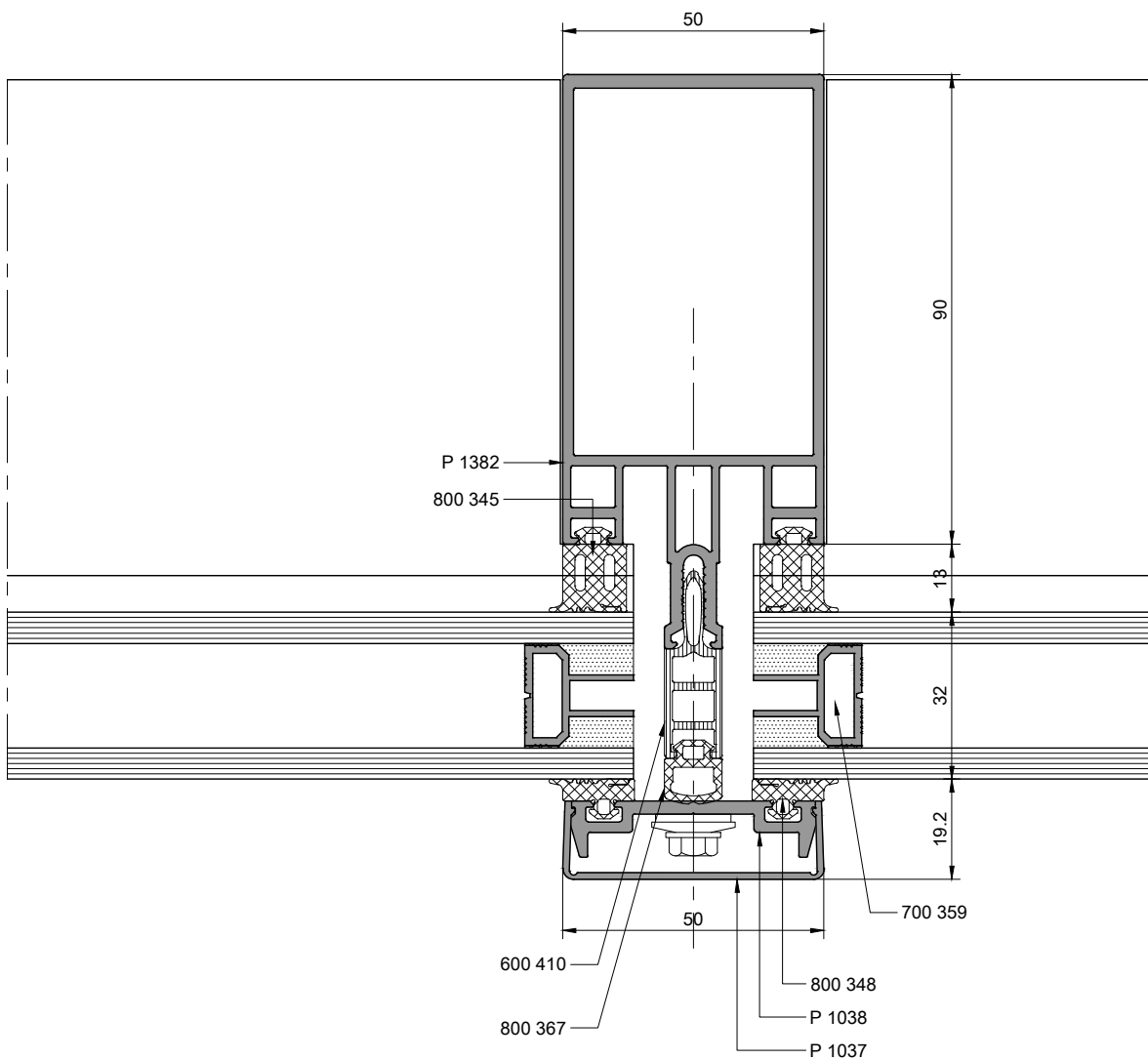
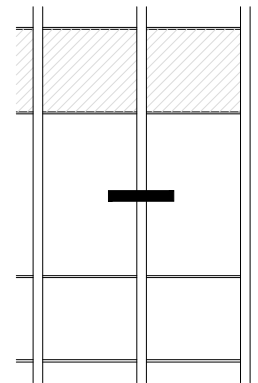

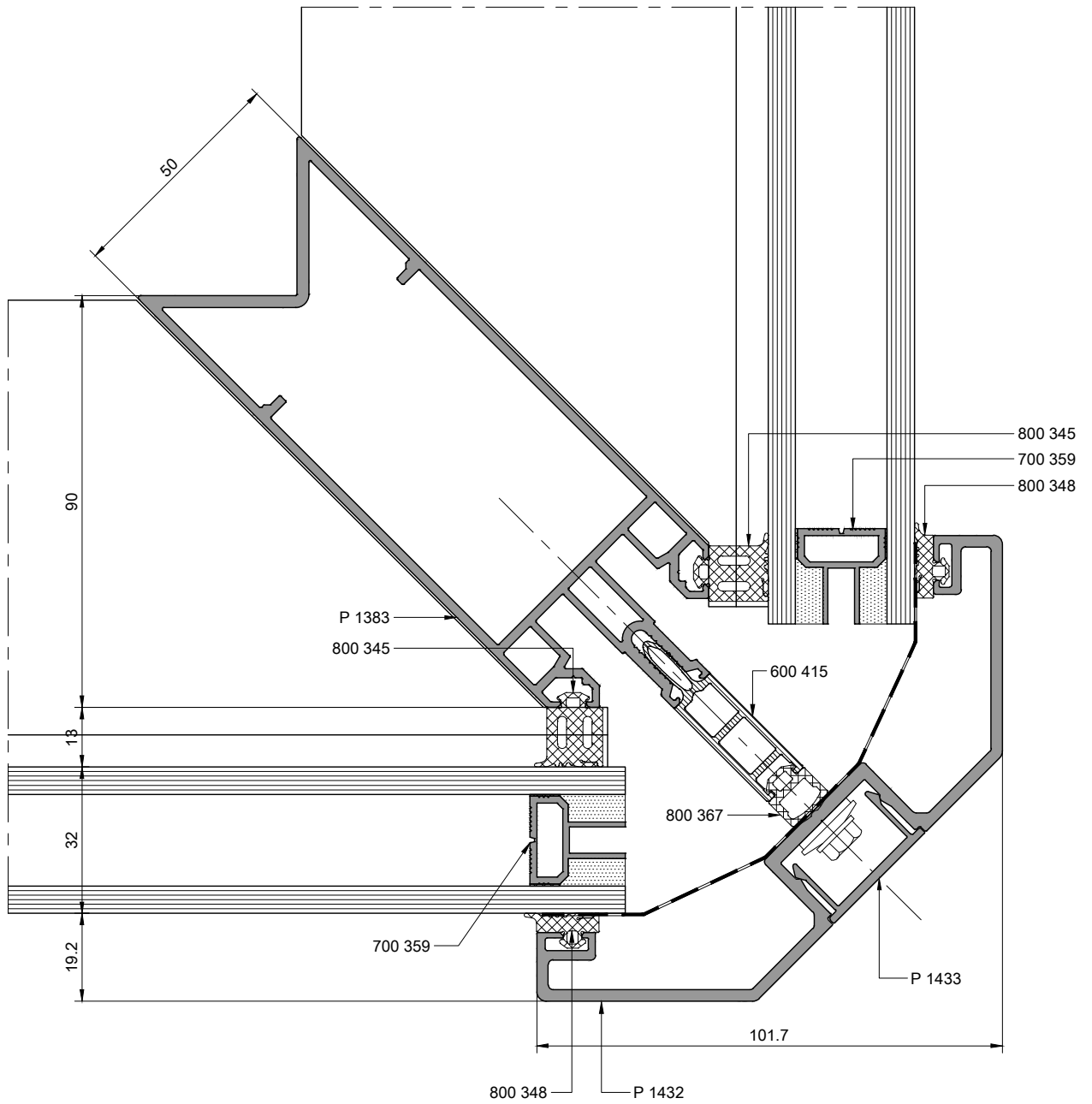
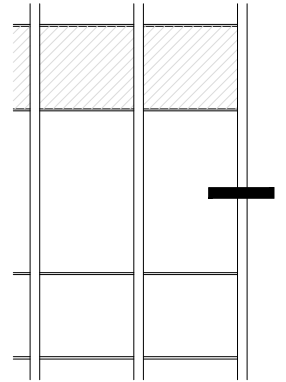

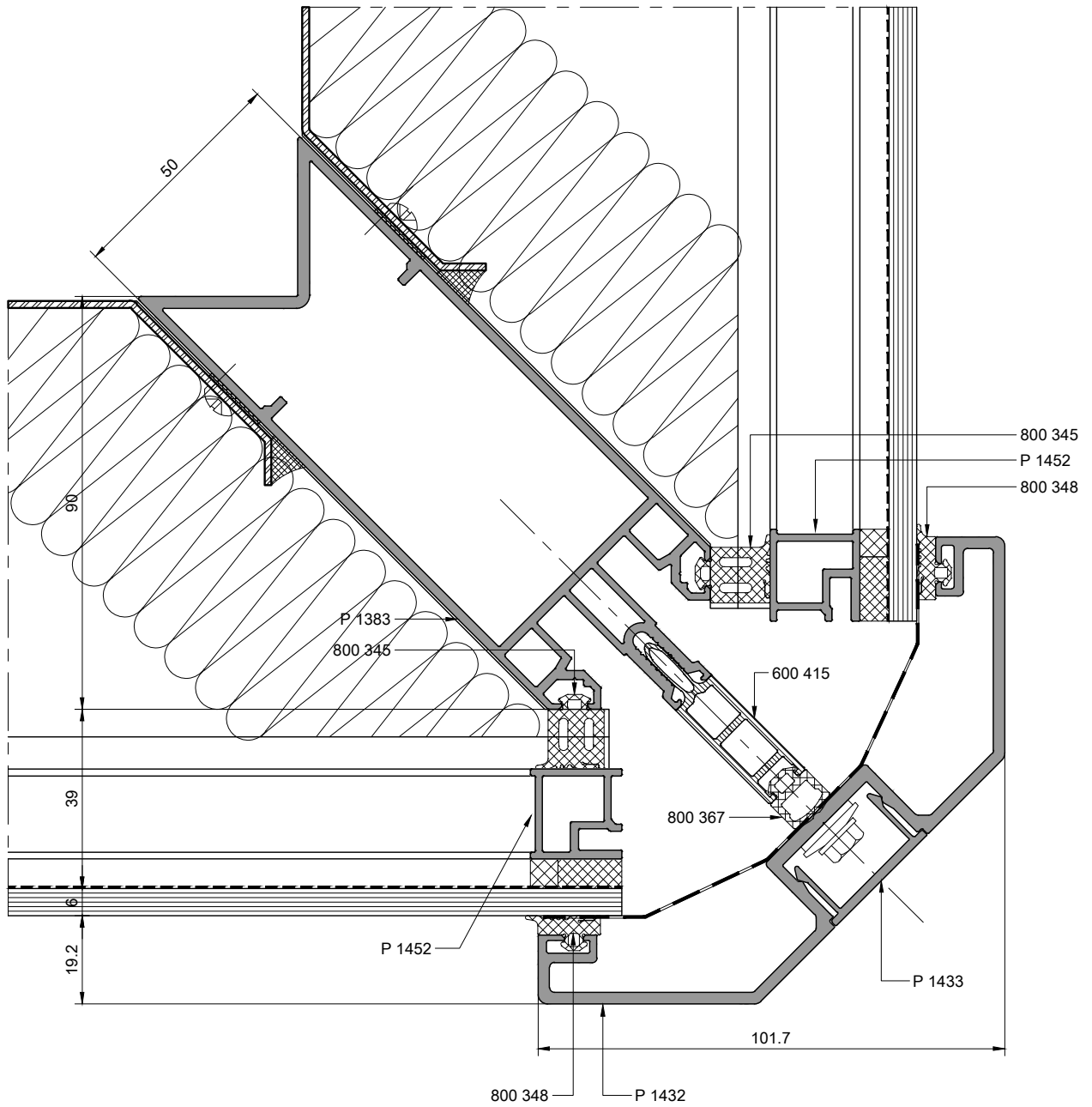
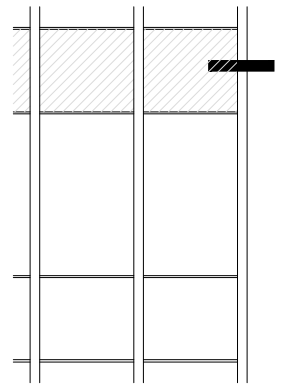

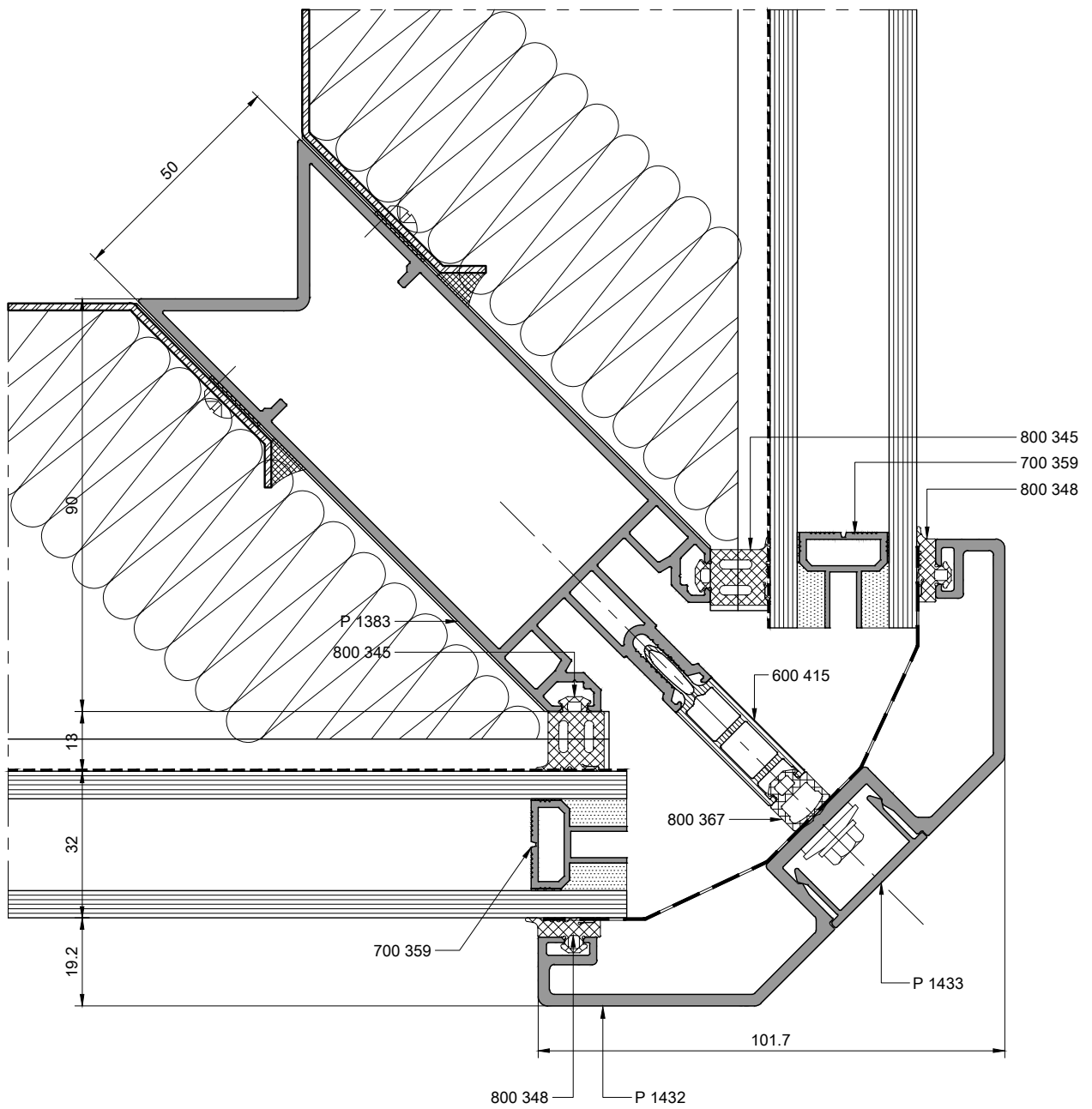
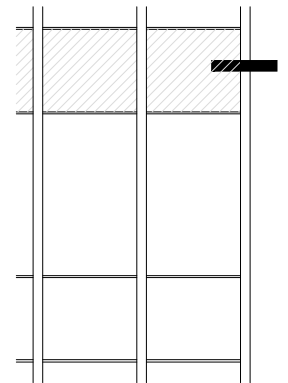

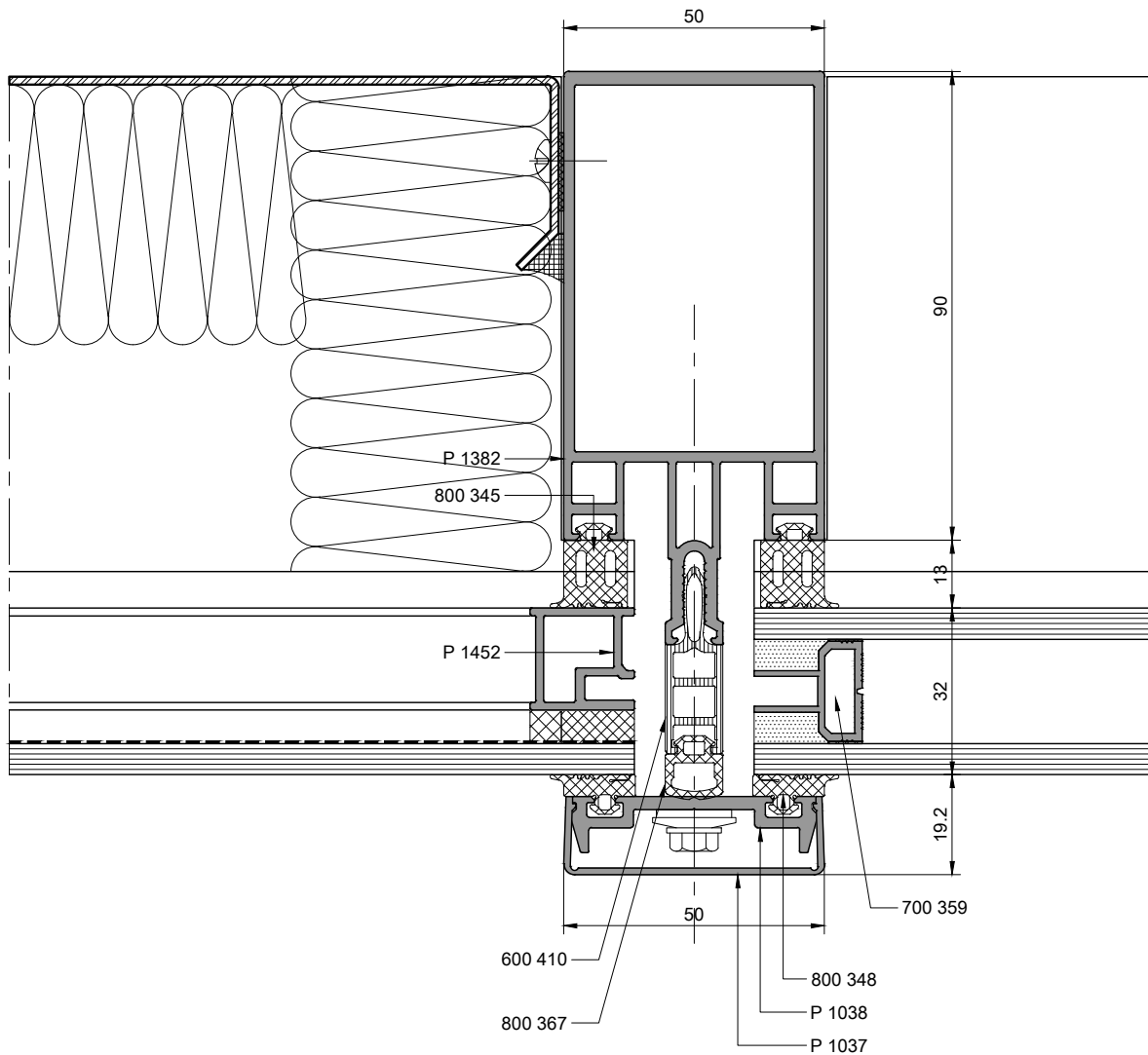
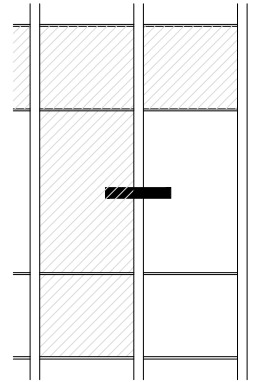

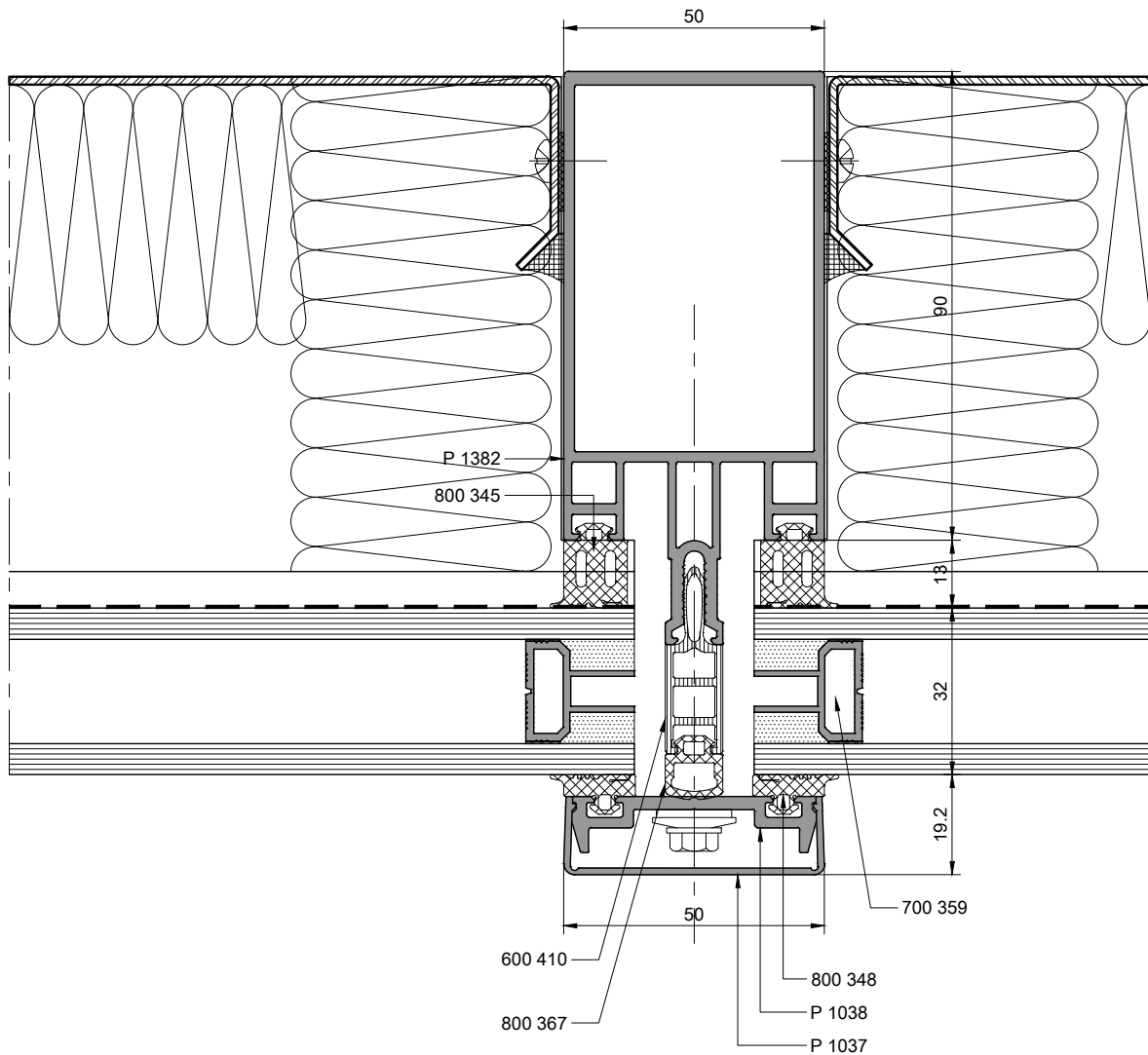
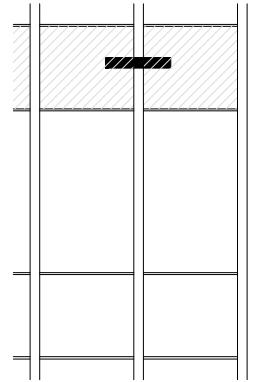

FS50
STICK GİYDİRME CEPHE SİSTEMİ
STICK CURTAIN WALL SYSTEM

YATAY KAPAKLI SİLİKON CEPHE
SİSTEM DETAYLARI
(CAM İÇİ ALUMİNYUM SPACERLI)
HORIZONTAL CAPPED SILICONE FACADE
SYSTEM DETAILS
(INSIDE GLASS ALUMINIUM SPACER)

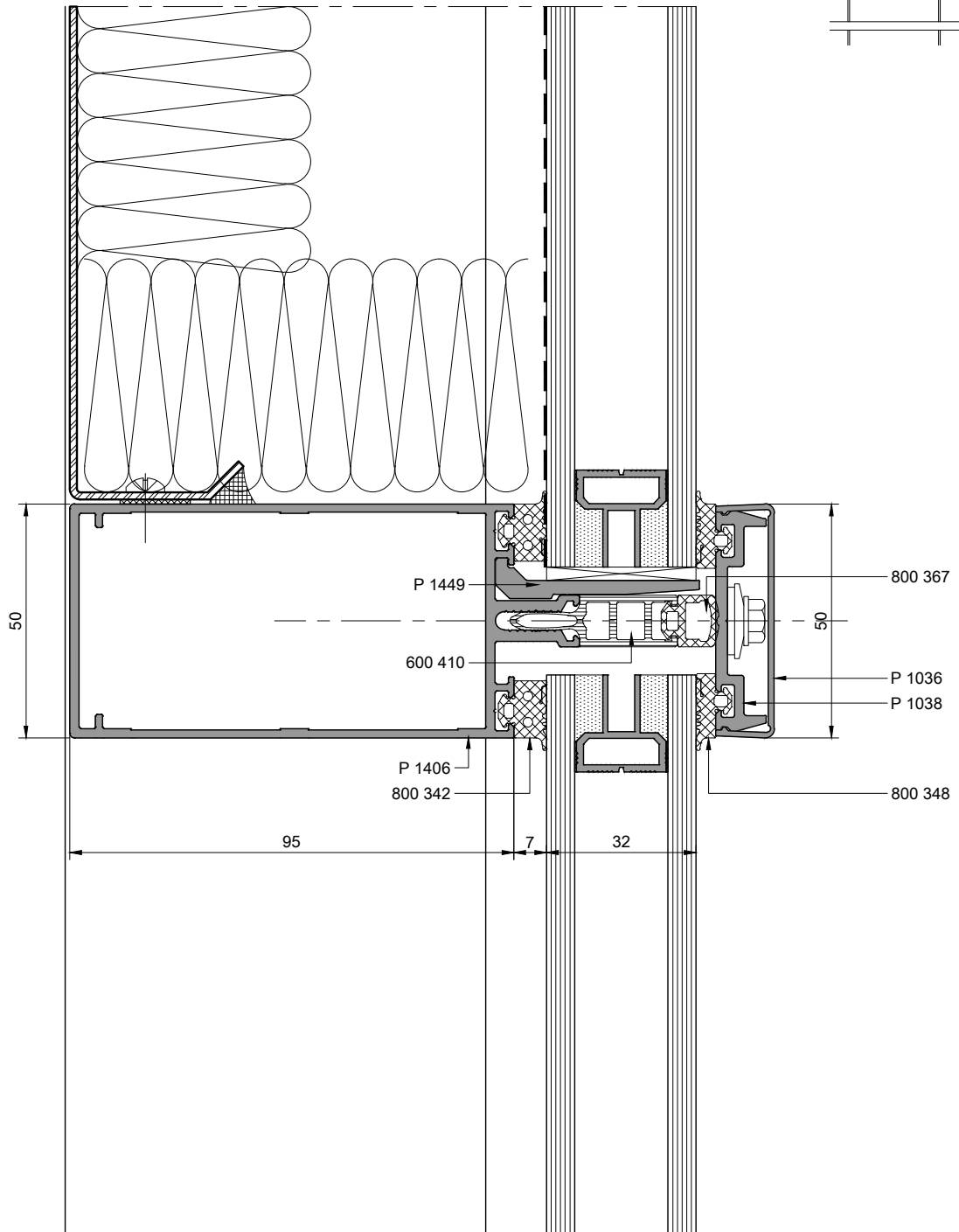
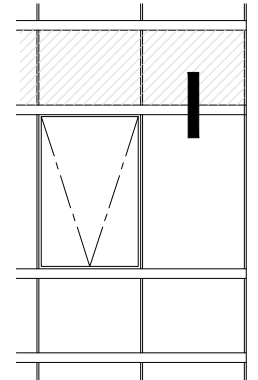

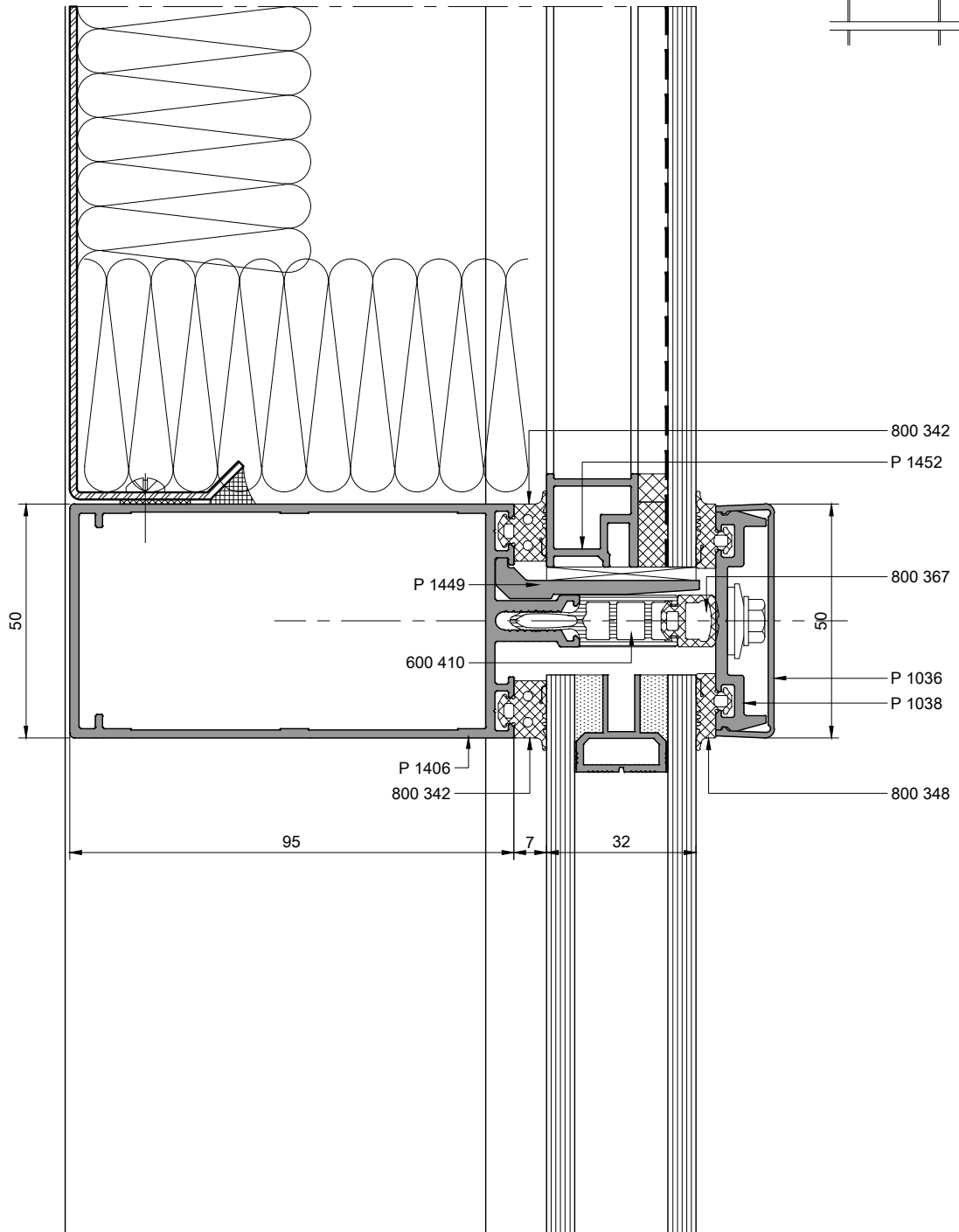
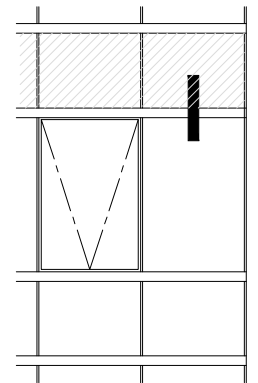

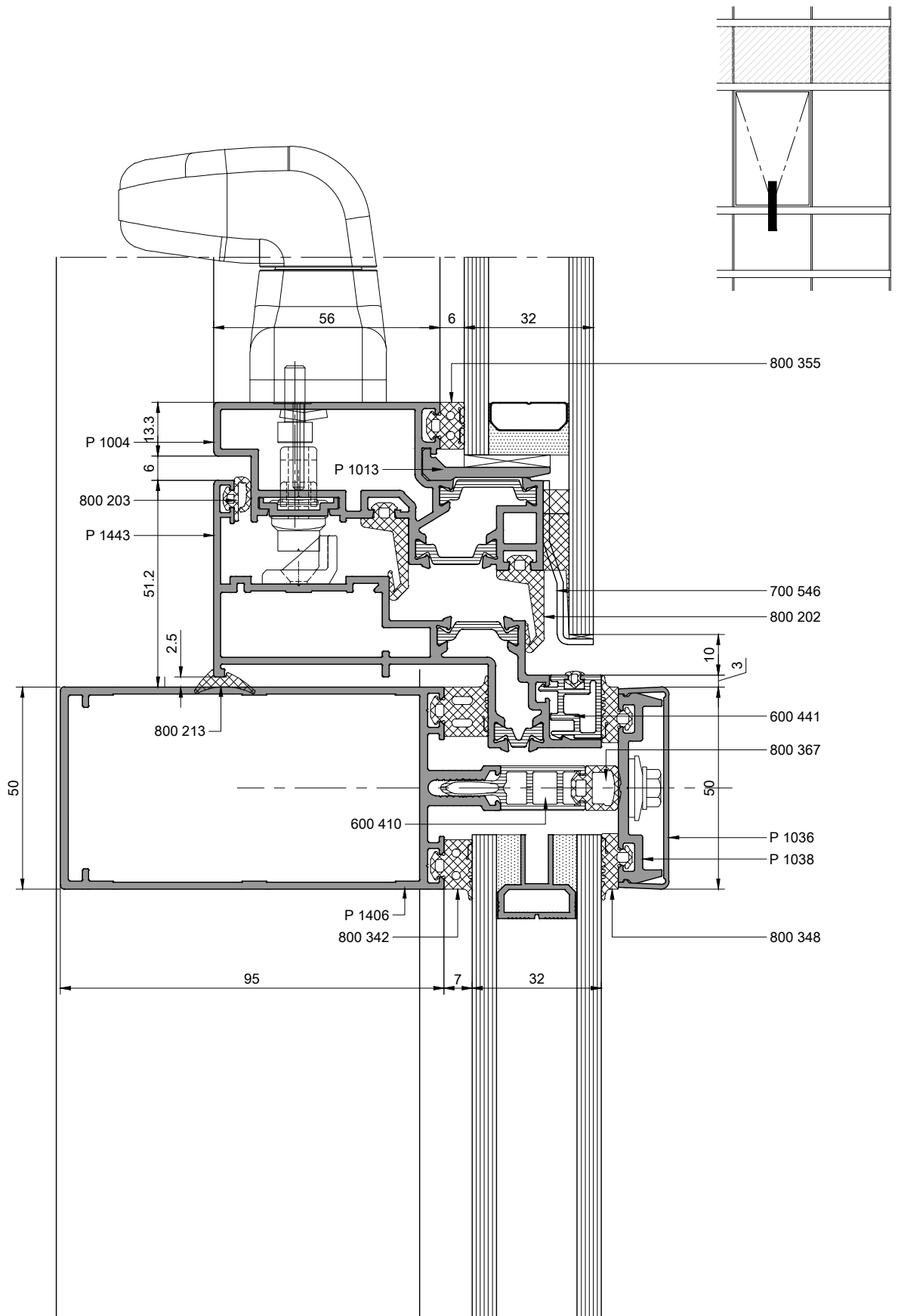

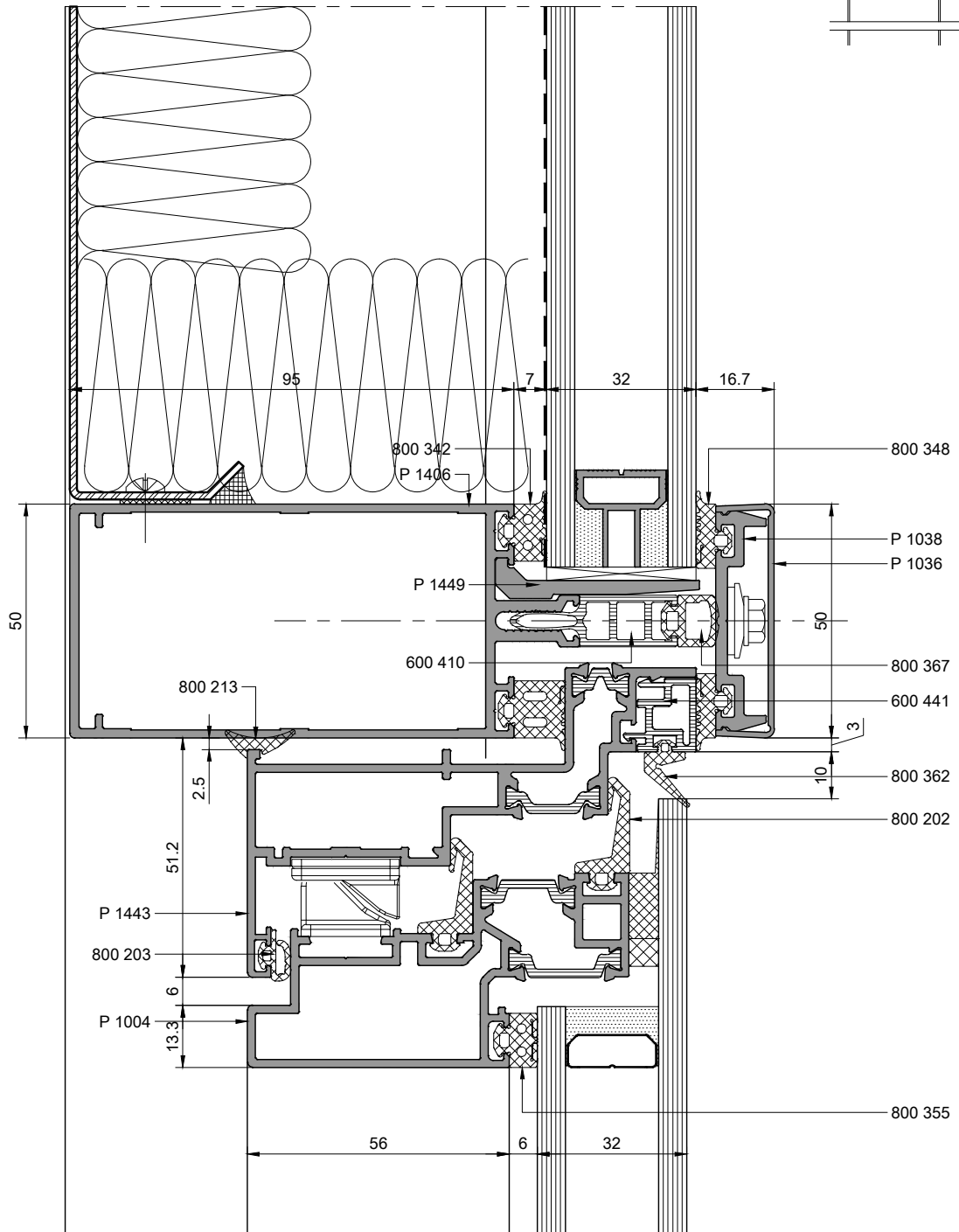
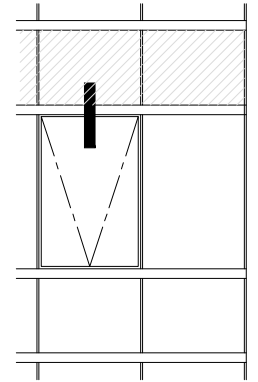

FS50
STICK GİYDİRME CEPHE SİSTEMİ
STICK CURTAIN WALL SYSTEM

KAPAKLI CEPHE
İÇİ BASIC56
PENCERE BİRLEŞİM DETAYLARI
CAPPED FACADE DETAILS WITH BASIC56
WINDOW SYSTEM

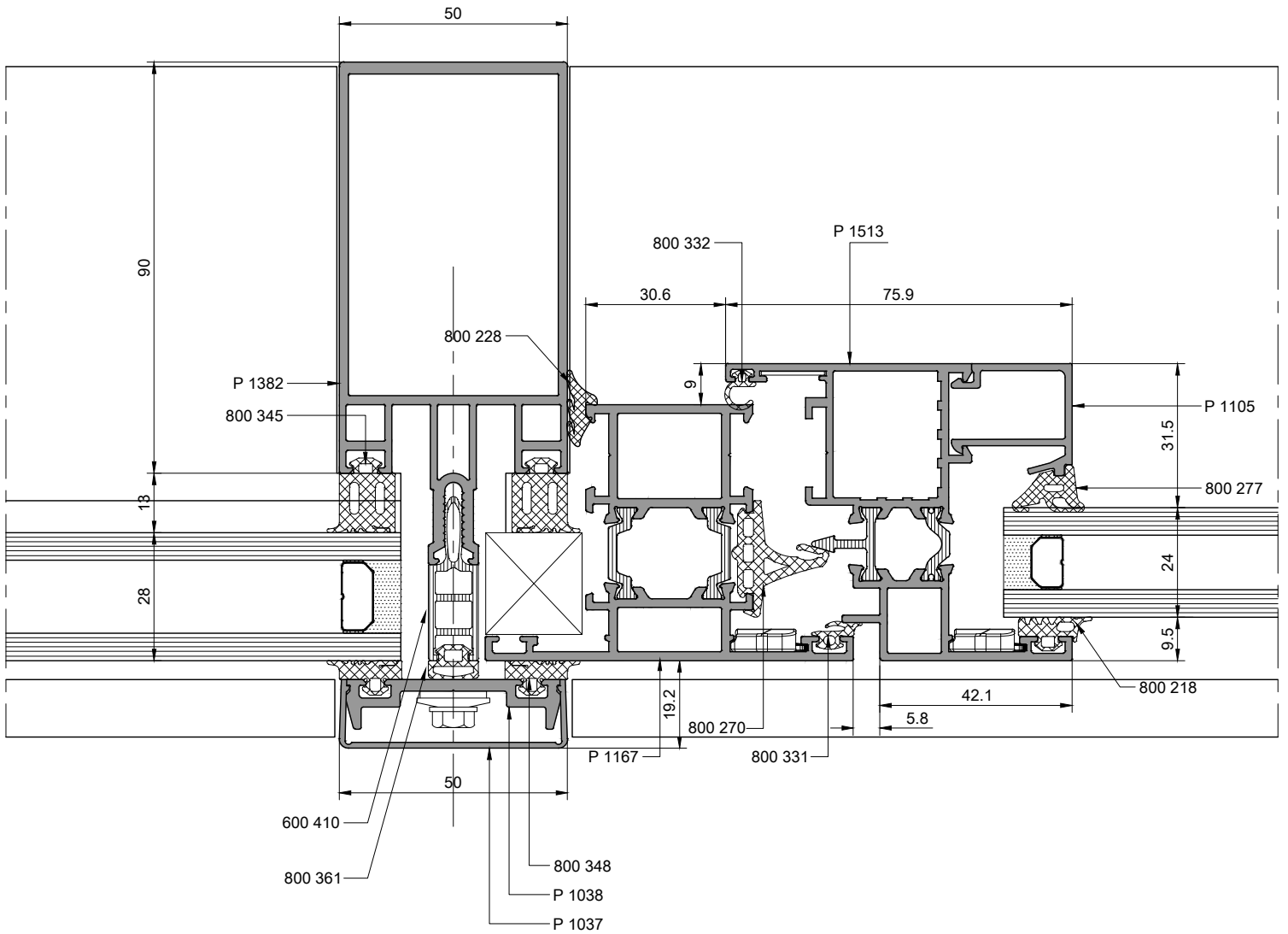
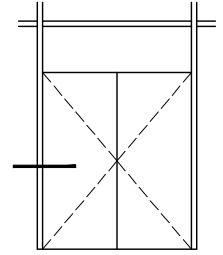

Daha fazla bilgi için BASIC56
kataloguna bakınız
to gate more information please
have o look at BASIC56 catalogue
G60

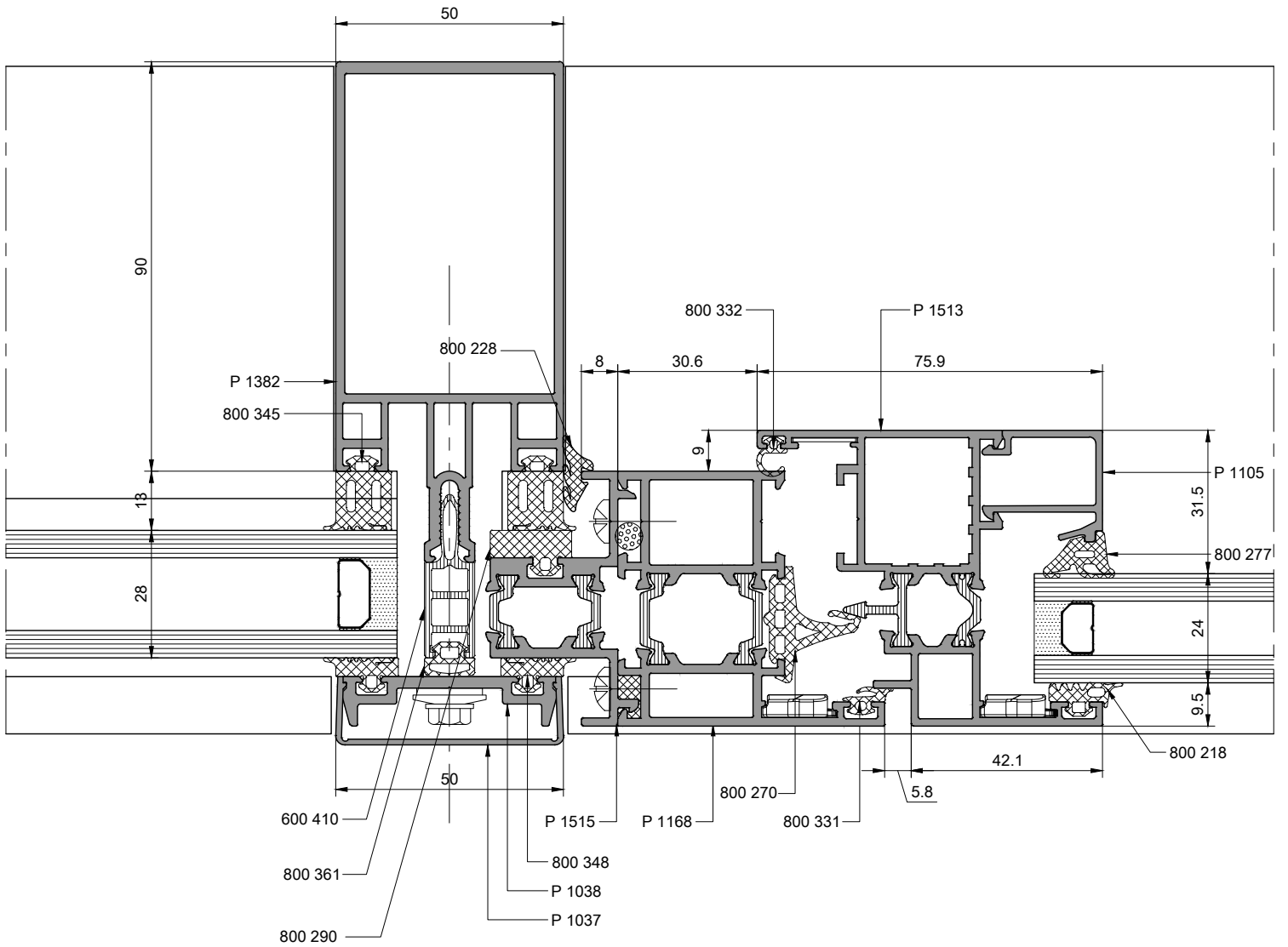
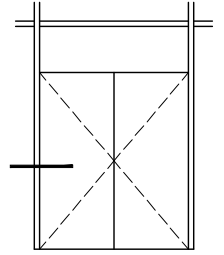

Daha fazla bilgi için BASIC56
kataloguna bakınız
to get more information please
have a look at BASIC56 catalogue
G61

FS50
STICK GİYDİRME CEPHE SİSTEMİ
STICK CURTAIN WALL SYSTEM

KAPAKLI CEPHE
İÇİ BASIC60
PENCERE BİRLEŞİM DETAYLARI
CAPPED FACADE DETAILS WITH BASIC60
WINDOW SYSTEM

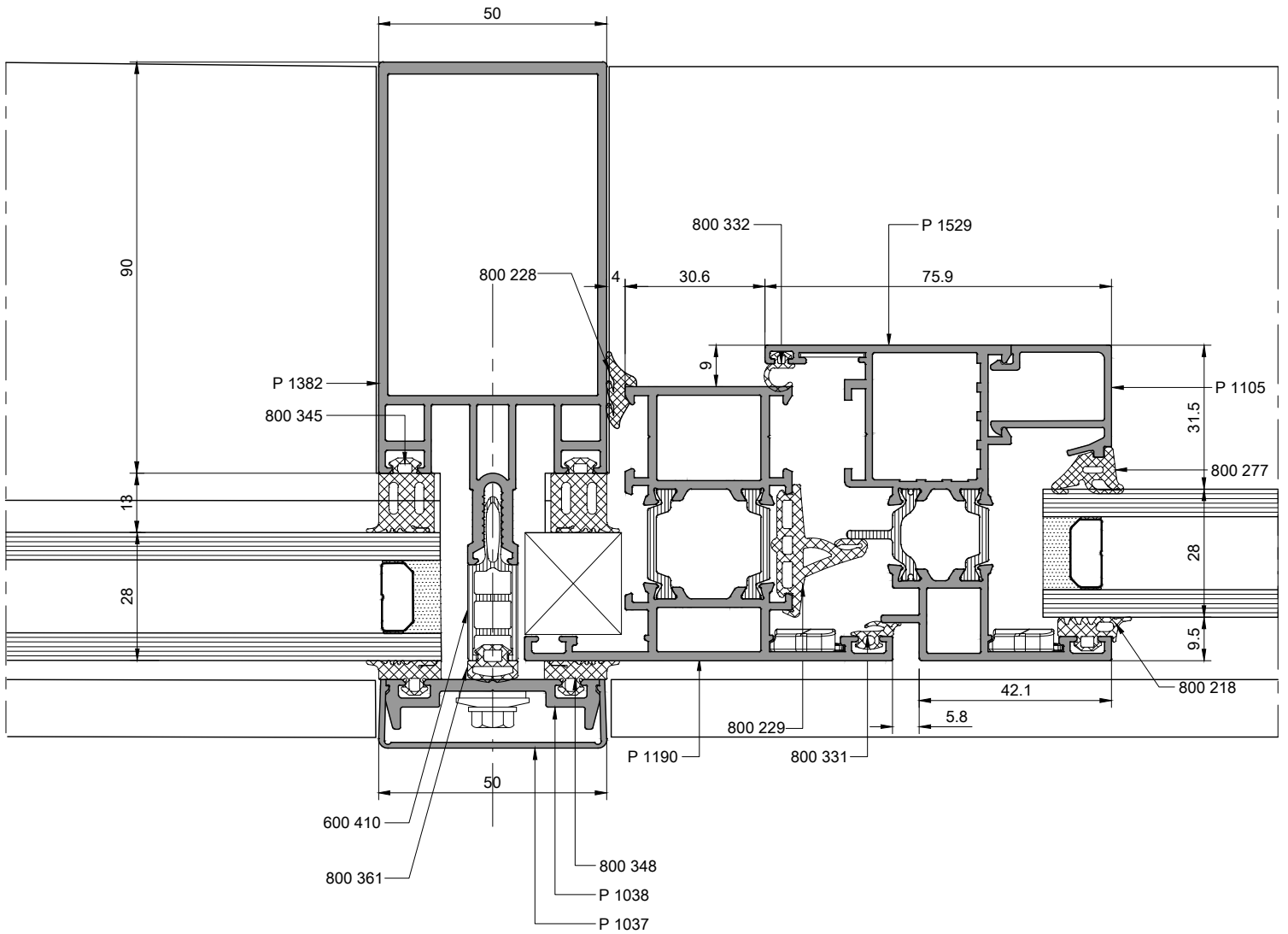
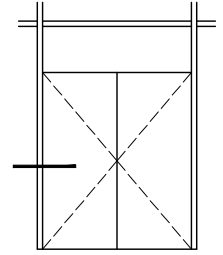

Daha fazla bilgi için BASIC60
kataloguna bakınız
to get more information please
have a look at BASIC60 catalogue
G62

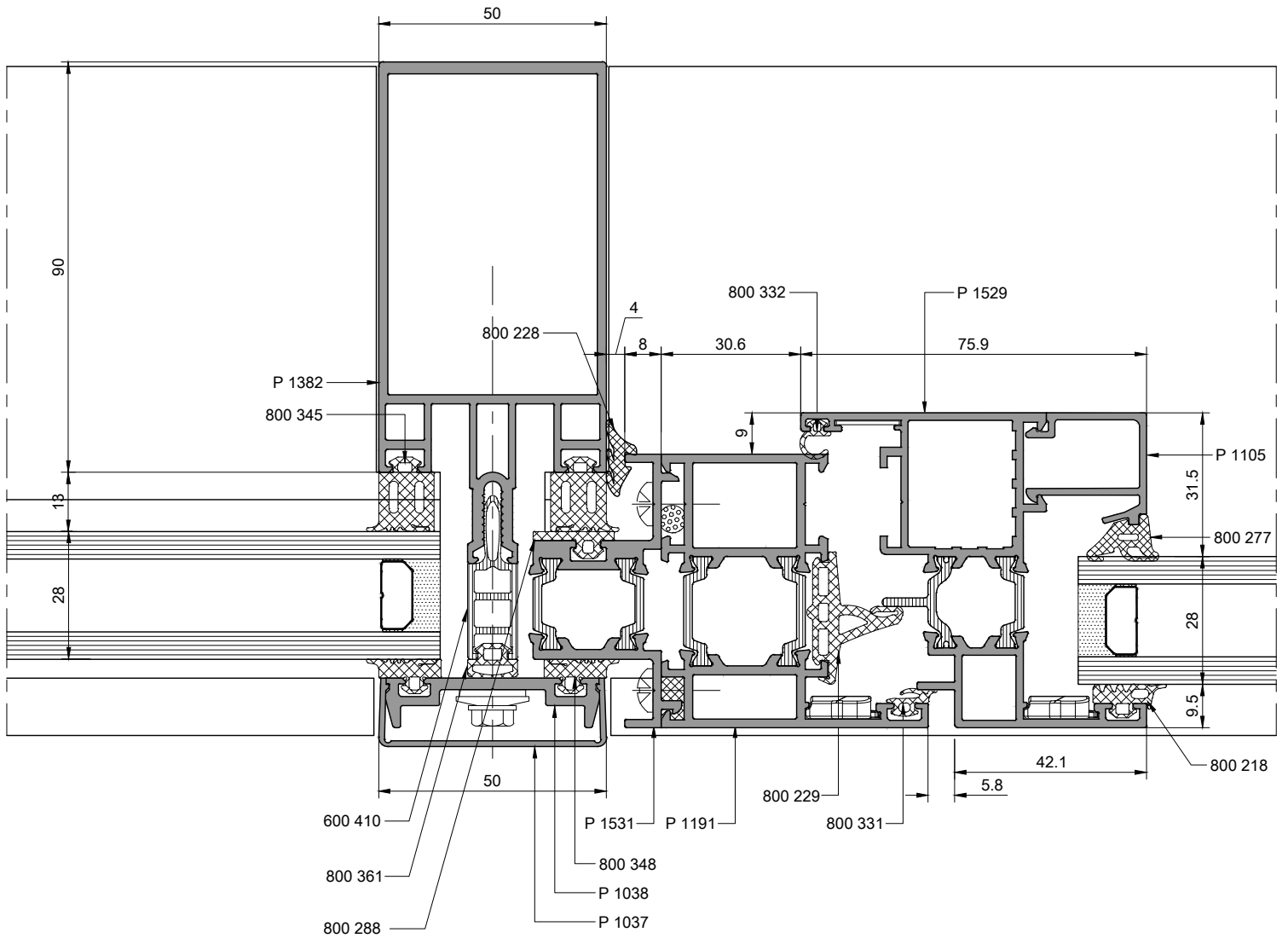
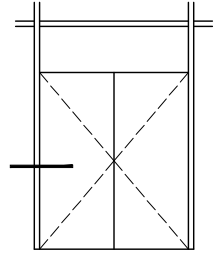

Daha fazla bilgi için BASIC60
kataloguna bakınız
to get more information please
have a look at BASIC60 catalogue
G63

FS50
STICK GİYDİRME CEPHE SİSTEMİ
STICK CURTAIN WALL SYSTEM

KAPAKLI CEPHE
İÇİ ICON70
PENCERE BİRLEŞİM DETAYLARI
CAPPED FACADE DETAILS WITH ICON70
WINDOW SYSTEM

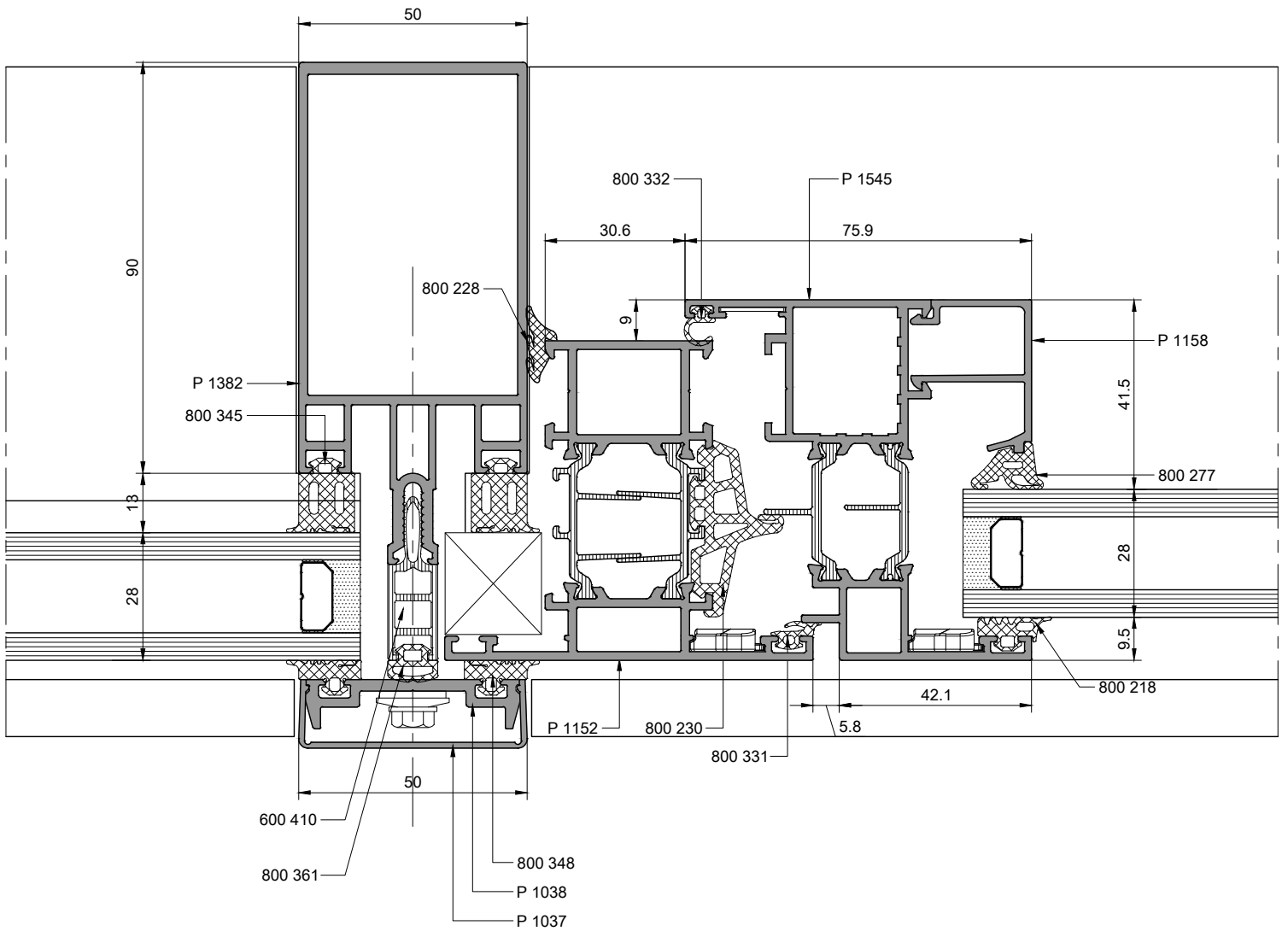
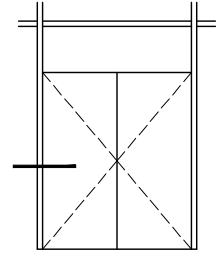

Daha fazla bilgi için ICON70
kataloguna bakınız
to get more information please
have a look at ICON70 catalogue
G64

